

PERFECT SOLUTIONS FOR GAS ALARM SYSTEMS

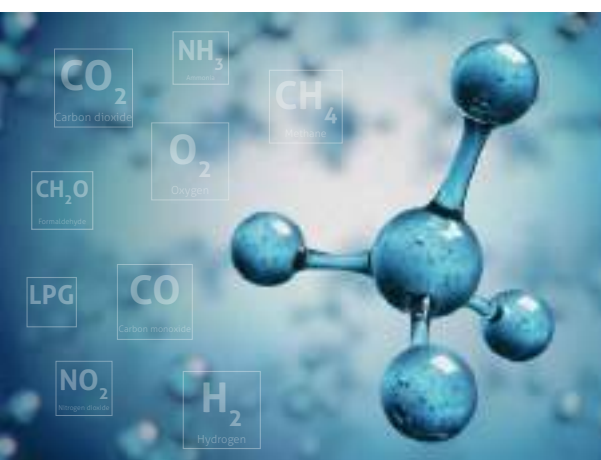

Catalog 2021



Fixed Gas Alarm Systems

for Buildings, Industry, Marine
and Analysis





Fixed Gas Alarm Systems

Developed and manufactured for sustainable protection

MSR-Electronic develops and produces reliable gas alarm systems that permanently monitor the ambient air and thereby protect human life and values.

MSR-Electronic offers a broad spectrum of methods for the detection of gases. On this basis MSR-Electronic develops individual gas sensors and systems for many applications where toxic or combustible gas concentrations can form. The interaction of the components of MSR-Electronic enables fast and reliable moni-

toring. This not only limits possible sources of error, but also reduces the planning effort and installation costs.

The products of MSR-Electronic meet and even exceed the important European standard EN 50545.



Safety First: MSR-Electronic offers extended safety and observes more than the worldwide standards.

With the Values

of a family-owned company

The globally operating company MSR-Electronic combines modern corporate management with the values of a family business. Through its global sales network, MSR-Electronic has long standing customer relationships that are characterized by reliability and mutual trust. When you choose the safe solutions and innovative

products of MSR-Electronic, you benefit from many advantages such as quality and availability, competitiveness of the products, responsibility towards customers and business partners as well as openness to new requirements.



Worldwide distribution

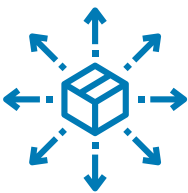

Innovative products



Customer-oriented development

References

worldwide in all industries



Audi



PORSCHE





PolyGard[®]2

Gas Alarm Systems for Buildings

Extended Safety

Intelligent Parking Guidance Systems



PolyXeta[®] 2

Gas Alarm Systems for Industrial Plants



PolyMarine

Gas Alarm Systems for Shipping



PolySam[®]

Gas Alarm Systems for Gas Analysis



Appendix



10	Certificates and Approvals
12	Applications
32	Sensors and Boards
48	Controllers and Modules
62	Software and Tools
64	Warning Devices and Accessories
68	Control Box
70	MSR-Cloud
72	Extended Safety
80	Intelligent Parking Guidance Systems

84	Certificates and Approvals
86	Applications
98	Sensors
104	Controllers and Modules
108	Warning Devices

112	Private Shipping
114	Commercial Shipping

118	Gas Analysis System for Process Optimization
-----	--

122	MSR-Academy
124	The MSR-Product Configurator and Webshop
126	OEM Customizing
128	HOW TO: The Video World
130	Products, Options and Housings
160	Product Matrix
162	Product Directory
164	Worldwide sales
166	MSR-Group

PolyGard®2

Gas Alarm Systems for Buildings

Gas warning systems or gas alarm systems must be reliable at all times. In the event of gas leaks, e.g. carbon dioxide (CO₂), carbon monoxide (CO) or nitrogen oxides (NO_x), fast alerting and reliable products are required. The sensors, controllers and warning devices

from MSR-Electronic effectively protect human beings and systems in dangerous situations where combustible or toxic gases are emitted. With the help of modern communication technology, it is possible to react quickly.

+ BENEFITS

- **More safety**
More than required by all national standards
- **Exchangeable sensor with X-Change technology**
Significantly lower maintenance costs
- **Precise planning capability with overall reduced costs**
- **Integration in BMS/GLT**
(BACnet, Modbus)





Certificates and Approvals

Safety for all applications

The products of MSR-Electronic comply with more than the general standards and regulations and can therefore guarantee the safety of the system.

When handling hazardous substances, special safety precautions are mandatory. This is especially true in the chemical industry, where many different hazardous substances are used.

MSR-Electronic provides innovative sensors and controllers to detect and immediately display life-threatening gases.

The products, services and training courses are based on many years of experience and have been put together with a lot of know-how and individual customer requirements.

The sensors of MSR-Electronic continuously monitor the air for combustible and toxic gases and oxygen.



Buildings: Approvals for PolyGard®2

Measurement function test of sensors and advices according to EN 50545 (TÜV-Rheinland)

Device series types: DGC-06, GC-06, EP-06, SB2, MSC2, MSB2, SC2-Tox, SC2-Ex

Functional test (SIL) of sensors and devices according to EN 50271 chapter 4.7 (TÜV-Rheinland)

Device series types: DGC-06, GC-06, EP-06, SB2, MSC2, MSB2, SC2-Tox, SC2-Ex

Approvals: ANSI/UL 61010-1, CAN/CSA-22.2 No. 61010-1

Device series types: DGC-06, GC-06, EP-06, SB2, MSC2, MSB2, MGC2, WSB2, ARB2, SC2-Tox, SC2-Ex, MC2-Tox, MC2-Ex

Further conformities: EU Directive 2014 / 30 / EU and 2014 / 35 / EU, EN 61010-1, EN 50270, EN 378, EN 60079-29-1, EN 45544-1, EN 50104, EN 50402, EN 14624, EN 61508-1 -2 -3, EN 50271, ISO 9001, EAC-Metrological approval



Garage, Tunnel, Loading Zones

Your protection against CO / NO₂ / LPG

MSR-Electronic offers reliable sensors, controllers and warning devices for parking garages, tunnels and loading zones.

Garages and tunnels above a certain size (regulations vary from region to region) require a gas warning device that ensures at least carbon monoxide monitoring. Here the requirements of EN 50545 must be met. These relate to speed and accuracy as well as to the way the system should react to gas. The standard also specifies the value at which the system triggers an alarm and which warning devices must be used.

MSR gas sensors reliably protect people and systems in these areas. MSR-Electronic is one of the few companies that is certified according to EN 50545. In addition, thanks to flexible setting options, the gas warning system can be precisely adapted to the respective regulation (e.g. switching thresholds vary depending on the federal state).



BENEFITS

- DGC-06 controller to manage up to 128 sensors for large parking garages
- Compactcontroller for the management of up to 10 sensors for small parking garages
- MSC2 controller for managing up to 3 sensors for small parking garages
- Controller also suitable for control cabinet installation
- Easy digital calibration
- Easy replacement of the old system
- Housing protection type IP65
- Air quality monitoring in the tunnel
- Easy communication with BMS, GLT
- Compliant with EN 50545 and EN 50271



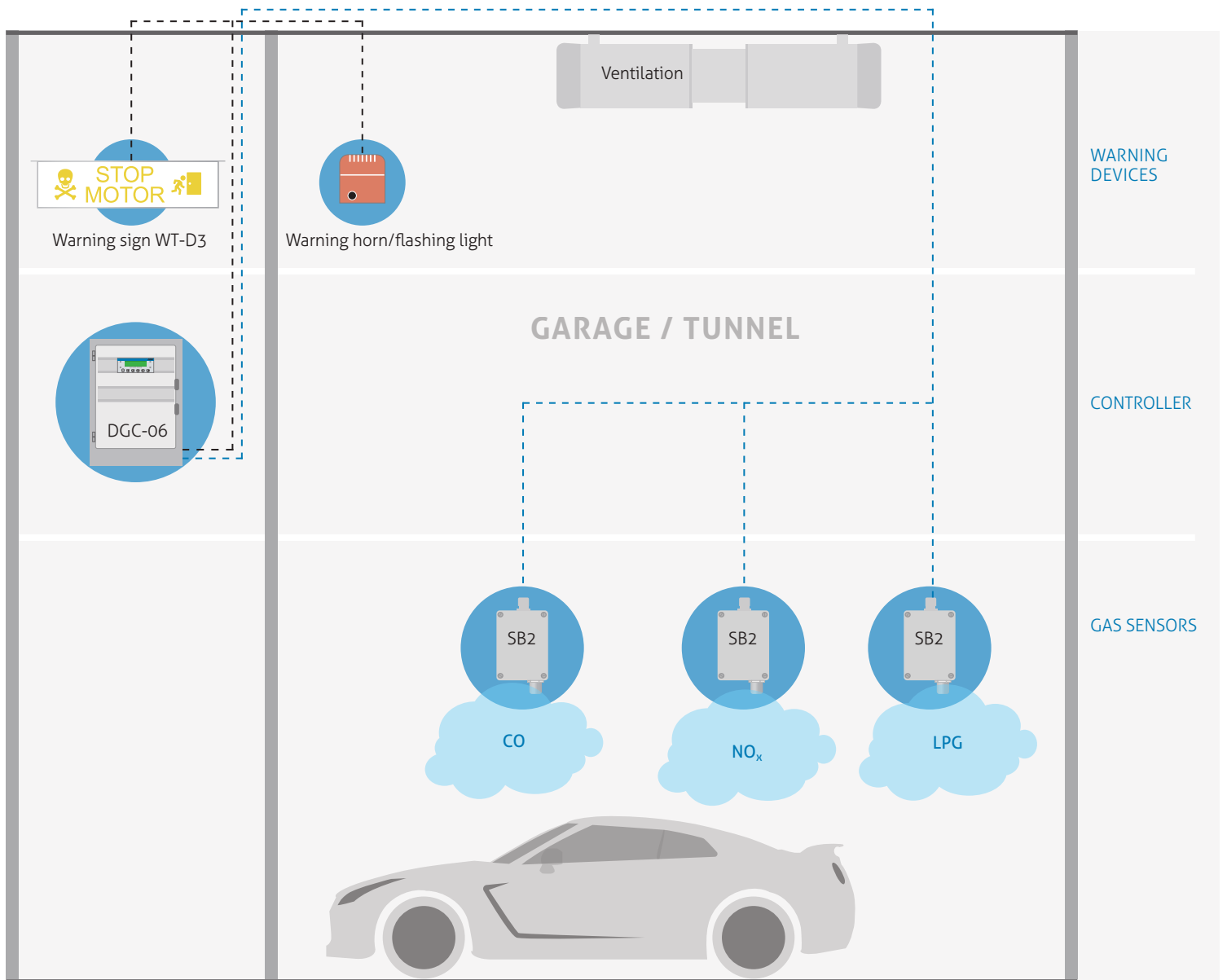

MSRSHOP24

Configure your product here: www.msr-24.com

Refrigeration Systems

Your protection against refrigerants

MSR-Electronic offers reliable sensors, controllers and warning devices for refrigeration systems.

Refrigeration systems above a certain size must be equipped with a gas warning device. The requirements for gas detectors depend on the type of refrigerant and the specific application. The requirements of EN 378 and EN 14624, among others, apply here. The European standard specifies the requirements for the safety of persons and property. MSR gas sensors are safer than the standards require

and reliably protect life and system. The gas detection system from MSR-Electronic can be adapted exactly to the respective regulations (e.g. switching thresholds) thanks to flexible setting options. Depending on the number of sensors required, the large DGC-06 MSR controller or a stand-alone MSC2 controller is used.

+ BENEFITS

- DGC-06 controller to manage up to 128 sensors for different refrigerants
- Compactcontroller for the management of up to 10 sensors, completely operable via the display
- MSC2 controller for the management of up to 3 sensors in combination with the GC-06 or as a stand-alone device, has 3 potential-free relays
- Easy and fast calibration of digital and analog sensors
- Compliant with EN 50545, EN 50271 and EN 378



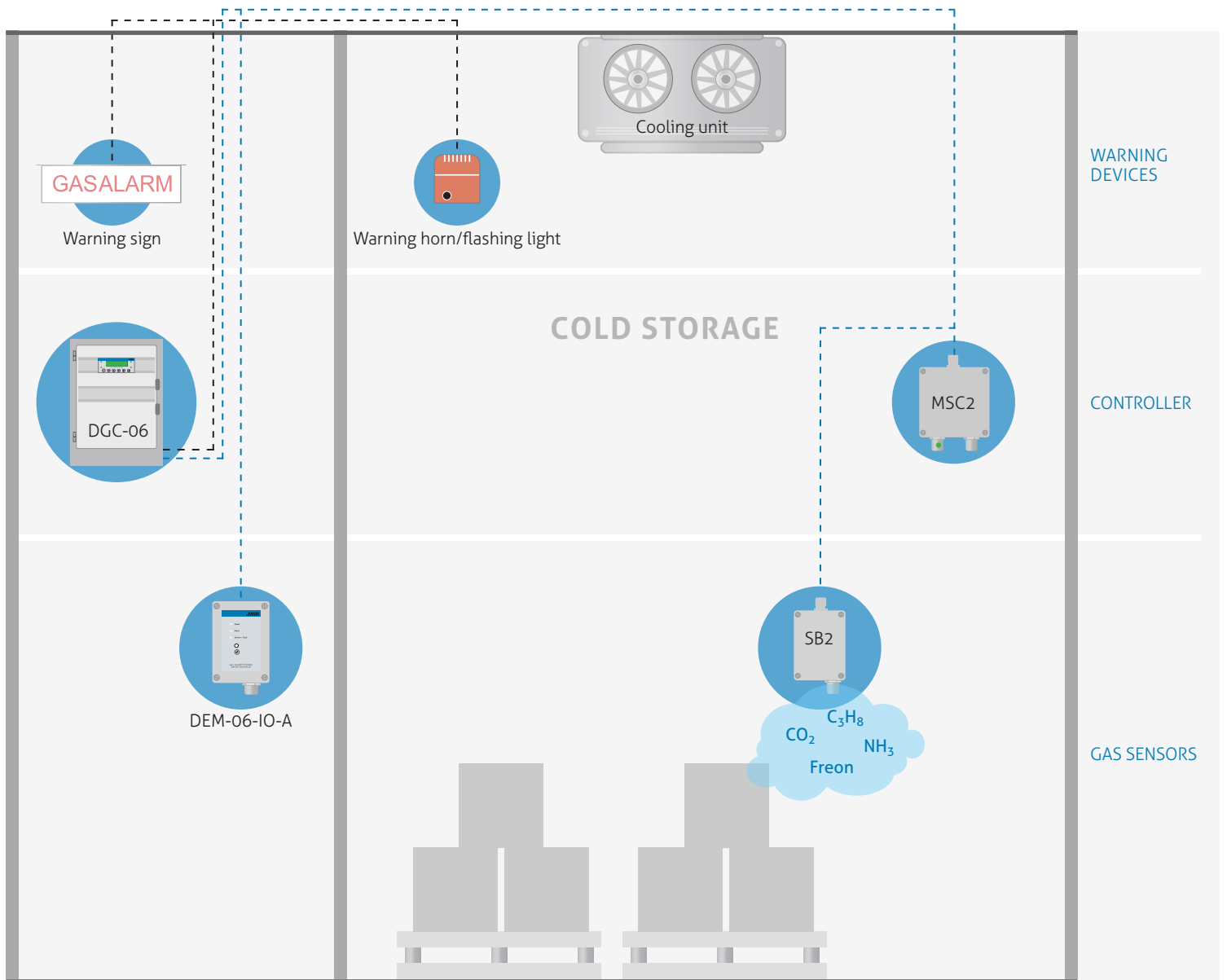

MSRSHOP24

Configure your product here: www.msr-24.com

VRF/VRV Systems

Reliable protection against refrigerants

VRF/VRV air conditioning systems can be found in many hotels and offices. The risk: High concentrations of refrigerants in the room can cause suffocation.

If there is a leak in an air conditioning system, there is the risk that the entire quantity of the refrigerant in the system will leak into the corresponding room. The WSB2-VRF unit makes your VRF/VRV system a safe bet. The WSB2-VRF ensures refrigerant monitoring in

closed rooms where leaks may occur and displays an increased gas concentration in real time. With the second integrated sensor you also keep an eye on the air quality. This ensures perfect safety and the safety of the guests.



BENEFITS

- Flat construction and an aesthetic, unobtrusive design
- Centralized or decentralized systems possible by using the WSB2 board
- Up to 96 sensors can be connected to one GC-06 controller
- 2 sensors per WSB2 possible
- Easy and fast calibration of digital and analog sensors
- Conform to EN 378



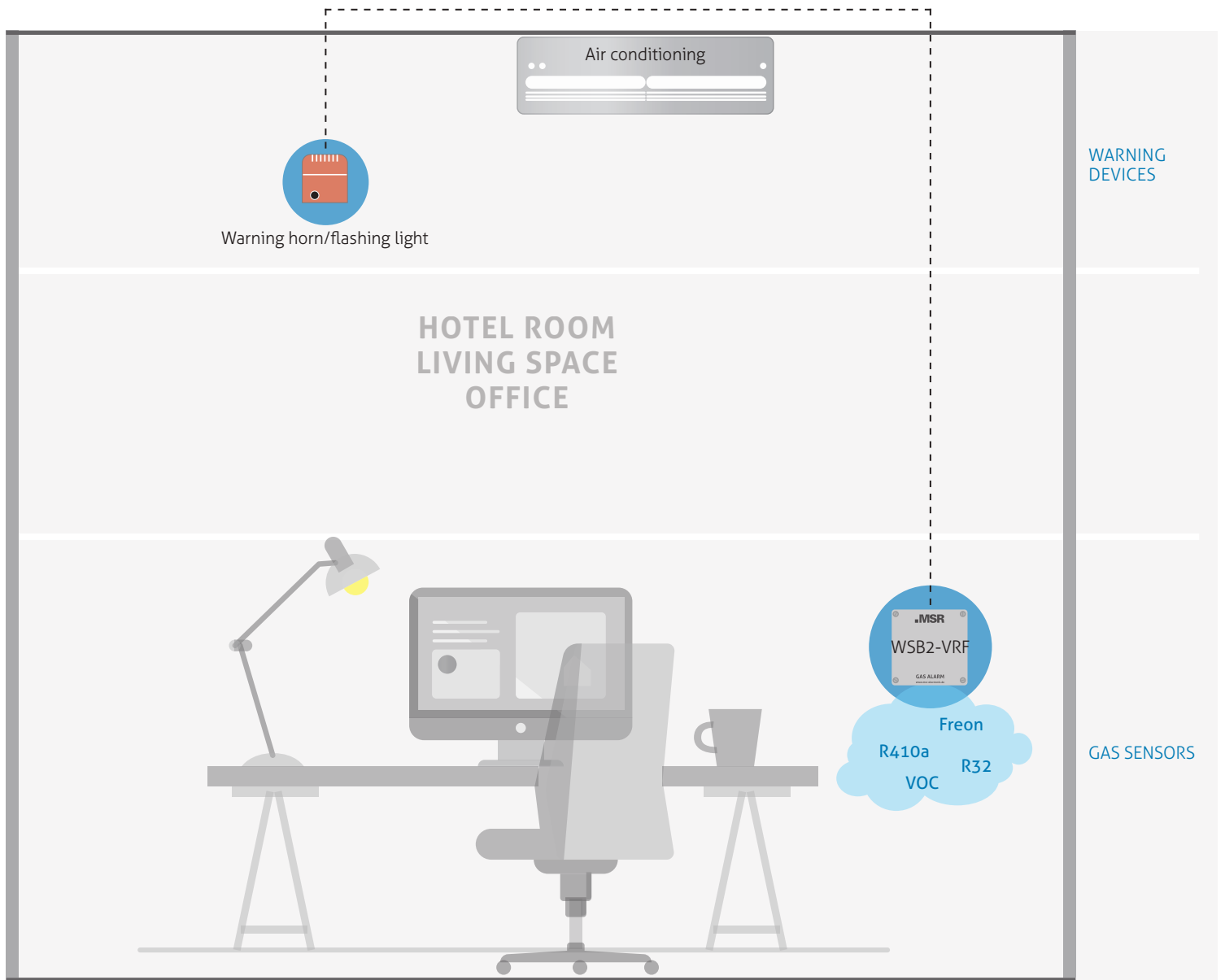

MSRSHOP24

Configure your product here: www.msr-24.com

Dispensing Systems

Your protection against CO₂ poisoning and O₂ deficiency

MSR-Electronic offers reliable sensors, controllers and warning devices for beverage and cooling systems.

The sensors can be used in restaurants, breweries and fermenting cellars, breweries, wineries, beverage bottling systems, but also in CO₂ extinguishing agent systems in warehouses and production halls, wherever CO₂

bottles, lines and tanks are required. The DEM-06-IO-A module ensures access to enclosed spaces where CO₂ leakage can occur and displays increased gas concentration in real time. Thus, safety is perfectly guaranteed.



BENEFITS

- Safety product: More than required by all national standards
- LED display: Warning before entering the room
- Integrated test and maintenance function
- Plug & play
- Optionally also for several entrances: Parallel warning for the respective door
- Conform to EN 378



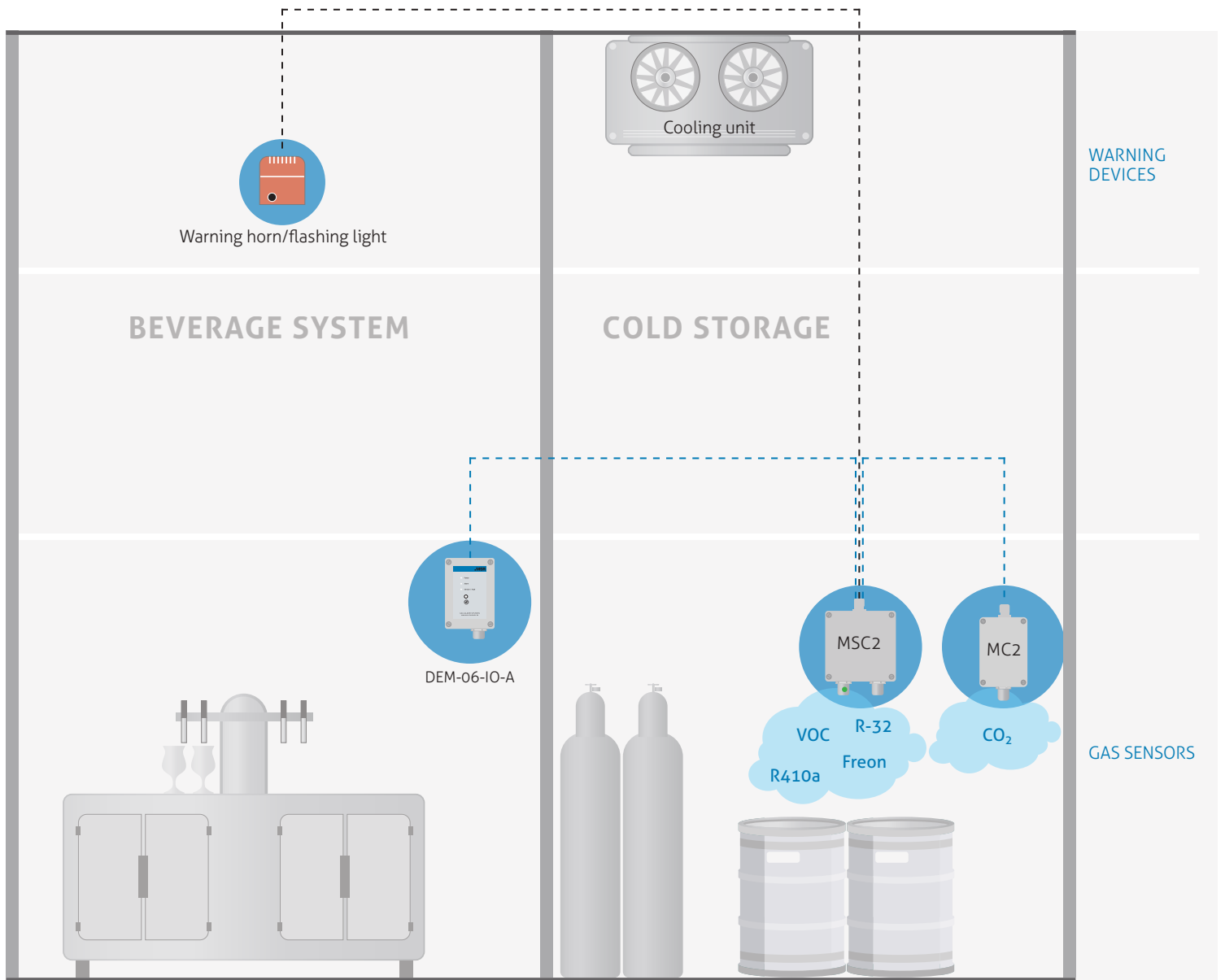

MSRSHOP24

Configure your product here: www.msr-24.com

Laboratory and Medicine

Detection of different gases

Gas warning systems from MSR-Electronic are particularly flexible in use, as all requirements can be taken into account in a customized manner.

When handling various hazardous substances in laboratories and medical facilities, relevant safety measures must be observed in accordance with the Hazardous Substances Ordinance (GefStoffV) and the laboratory guideline. Materials are produced, examined and monitored in production processes. For this purpose, mixtures of substances are separated, substances are detected and chemical reactions and measurements are carried out. Reliable monitoring of the large number of gases in

the ambient air must therefore be ensured. The Compactcontroller from MSR-Electronic is designed for the connection of up to 10 gas sensors via its own field bus and is used to warn of different gases. Multiple output and input options allow easy integration into existing systems.

MSR-Electronic also provides reliable solutions for extended applications, e.g. for large capacity laboratories.



BENEFITS

- Plug & play
- Display for all notification, configuration and calibration functions (no tool necessary)
- Automatic closing of the gas magnetic valves in the case of a gas alarm
- Fieldbus connection for up to 10 gas sensors (SB2Units)
- Hardware and software according to SIL-compliant development process
- Modular technology (pluggable and exchangeable), reverse polarity and overload protected
- 3 relays, 2 transistor outputs, 2 digital inputs, various housing types with IP65
- Warning buzzer and status LED for warning, fault, operation and service (optional)





PDF DOWNLOAD

Here you can see the complete folder: Safe Medical and Laboratory Areas

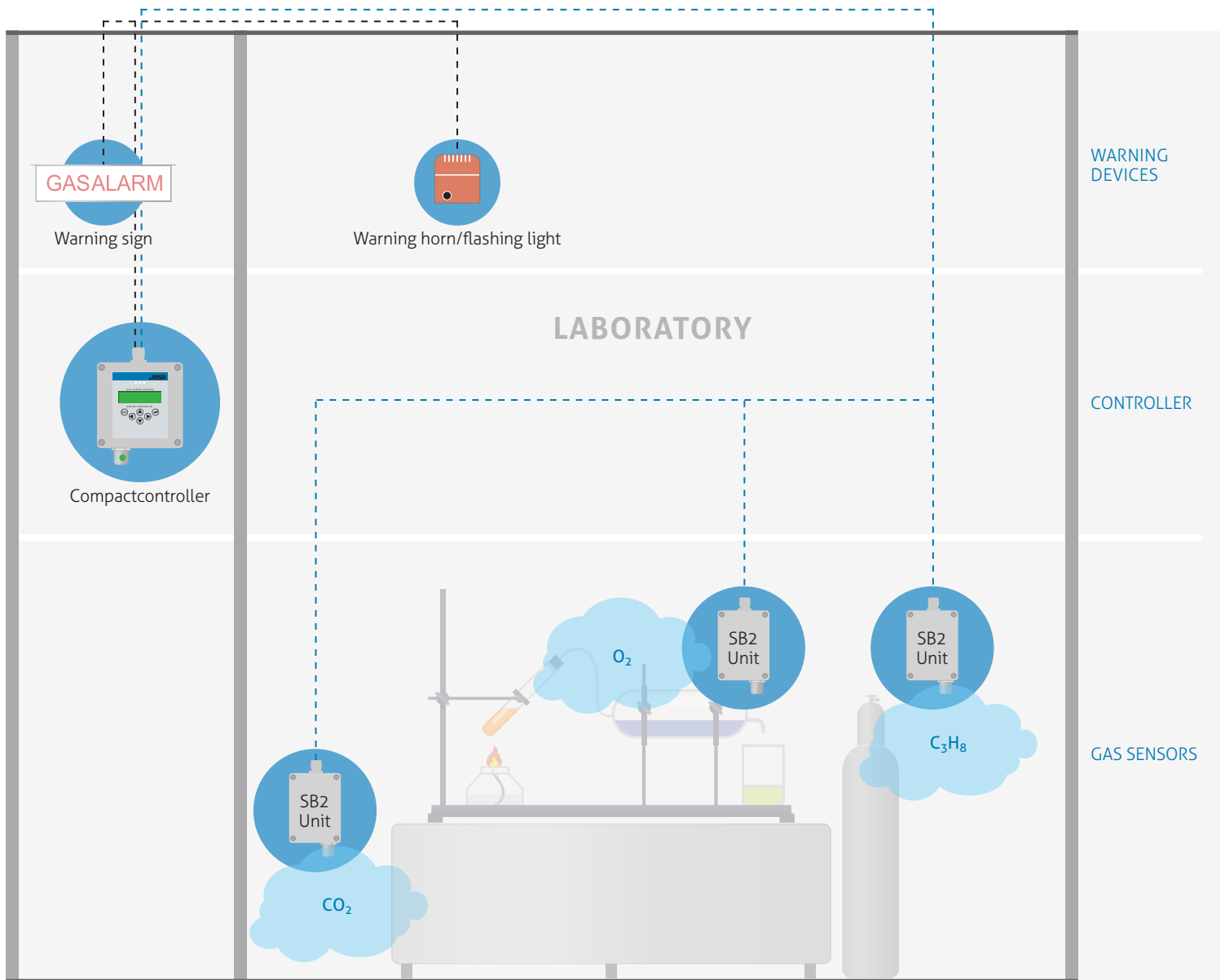

MSRSHOP24

Configure your product here: www.msr-24.com

Ripening Chambers

Your safety against CO₂ / C₂H₄ / C₂H₄O and O₂ deficiency

Fresh fruit and vegetables are alive and continue to breathe after the harvest. This leads to oxygen consumption and the formation of carbon dioxide and water vapour. Keeping the products fresh means slowing down the process while maintaining the quality of the product. Gas sensors are just as important as the modern technology of the ripening chambers. They are required to permanently monitor the various gas concentrations involved in the ripening

process. The sensors, controllers and warning devices from MSR-Electronic protect people and equipment effectively and monitor the system as a central point of the entire process. Modern communication technology makes it possible to react quickly. The innovative Compactcontroller from MSR-Electronic is designed for connecting up to 10 gas sensors via its own field bus, serves to warn of various gases and is therefore ideal for the application.

+ BENEFITS

- Display for all notification, configuration and calibration functions (no tool necessary)
- Fieldbus connection for up to 10 gas sensors (SB2Units) with max. 900 m length
- Hardware and software according to SIL-compliant development process
- Modular technology (pluggable and exchangeable), reverse polarity and overload protected
- Internal function monitoring with integrated hardware watchdog
- 3 relays, 2 transistor outputs, 2 digital inputs
- Different housing types with IP65
- Warning buzzer and status LED for warning, fault, operation and service (optional)
- Operating voltage 230 V AC, with wide range input 100 to 240 V AC (optional), UPS (optional)
- Conform to EN 378



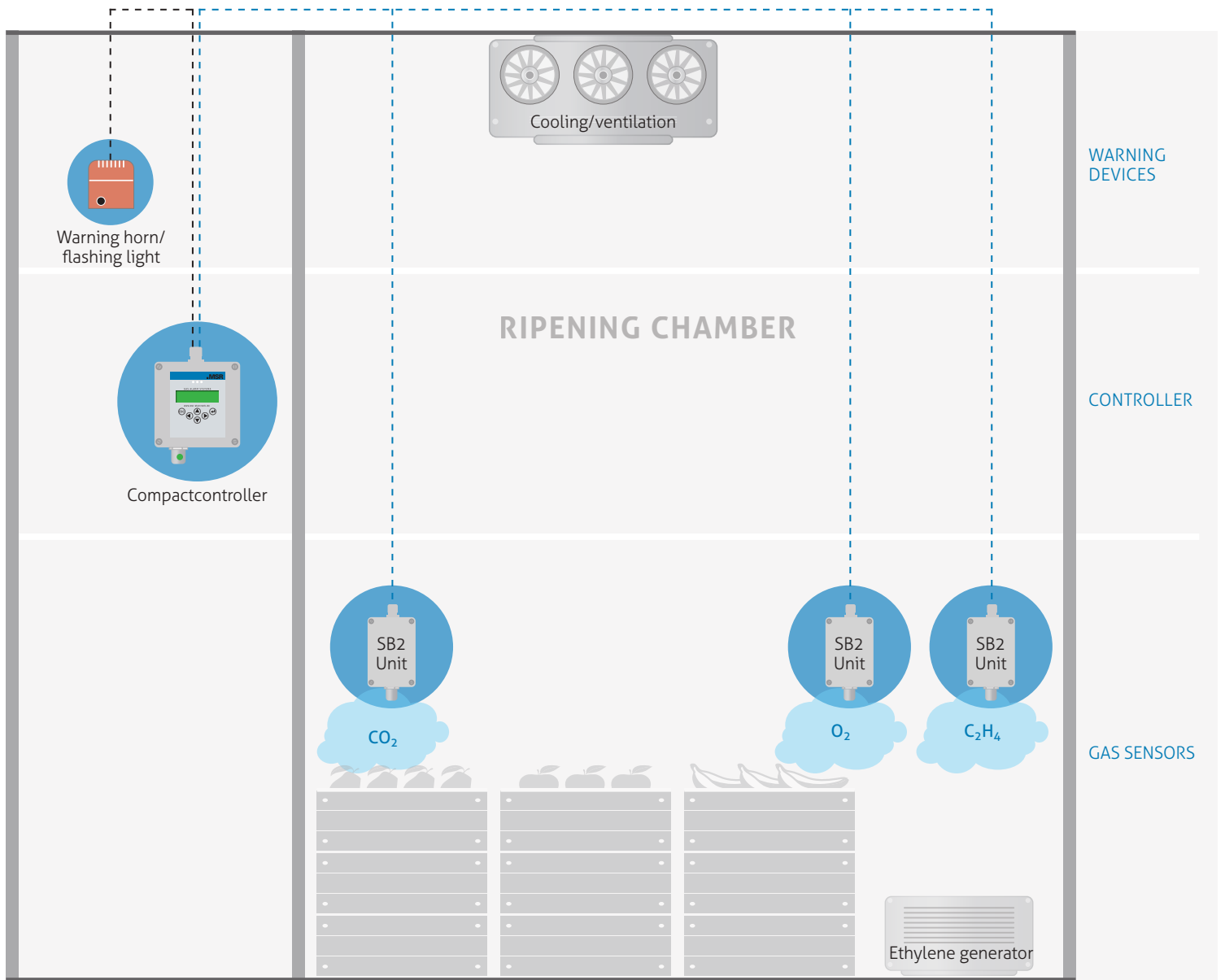

MSRSHOP24

Configure your product here: www.msr-24.com

Vending Machines

Your safety in case of a refrigerant leakage

MSR-Electronic offers reliable sensors, controllers and warning devices for vending machines with cooling systems.

The global market is moving away from classic refrigerants with high global warming potential (GWP) and the use of natural refrigerants is increasing. Due to the higher flammability of natural gases such as propane, installations

must therefore be protected with gas alarm systems. For this purpose MSR-Electronic offers the SSAX1 sensor, which can be easily integrated into vending machines and reliably detects any gas leakage.



BENEFITS

- ATEX and IECEx certificates for electrical explosion protection
- SSAX1 for zone 1 and zone 2 applicable
- Continuous monitoring
- Sensor with long life time (infrared: > 5 years)
- Low zero drift
- High accuracy, selectivity and reliability
- Simple and fast recalibration by exchanging the sensor cartridge
- Reverse polarity and overload protection
- Immediate shutdown of the vending machine in case of gas leakage
- Conform to EN 378





Warning horn/flashing light

VENDING MACHINE

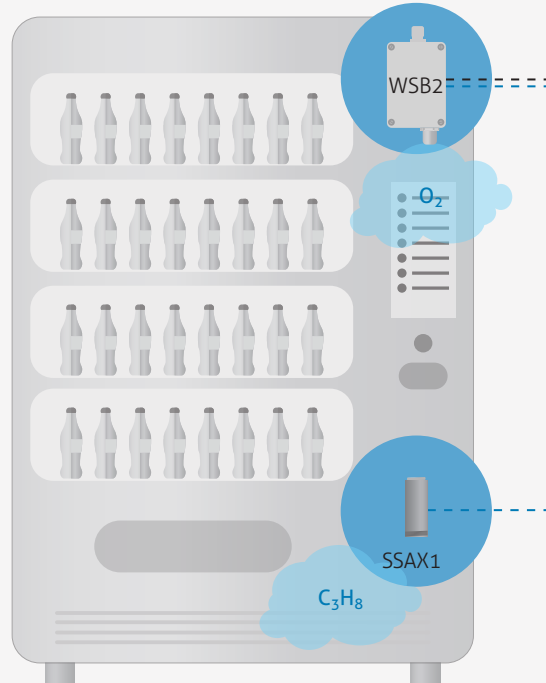

WARNING DEVICES

GAS SENSORS



MSRSHOP24

Configure your product here: www.msr-24.com

Additional Applications

Safer applications for buildings

OFFICE AND PRODUCTION AREA

Protection against these gases: VOC / O₂ / CO₂

The gas sensors are used for monitoring the air quality in offices or to monitor CO₂ leakage in production areas. For monitoring the air quality, the gas alarm systems by MSR-Electronic permanently measure the ambient air and reliably detect all harmful gases and vapors.

WATER TREATMENT

Protection against these gases: Cl₂ / O₃ / CO₂ / O₂

The gas sensors are used for leakage monitoring of chlorine or ozone systems, for the protection of persons and machines, in swimming pools of any size. The fixed gas measuring technology of MSR-Electronic always and reliably detects harmful gases and vapors in the ambient air.

HEATING SYSTEMS

Protection against these gases: CH₄ / Methane (natural gas)

MSR-Electronic offers reliable sensors, controllers and accessories for heating systems. The EX sensors are used for leakage monitoring of the supply lines in gas heating systems as well as in gas distribution systems.



REPAIR SHOPS

Protection against these gases: CO / NO_x / LPG

Whether in car or truck workshops: the sensors are used to monitor harmful gases and vapors. Whether exhaust gases, welding fumes, paint fumes or leaking gas cylinders, the sensors always detect reliably and consequently protect human beings and equipment.

BREWERIES AND WINE CELLARS

Protection against these gases: CO₂ / SO₂ / H₂S / CO / C₂H₆O

The MSR-Electronic monitoring system makes the system a safe thing. The system detects CO₂ leaks and ensures access. Optical and acoustic alarm devices warn in case of danger. This ensures perfect safety.



PolyGard®2





MSR
**SAFETY
FIRST**

PolyGard[®]2

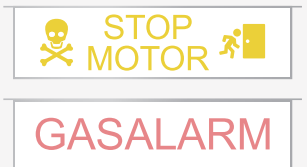
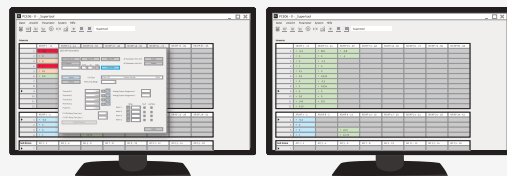
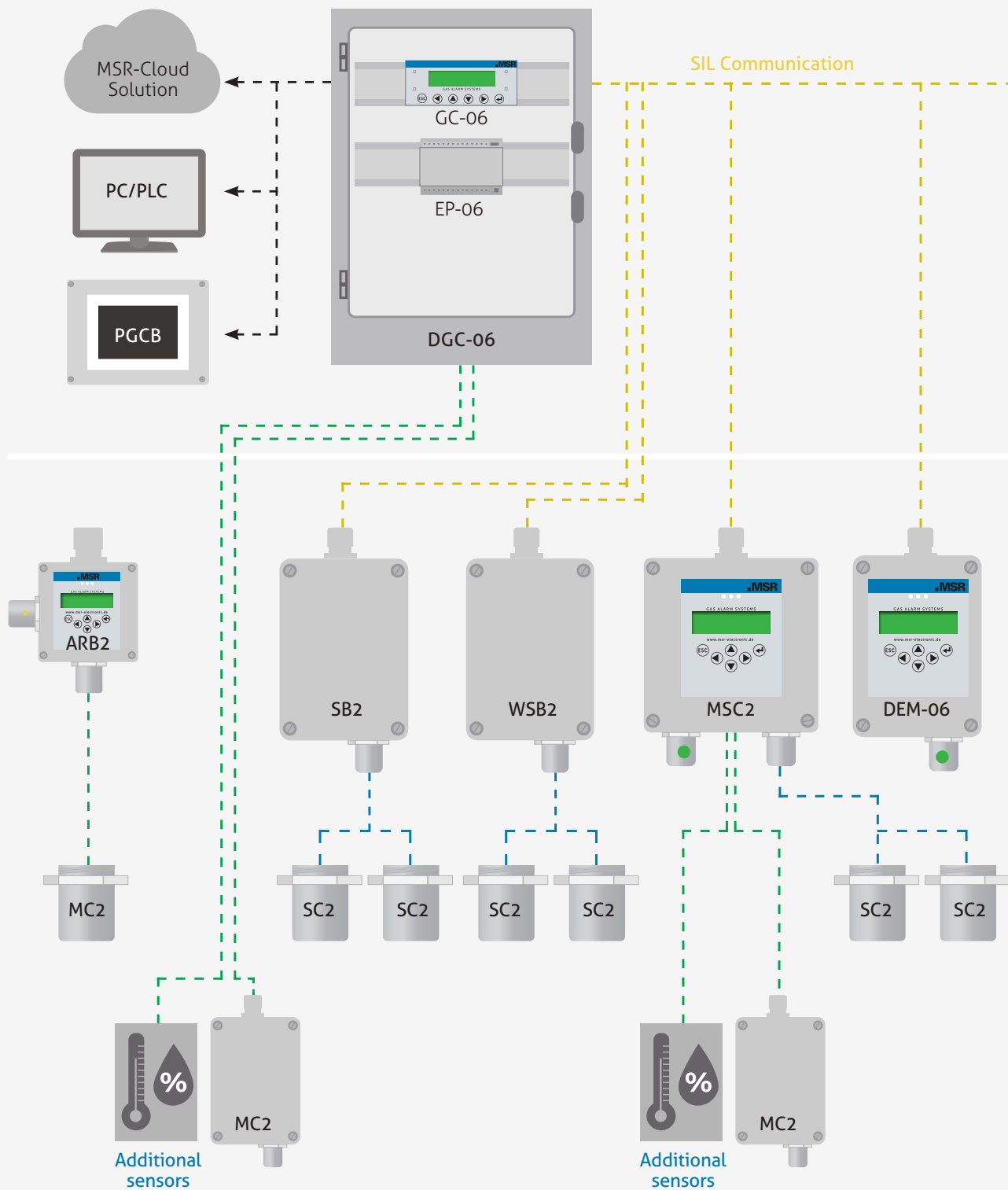



CONTROLLER

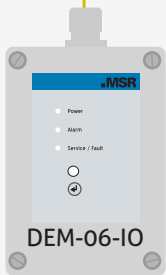
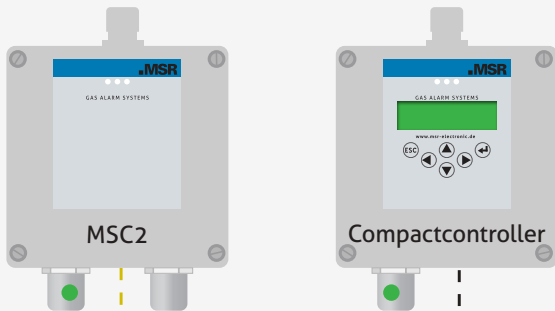

GAS SENSORS & BOARDS

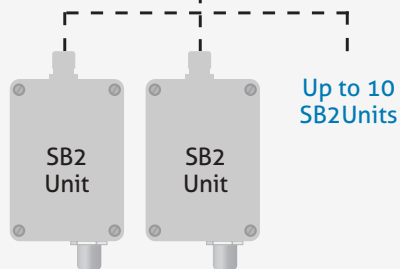

- - - SIL
RS-485
DGC-Bus
- - - Digital
L-Bus
- - - RS-485
Modbus
BACnet
- - - Analog
4-20 mA

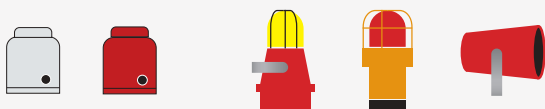

WARNING DEVICES & ACCESSORIES

Sensor Head SC2 / MC2

With X-Change technology

Exchangeable sensor heads with digital and analog output signal.

MSR-Electronic develops individual gas sensors, e.g. for CO₂, CO, CH₄, CH₂O, NH₃, O₂ or H₂ and systems in which toxic or combustible gas concentrations can form. These are integrated into complex warning systems and are used, for example, in parking garages, biogas plants, refrigeration systems, petrochemical industrial plants, breweries and dispensing systems or in laboratories and medical applications as well as in hydrogen production and processing.

The sensors SC2 and MC2 include the sensor element and the measuring amplifier as well as

a μ Controller for measured value processing. In this way, different data can be processed and used, such as the temperature for compensation of the measured value. Calibration interval and errors are also monitored and transmitted to the evaluation unit.

Thanks to the X-Change technology, calibration can be carried out by simply changing the sensor head or using the integrated, convenient calibration routine directly on the system. The sensors are designed for connection to the MSR controllers and boards.



MC2 and SC2



Digital Sensor Head SC2

Connection L-Bus
max. 5 m away

Laser engraving type designation

Sensor cartridge housing IP65

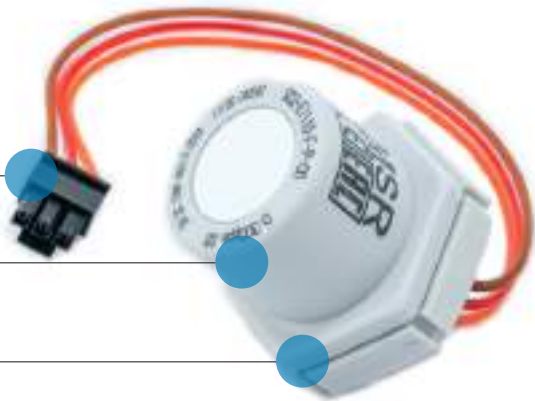

Analog Sensor Head MC2

Digital calibration

Sensor cartridge MC2
with 4-20 mA / 2-10 V output

Sensor cartridge housing IP65



MSRS24

Configure your product here: www.msr-24.com

Sensor Head SC2 / MC2

With infrared sensor element

Infrared exchange sensor for precise and selective measurement of gases.

For applications where durability and high precision measurement are important. The IR measuring method with integrated temperature compensation ensures highest accuracy, selectivity and reliability. In the μ Controller all data and measured values of

the sensor element are stored fail-safe and are digitally transmitted via the local bus to the sensor board SB2 or multi sensor board MSB2 or to the MSC2 or WSB2. The sensor cartridge automatically transmits information about the maintenance interval to the controller.



BENEFITS

- Long life expectancy
- Low maintenance costs
- High accuracy, selectivity and reliability
- Measuring value setting time $t_{90} < 30$ sec.
- Gilded mirror surface
- Low zero drift
- Sensor with long service life and high durability
- Running-in time until operation < 60 sec.

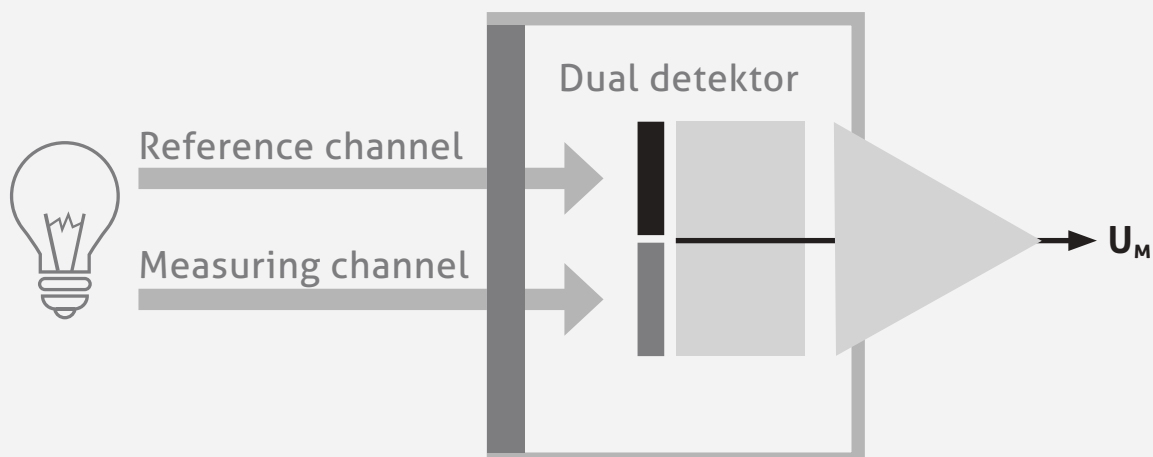

Sensor Head SC2 / MC2

With electrochemical sensor element

Application for toxic gases and coolants.

These sensors are used to measure mainly toxic gases such as CO, NO, NO₂ and function according to the electrochemical principle. This means that there is an electrolyte in a cell. It reacts proportionally to the presence of gas

with the formation of ions, which ultimately generates a current. This change then indicates the gas concentration. This principle has a high sensitivity and a fast reaction time, which is especially interesting for toxic gases.



BENEFITS

- High sensitivity
- Linear signal
- Low cross-sensitivity
- No energy is required
- Fast response time
- No poisoning by silicones

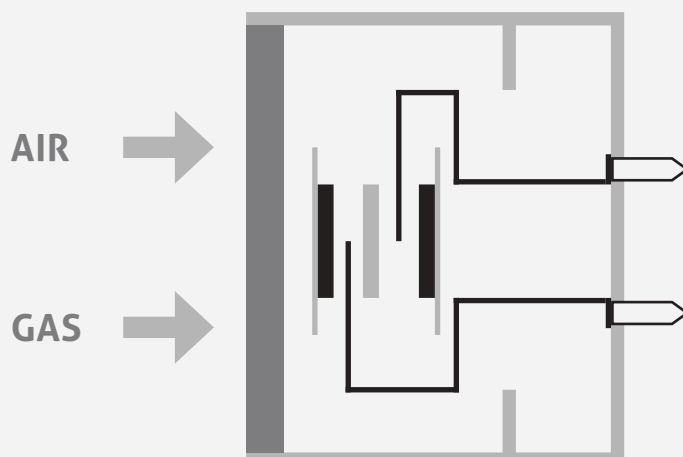

Sensor Head SC2 / MC2

With pellistor sensor element

Application for combustible gases and vapors.

Pellistors or catalytic sensors consist of an active and a passive pellistor. These form a Wheatstone bridge circuit, which is operated with a heating current of approx. 450 ° C. When gas is present, the resistance on the active side

changes, which generates a current flow. This method is particularly suitable for explosive gases, where high linearity and measuring accuracy is required.

+ BENEFITS

- Linear signal
- High measuring accuracy
- Temperature range -30 °C to 50 °C

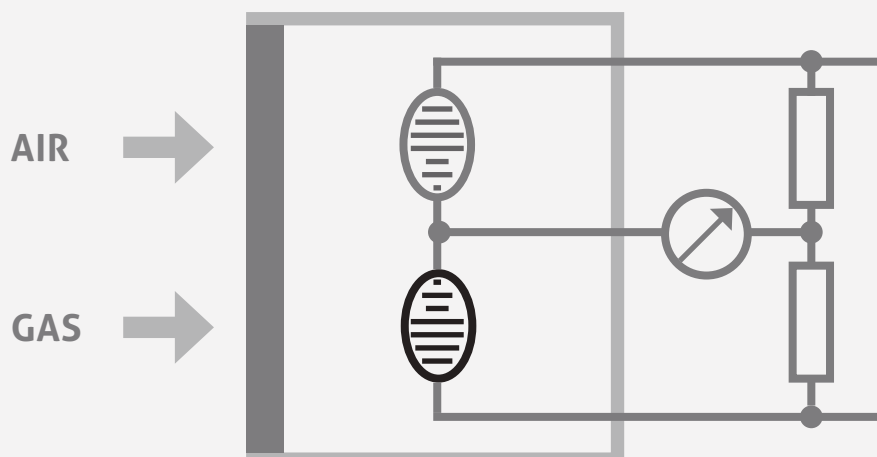

Sensor Head SC2 / MC2

With semiconductor sensor element

Available for combustible gases and freons.

Semiconductor gas sensors for gas detection are not made of silicon or germanium, but of N- or P-conducting metal oxides (e.g. zinc oxide, tin oxide, copper oxide). The measuring effect is based on the accumulation of certain gas atoms

on the surface of the semiconductor material, which causes a change in electrical resistance. These sensors are not very selective, but are excellent for leakage measurement.

+ BENEFITS

- Cost-effective
- Very good leakage measurement

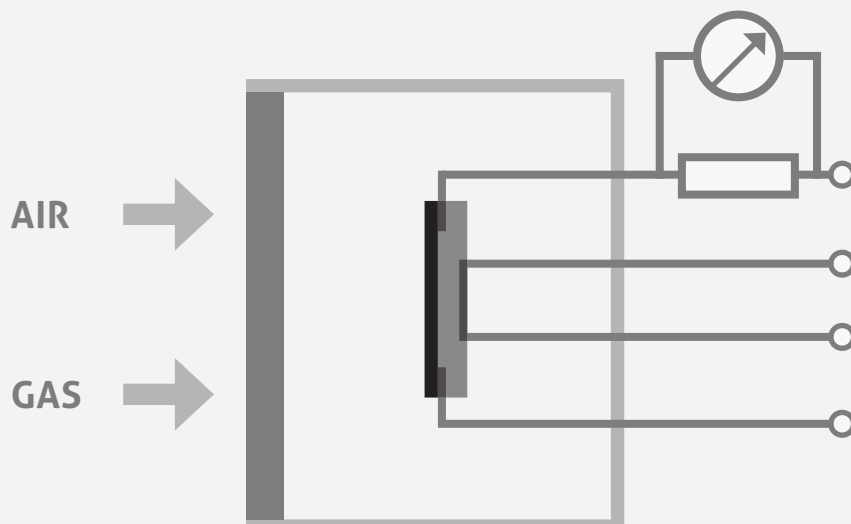

X-Change Technology

Exchangeable sensor SC2 and MC2

Time-saving calibration of MSR gas sensors.

Until now, the necessary calibration of the sensors was a complex procedure and dependent on an external certified company. This was very time-consuming and expensive. The sensors had to be opened, checked and calibrated with great care at the construction site. If an error was found, it was necessary

to take the complete sensor with you and replace it afterwards. With the new X-Change technology this effort can be saved. The exchangeable sensor cartridge can be replaced on site at any time. The transmitter therefore remains untouched. This saves time and costs.



EASY AND INDEPENDENT RECALIBRATION

- Significant time and cost savings
- Easy exchange process
- Delivery of recalibrated sensor cartridges
- Increased safety for your system

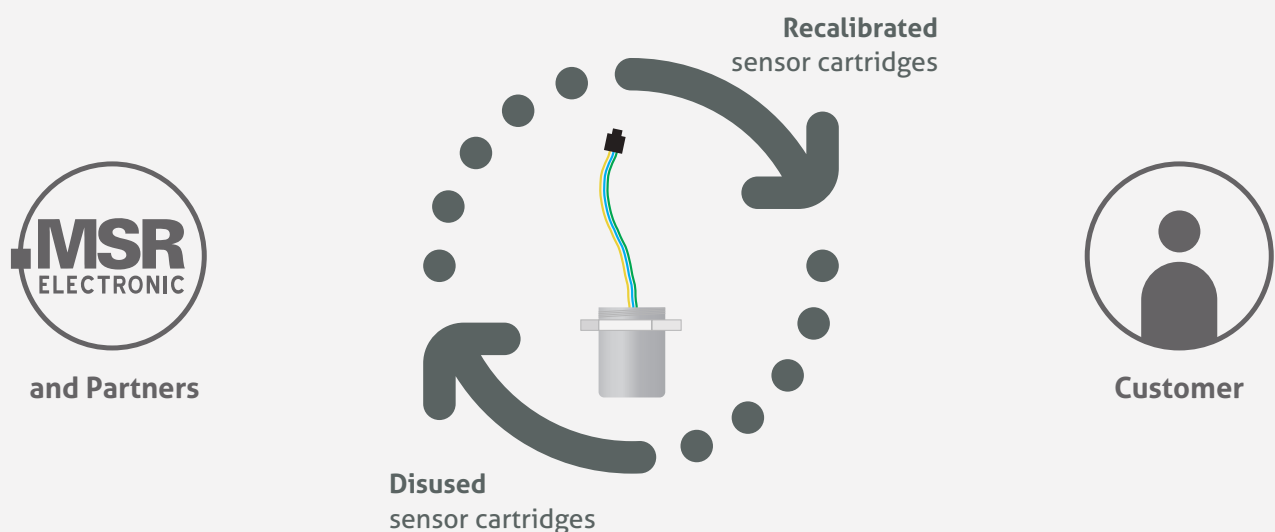

HOW-TO VIDEO

Watch the easy exchange process in this video



Quick and safe sensor exchange



Open the housing with a customary screw driver.



Disconnect the sensor cable and unscrew the disused sensor cartridge. **The yellow LED lights up.**



Replace the sensor cartridge and connect the cable of the newly calibrated cartridge to the board. **The yellow LED goes off again.**



Close the housing again and the recalibrated sensor is immediately ready for use.

Sensor-Board SB2

For connecting up to 3 different sensor cartridges

Sensor board with RS-485 interface.

Up to 3 different sensor heads of the SC2 line can be connected to the SB2 sensor board via the local bus. The SB2 ensures the power supply of the SC2 and provides the measured data of the sensor head for

digital communication. Communication with the DGC-06 controller takes place via RS-485 fieldbus interface with DGC-06 protocol. Additional protocols are available for direct connection to higher-level BMS.

+ BENEFITS

- Digital processing of measured values
- Internal function control with integrated hardware watchdog
- Measured values in sensor cartridge SC2, therefore easy change: uncalibrated <> calibrated
- Up to 3 different sensor cartridges
- Sensor cartridge can be mounted via remote board (RB2)
- Software according to SIL2 compliant development process
- Modular technology (pluggable and changeable)





Housing IP65

Interface Service Tool STL06
Control LED (green / yellow)

DGC-06 Fieldbus power supply

Input sensor head

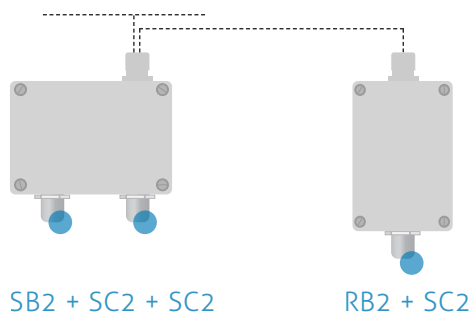

For the connection of up to 3 different
sensor heads



MSRSHOP24

Configure your product here: www.msr-24.com

Warning + Sensor-Board WSB2

With RS-485 interface, 4-20 mA output and alarm relay

Simple sensor exchange by plug connection on the local bus.

The warning and sensor-board WSB2 ensures the power supply of the sensors and processes the measured data of the sensor cartridge (SC) for digital communication. Communication with the DGC-06 controller takes place via the RS-485 fieldbus interface with DGC-06 protocol.

The SC is connected to the local bus via a plug connection. This allows a simple SC change instead of an on-site calibration. The internal X-Change routine recognizes the exchanged SC during the change process and starts the measuring operation automatically.

+ BENEFITS

- Digital processing of measured values incl. temperature compensation
- Internal function monitoring with integrated hardware watchdog
- Up to 3 different sensor cartridges (2 identical SC2 possible)
- Analog input, 4-20 mA for an analog sensor
- Software according to SIL2 compliant development process
- Modular technology (pluggable and exchangeable), IP65 design
- Easy maintenance and calibration by replacing the sensor cartridge or by convenient on-site calibration
- Serial RS-485 interface with protocol for DGC-06 (optional Modbus)
- 4-20 mA analog output
- 1 alarm relay with changeover contact, potential-free max. 30 V AC/DC, 0.5 A
- 1 fault signal relay, additionally configurable as alarm relay, with changeover contact, potential-free max. 40 V AC/DC, 0.5 A
- Display (optional)

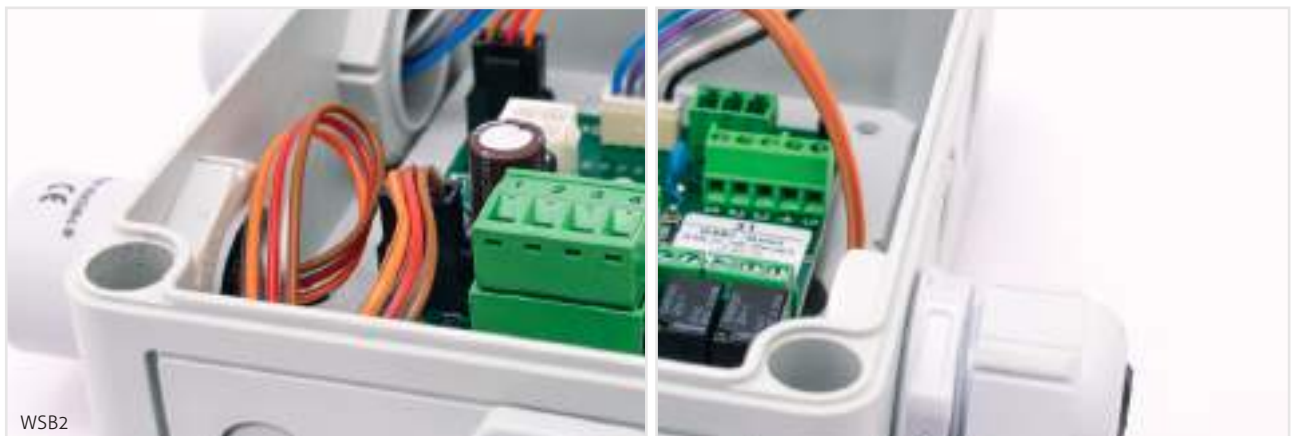



HOW-TO VIDEO

Take a look at the commissioning of the WSB2 in this video

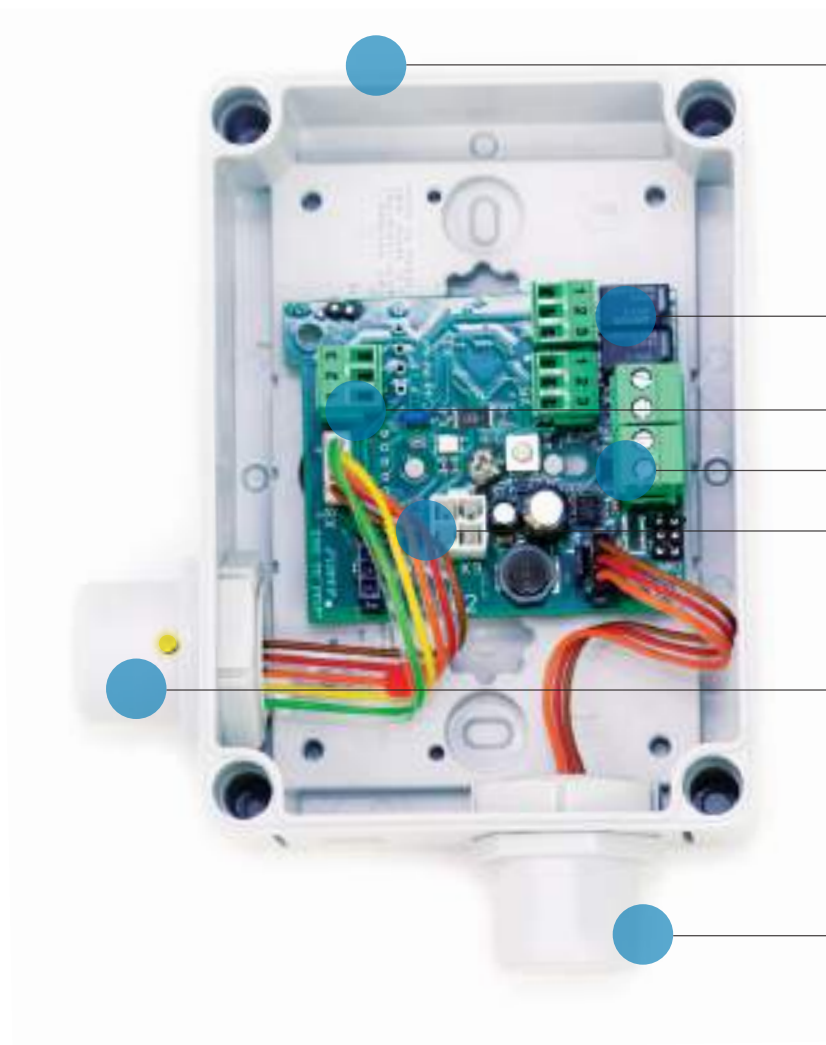

Housing IP65

Relay 40 V AC/DC, 0.5 A

Analog input 4-20 mA

Power supply

Interface Service Tool STL06

WAO: Status-LED with warning buzzer

Exchangeable sensor cartridge (X-Change)



MSRSHOP24

Configure your product here: www.msr-24.com

Multi-Sensor-Board MSB2

Flexible for several gases

Sensor board for integration of the sensor cartridge SC2 with relay.

The multi sensor board MSB2 is designed to accommodate up to 3 sensors. It provides 3 relays next to the sensor holder, which can be controlled by 1 higher-level controller, such as the DGC-06. The relay distribution on site

saves the wiring of warning devices or fans directly to the main controller. This allows a wide range of applications even with existing wiring.

+ BENEFITS

- Digital processing of measured values
- Up to 3 different sensor cartridges
- Software according to SIL2 compliant development process
- Modular technology (pluggable and exchangeable)
- Serial RS-485 interface with protocol for DGC-06 (optional Modbus)
- 3 relays (230 V / 5 A)
- Optionally also available with display (built-in or remote)
- Direct control of the warning devices by DGC-06 possible, thus considerable savings in wiring
- Also available as version with extended safety for wire break and function monitoring

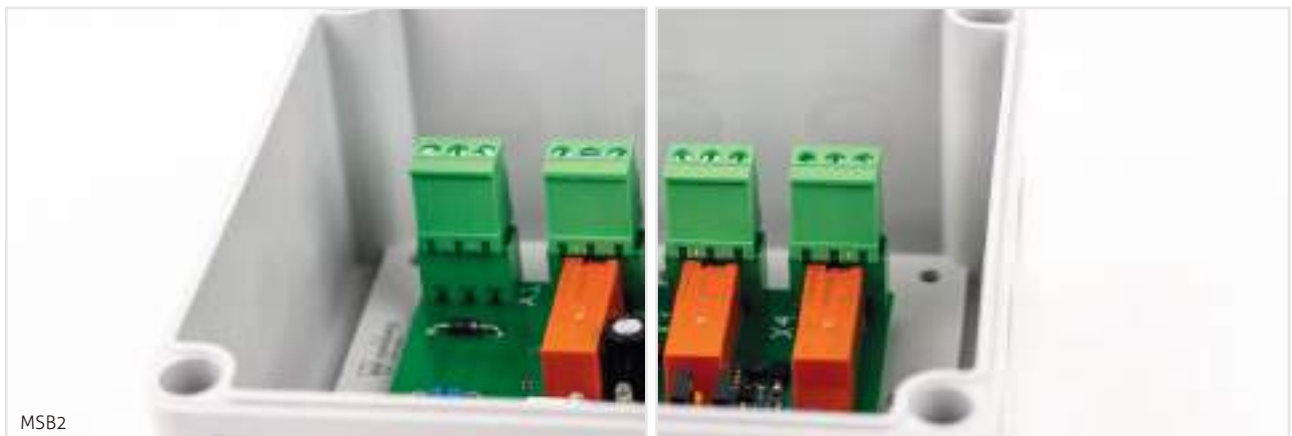



Housing IP65

3 relays 230 V / 5 A

Interface Service Tool STL06

Digital output 2x DC

Power supply

Analog input 4-20 mA



MSRSHOP24

Configure your product here: www.msr-24.com

Analog-Relay-Board ARB2

Monitoring and warning of gases

Gas measurement, warning and control board based on the latest technology for continuous monitoring of the ambient air.

The ARB2 is designed to connect one analog 4-20 mA sensor, e.g. MC2 sensor. The board monitors the measured value and activates the alarm relays when the set alarm thresholds for pre and main alarm are exceeded. In addition,

the measured value is provided as 4-20 mA at the analog output. Options such as display and warning unit (WAO) ensure adaptation to the wide range of applications in the gas measurement technology.

+ BENEFITS

- Easy maintenance and calibration by exchanging the MC2 sensors or comfortable on-site calibration
- Sensor can be placed up to 500 m
- Reverse polarity protected, overload and short circuit proof
- 1 analog input 4-20 mA, e.g. MC2 line and 1 analog output 4-20 mA / 2-10 V
- 2 relays with changeover contact, potential-free, max. 250 V AC, 5 A
- Various housing types with protection class IP65
- Display / WAO: Status-LED with warning buzzer (optional)
- Operating voltage 24 V AC/DC
- 100-240 V AC (optional)
- 12 V DC (optional)



ARB2, optional with sensor



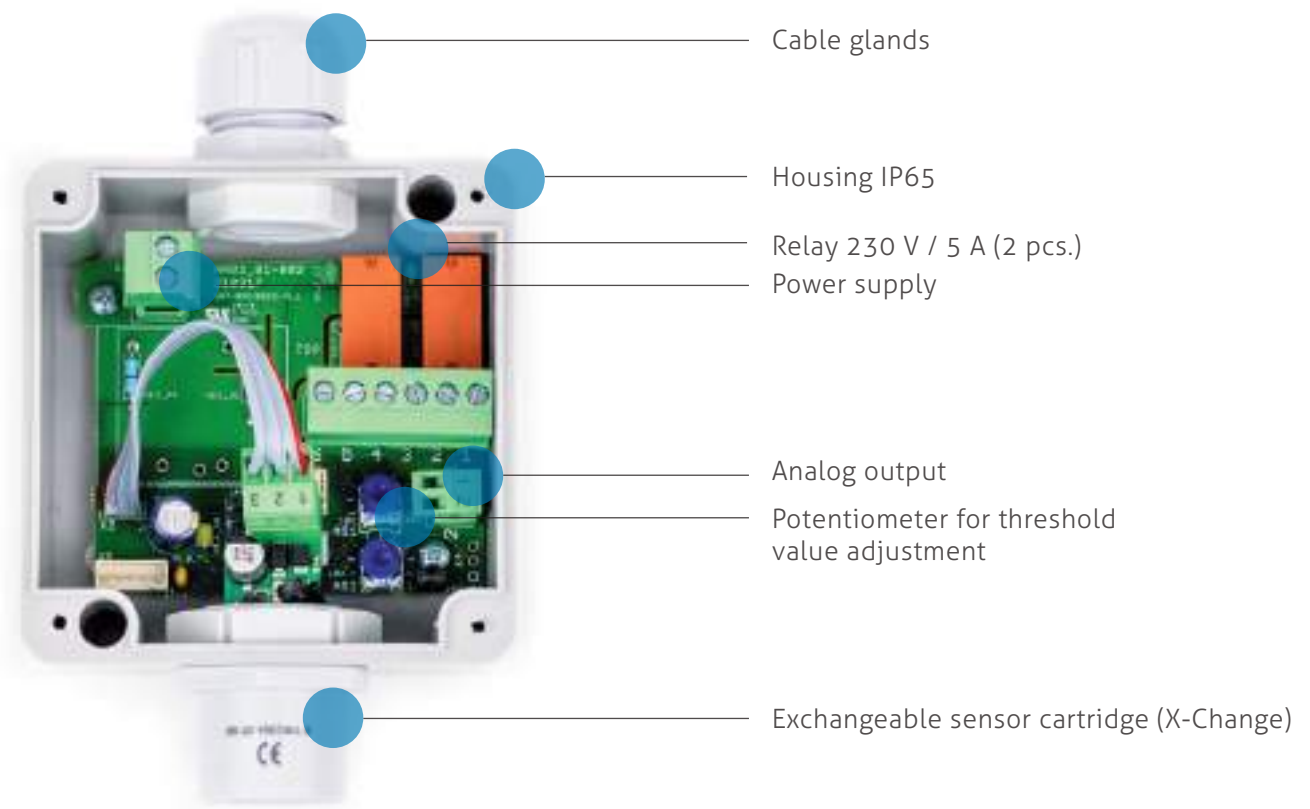

Cable glands

Housing IP65

Relay 230 V / 5 A (2 pcs.)

Power supply

Analog output

Potentiometer for threshold value adjustment

Exchangeable sensor cartridge (X-Change)



MSRSHOP24

Configure your product here: www.msr-24.com

Multi-Sensor-Controller MSC2

Different sensors for different gases

Modern multi sensor controller MSC2 for toxic and combustible gases.

The MSC2 multi sensor controller monitors the measured values and activates the alarm relays when the pre and main alarm thresholds are exceeded. Various output and input options allow easy integration into existing systems. The sensors are connected to the MSC2 directly

on the board. Up to 2 (different) digital sensors can be connected or 2 analog sensors can be connected remotely. In total the MSC2 can process up to 3 sensors. The MSC2 is therefore a small, compact version with many possible applications.



BENEFITS

- Hardware and software according to SIL-compliant development process
- Easy maintenance by replacing the sensor cartridge or convenient on-site calibration
- Modular technology (pluggable and exchangeable)
- Reverse polarity protected, overload and short circuit proof
- Local bus connection for 2 sensor heads SC2 + 2 analog inputs 4-20 mA (max. 3 sensors)
- 3 relays with changeover contact, potential-free max. 240 V AC, 5 A
- 2 transistor outputs, 24 V DC, 0.1 A (positive switching)
- Serial RS-485 interface with protocol for DGC-06 or Modbus protocol
- Different housing types with IP65
- 2 digital inputs
- Operating voltage 230 V AC, with wide range input 100-240 V AC (optional)
- WAO: Status LED with warning buzzer / acknowledgement button (optional)
- Display / UPS (optional)



MSC2 with display





HOW-TO VIDEO

Take a look at the commissioning of the MSC2 in this video

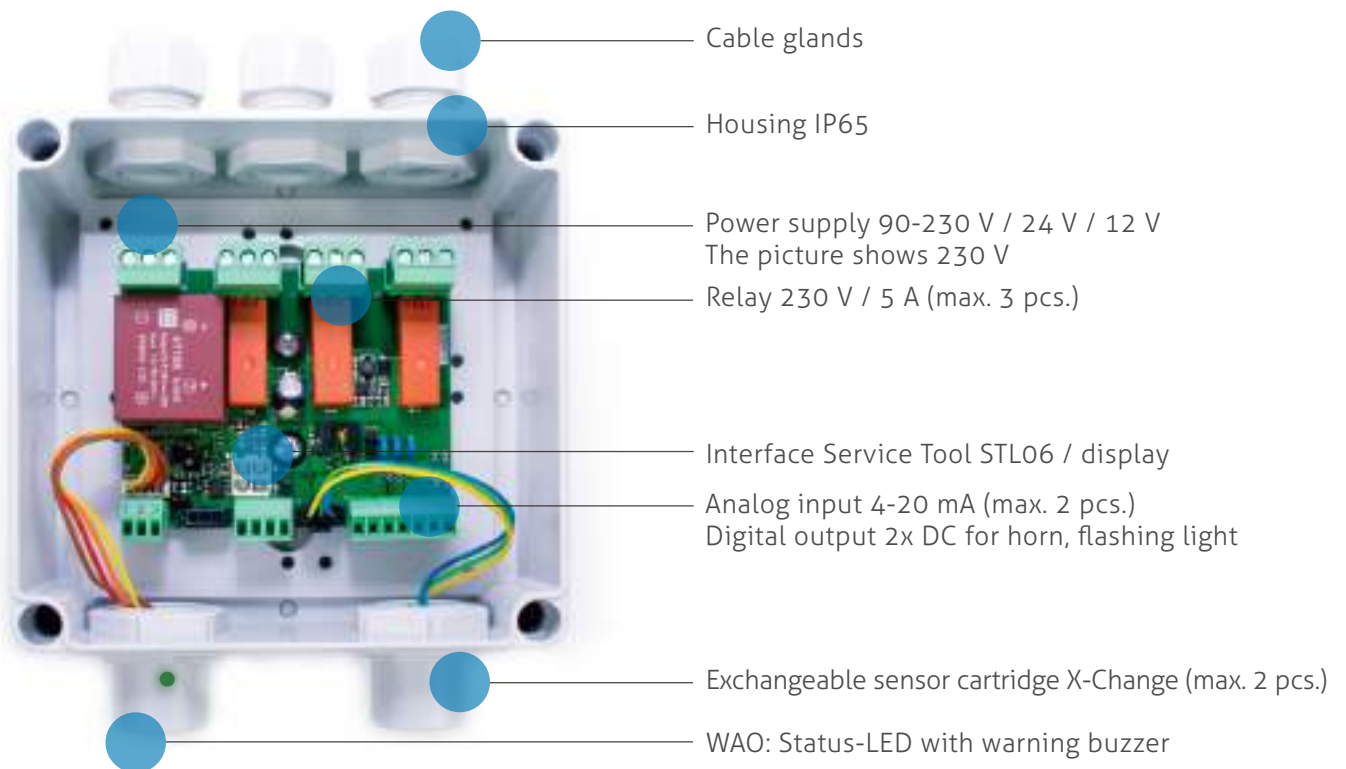

MSRS24

Configure your product here: www.msr-24.com

Compactcontroller

Versatile and flexible in use

The Compactcontroller is designed to connect up to 10 SB2Units via the local bus.

The controller monitors the measured values and activates the alarm relays when the pre and main alarm thresholds are exceeded. The measured values are provided via an RS-485 interface for direct connection to higher-level BMS and as a 4-20 mA output. The SIL2-compliant self-monitoring in the Compactcontroller as well as in the connected SB2Unit activates the fault message in case of

an internal fault in the same way as a fault in the local bus communication (SB2Unit). Further options such as WAO (status LED and warning buzzer) and digital input for the acknowledgment function ensure adaptation to the wide range of applications in gas measurement technology. The Compactcontroller can be configured and parameterized completely without an additional hand tool.



BENEFITS

- Display for all notification, configuration and calibration functions (no tool necessary)
- Fieldbus connection for up to 10 gas sensors (SB2Units) with max. 900 m length
- Hardware and software according to SIL-compliant development process
- Modular technology (pluggable and exchangeable), reverse polarity and overload protected
- Internal function monitoring with integrated hardware watchdog
- 3 relays, 2 transistor outputs, 2 digital inputs
- Different housing types with IP65
- WAO: Status-LED with warning buzzer (optional)
- Operating voltage 230 V AC, with wide range input 100-240 V AC (optional)
- UPS (optional)



Compact gas warning system for up to 10 sensors

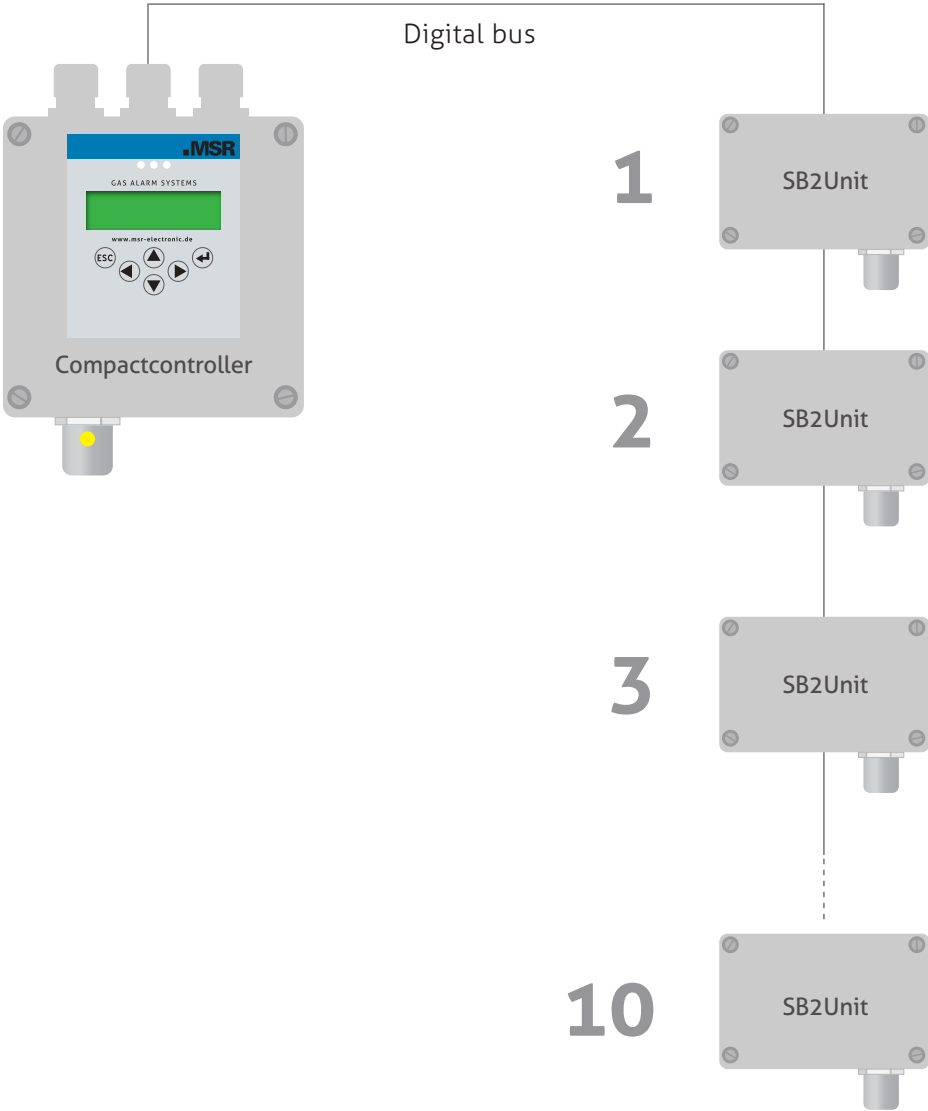

MSRSHOP24
Configure your product here: www.msr-24.com

Multi-Gas-Controller MGC2

Versatile and flexible in use

Multi gas controller for toxic and combustible gases, refrigerants and oxygen.

The multi gas controller MGC2 monitors the measured values and activates the alarm relays when the pre and main alarm thresholds are exceeded. Various output and input options

allow easy integration into existing systems. Up to 3 analog sensors can be connected remotely to the MGC2. The MGC2 thus represents the compact version for analog sensors.



BENEFITS

- Internal function monitoring with integrated hardware watchdog
- Hardware and software according to SIL-compliant development process
- Easy maintenance by replacing the sensor cartridge or convenient on-site calibration
- Modular technology (pluggable and exchangeable)
- Reverse polarity protected, overload and short circuit proof
- Local bus connection for 2 sensor heads SC2 and 2 analog inputs 4-20 mA (max. 3 sensors)
- 3 relays with changeover contact, potential-free max. 240 V AC, 5 A
- 2 transistor outputs, 24 V DC, 0.1 A (positive switching)
- Serial RS-485 interface with protocol for DGC-06 or Modbus protocol
- Different housing types with IP65
- 2 digital inputs
- WAO (status LED with warning buzzer) for warning, fault, operation and service (optional)
- Acknowledgement button (optional)
- Operating voltage 230 V AC, with wide range input 100 to 240 V AC (optional)
- Display / USV (optional)



MGC2 with display



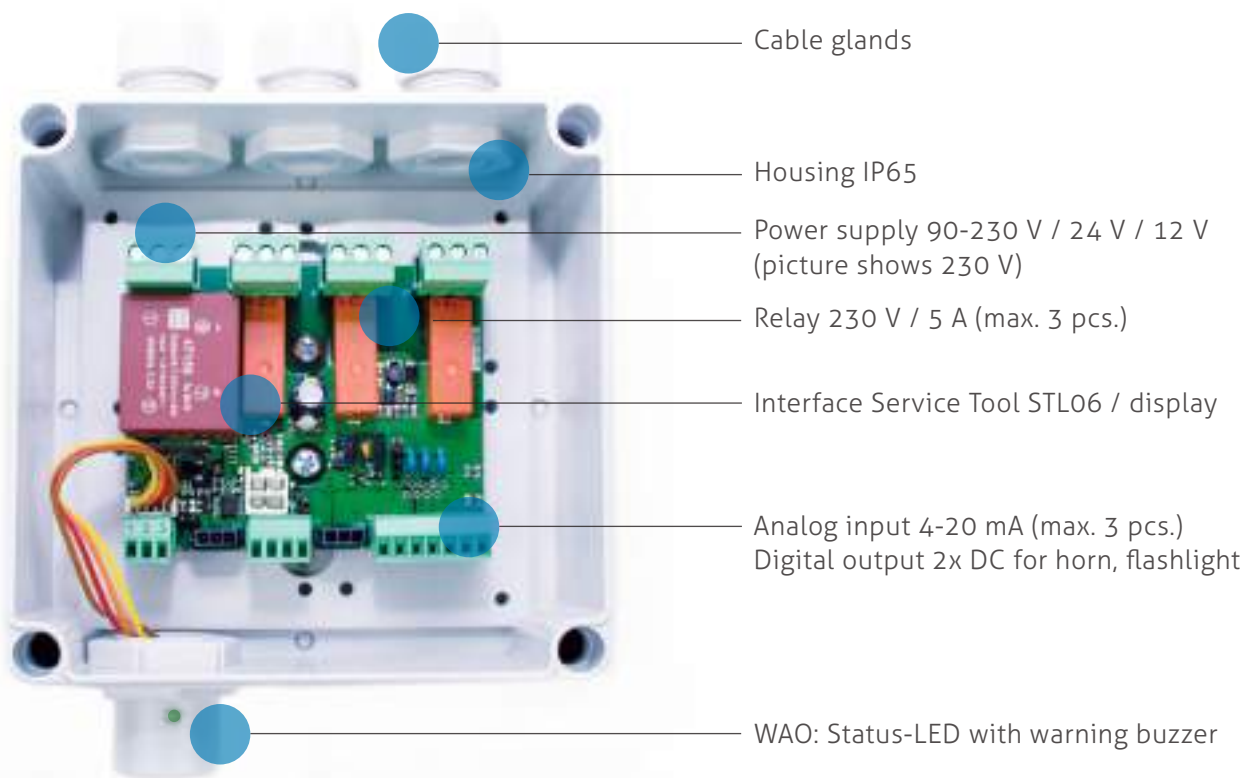

MSRSHOP24

Configure your product here: www.msr-24.com

Add-on: Gas Selector for MSC2

Free rein for detection

The Gas selector for various gas combinations.

With the gas selector you have a simple and quick selection of the gases to be individually detected. No further tool is necessary. This makes quick configuration and adjustment easy with the gas selector. Incorrectly connected or reversed SC2 sensor cartridges are immediately detected as an error.

Two different measuring heads can be operated on the device. The gases from different Freon groups or CO₂ can each be used in parallel on the device. The advantage is fast operational readiness of the devices including adaptation to different gas types.

+ BENEFITS

- Basic product: MSC2
- No additional tool required
- Universally applicable
- High number of available gas combinations
- Cost and time saving



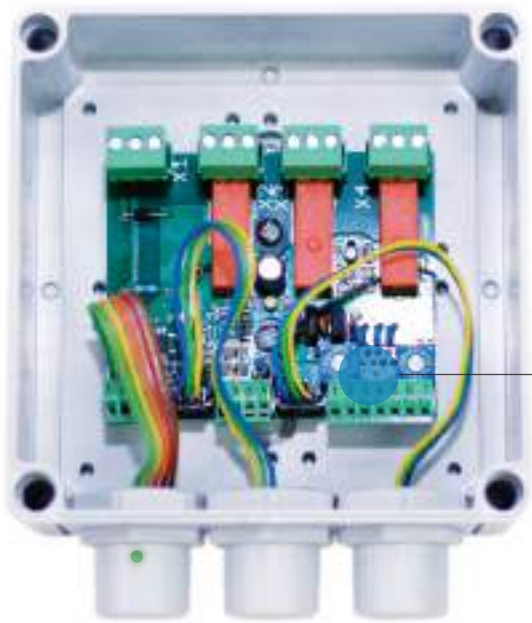

Gas selector

SETTING OPTIONS

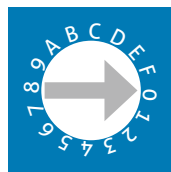

Zero position:

No gas selected
(factory setting)



Gas selection, for example:

Position 1: CO₂ (R744)
Position 2: R134a



MSRSHOP24

Configure your product here: www.msr-24.com

Digital-Gas-Controller DGC-06

The gas monitoring center

Measuring, warning and controller system for toxic and combustible gases in garages.

The digital gas controller DGC-06 has been developed for large systems or even for extensive connections. There will hardly be a scenario in gas monitoring which this controller does not cover. From complex garages to access functions switched by gas alarm, everything is possible. The innovative DGC-06 gas controller line is designed accor-

ding to EN 50545 and can monitor and evaluate up to 128 gas sensors, 96 digital and/or 32 analog sensors (4-20 mA). There are 4 freely adjustable alarm thresholds per sensor. For alarm messages, the controller system has up to 128 relays with potential-free changeover contact and up to 16 analog outputs with 4-20 mA signal.



BENEFITS:

- 128 sensors
- Relay extendable with EP modules
- Display with LED
- Service tool for configuration
- Direct connection to GLT, GC-06 integrated
- Units are adjustable
- UPS / data logger (optional)
- Can be integrated into switch cabinet
- Safety product, scalable
- Expandable for up to 7 EP-06 modules



DGC-06 display





MSRSHOP24

Configure your product here: www.msr-24.com

Modules

Perfect control of the actuators

Measuring, warning and controlling system for toxic and combustible gases and vapors.

The modules are designed according to EN 50545 and can be assembled for any situation by means of a simple configuration. The controllers, such as the GC-06, are the core elements of the systems. Expansion modules, like the EP-06, provide additional inputs and outputs. Since MSR-Electronic has extensive cer-

tification and many years of experience in the manufacture of controllers, professional preparation for complex acceptance tests is guaranteed. The modular technology allows for compact yet flexible and highly efficient systems.



BENEFITS

- Modular assembly
- Individual configuration
- Various options
- Serial bus



MSRSHOP24

Configure your product here: www.msr-24.com



Module GC-06



Module GC-06

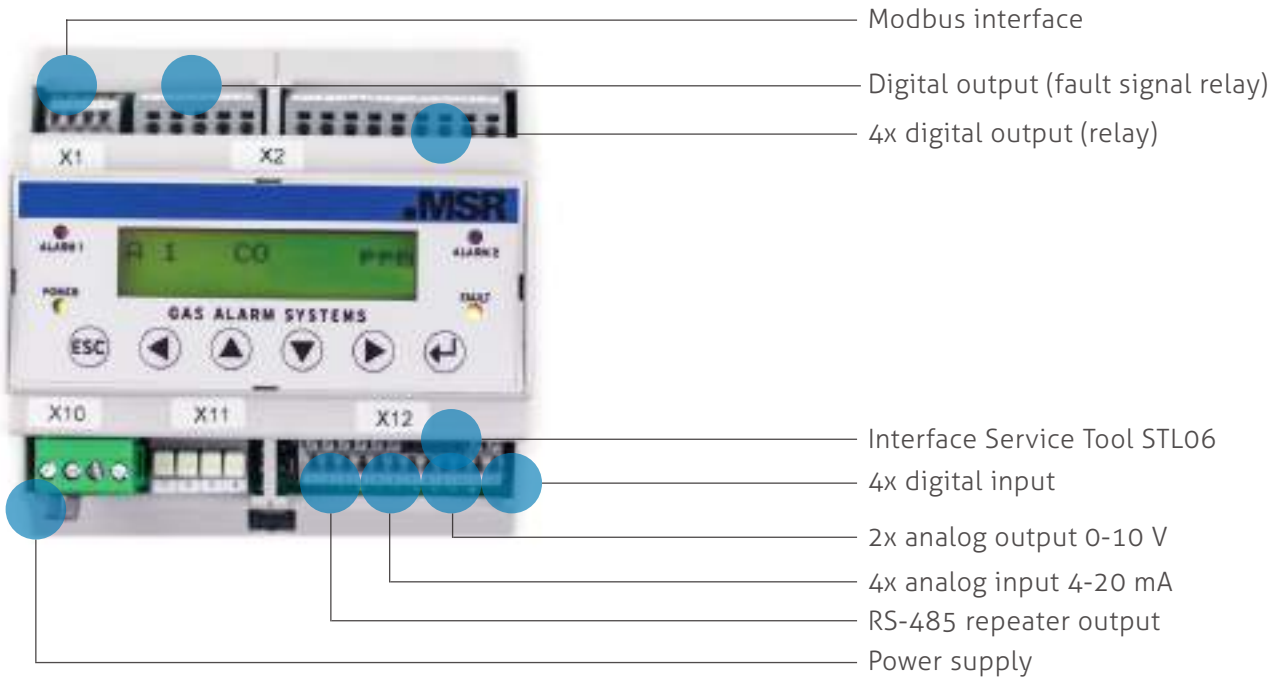

Expansion module EP-06 für GC-06

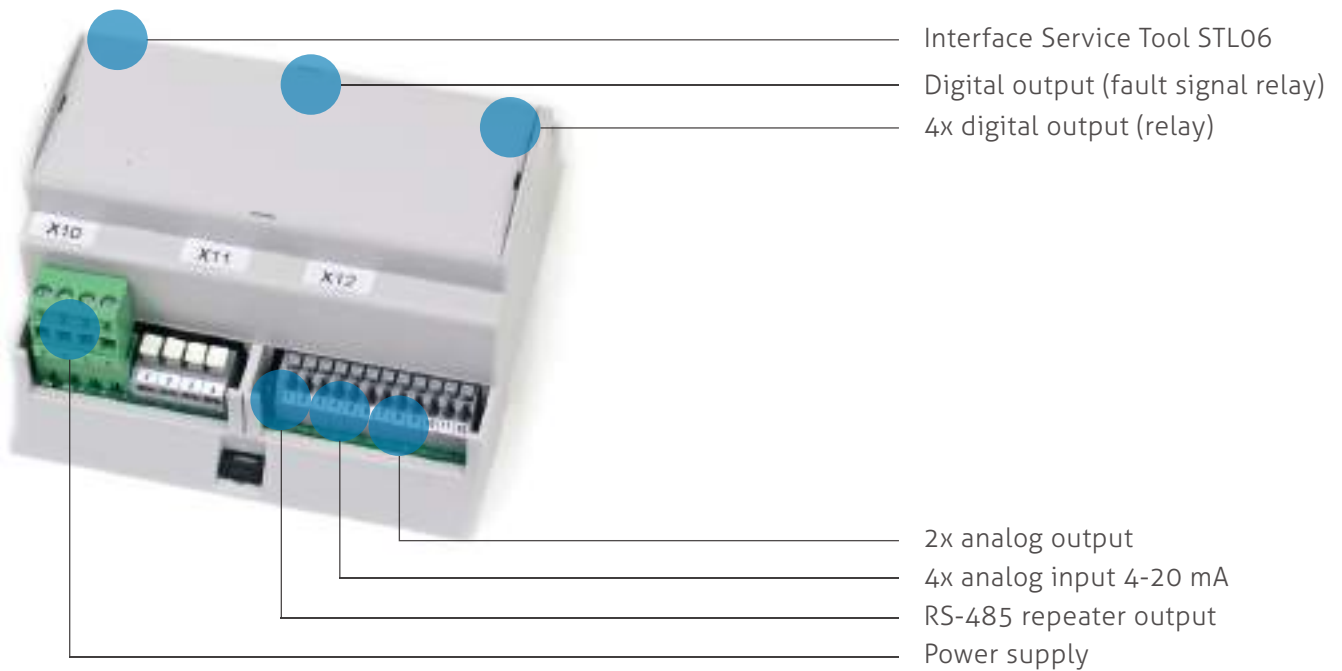

Door-Entrance-Module DEM-06

Safe access monitoring

The DEM-06 module visualizes the gas alarm in real-time at all access points.

The DEM-06 door entrance modules from MSR-Electronic ensure maximum safety. If an increased gas concentration occurs in buildings, e.g. in parking garages, the entrances and

entries can only be opened in one direction: From the inside to the outside. This ensures that persons can only move outwards from the hazardous area, but never inwards.



BENEFITS

- Optical and acoustic warning
- For buildings with different danger zones
- Stand-alone application (without DGC controller) possible
- No intervention in the DGC controller system necessary
- Configurable for up to 96 sensors in one DGC controller system
- Cost saving



MSRSHOP24

Configure your product here: www.msr-24.com



DEM-06



Access monitoring parking garage

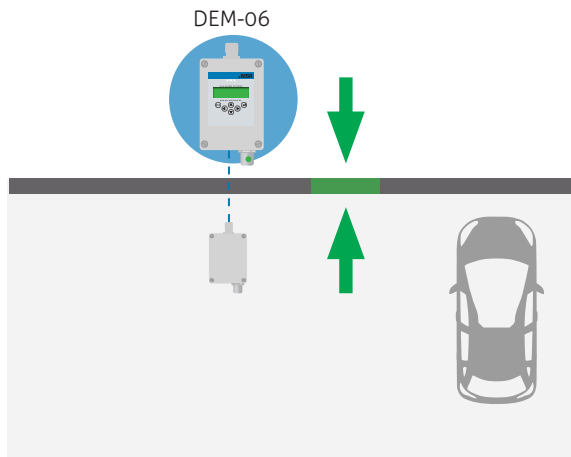

No gas alarm: Display green

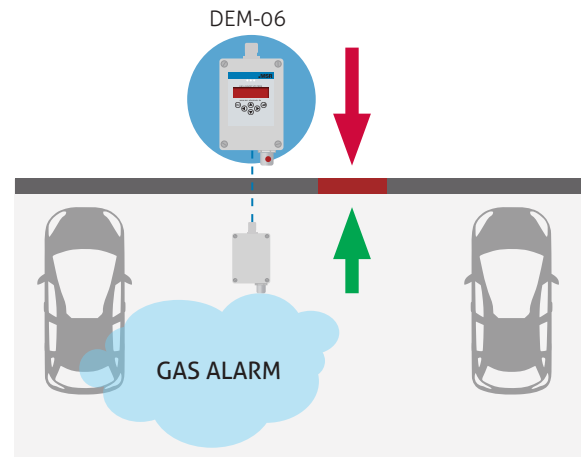

For gas alarm: Display red

Access monitoring large capacity laboratory

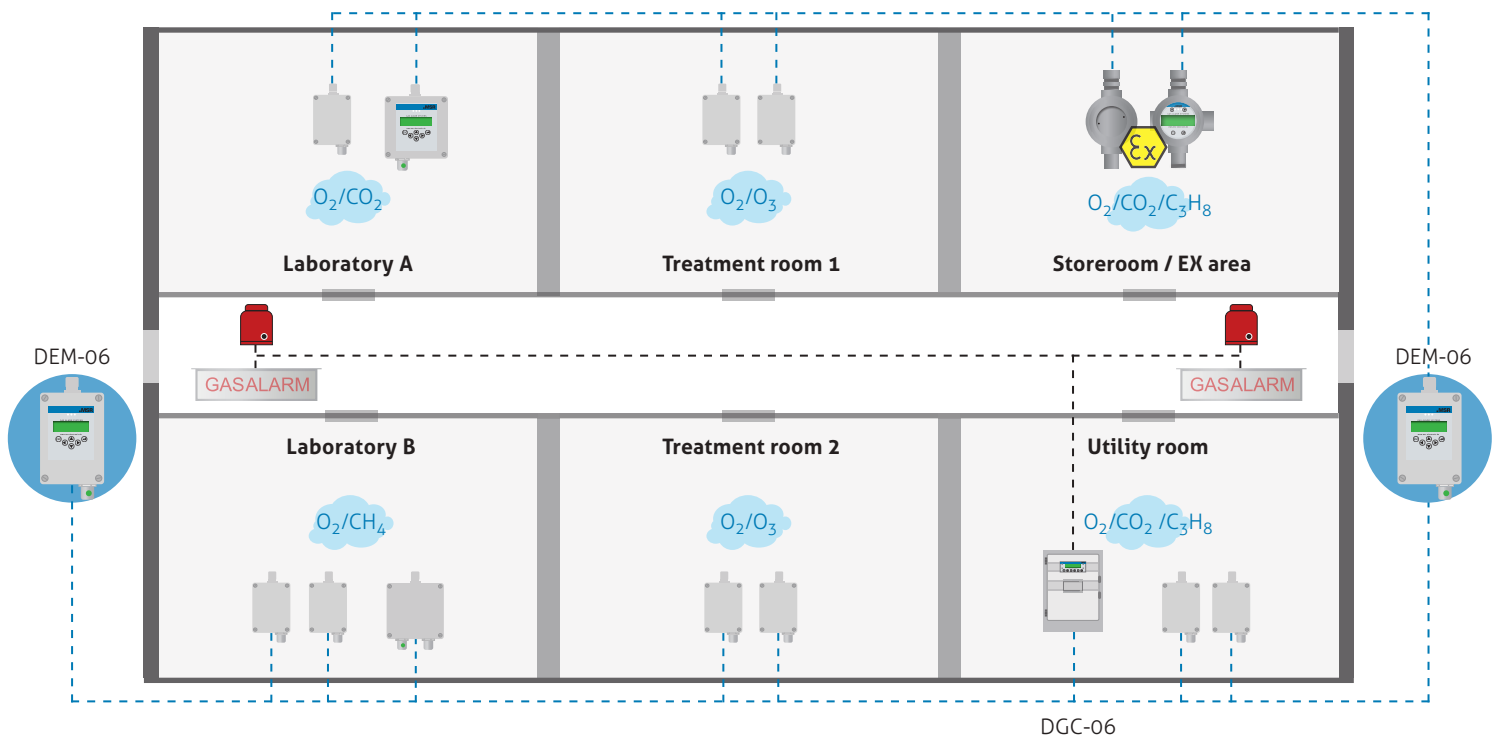

DGC-06

Software PCE06

Perfect for gas warning system service

Self-supporting, menu-driven PC tool for convenient addressing, parameter setting and calibration for devices for the PolyXeta®2, PolyGard®2 and µGard® product line.

The communication to the PC is done via the supplied USB-RS-485 and USB/TTL adapter. The supply and data coupling with galvanic isolation to the devices is carried out via a cable with plug connection.

+ BENEFITS

- User-friendly design
- No installation required on the PC
- Available for operating systems Windows 7, 8, 10
- Dongle protection in the adapter, thus PC change possible without problems (turn off virus scanner for USB required)
- Communication / power supply of the adapter via a cable
- Recording and export of measured values possible
- Now available as offline version: Easy configuration and quick loading into the controller on site

Screenshots of the software PCE06Seite

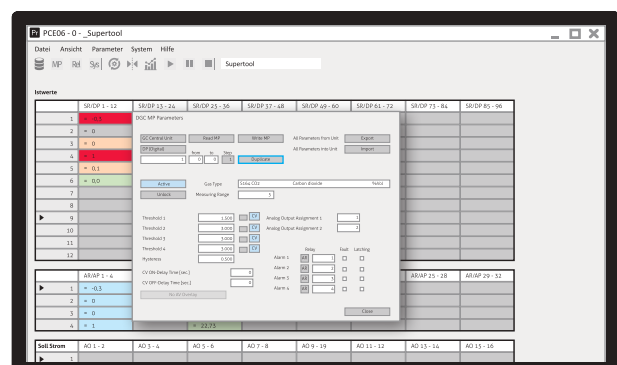
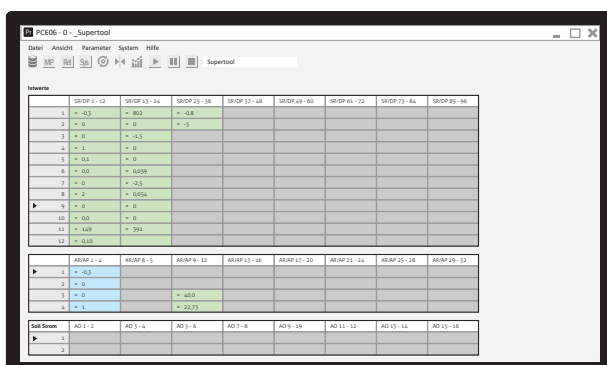

Service-Tool STL06

In user-friendly design

Self-supporting, menu-driven tool for convenient addressing, parameter setting and calibration for devices for the PolyXeta®2, PolyGard®2 und µGard®2 product line.

The communication and power supply are done via a cable which is connected to the respective devices.

+ BENEFITS

- User-friendly design
- Simple menu structure
- Two-line display / 16 characters
- 6 operating keys
- 3 LEDs for status display
- Communication / power supply via a cable



MSRSHOP24

Configure your product here: www.msr-24.com



STL06



Warning Devices

Always on alert

Robust, maintenance-free and energy-saving LED technology for static or flashing control.

Warning sign

Due to the flat design in the solid aluminum profile and the low weight, a simple one-man assembly is possible. The electrical connection is carried out in the supplied WT-box without opening the warning sign. It serves as optical warning of a dangerous gas concentration or a malfunction of the ventilation system in underground car parks, tunnels, car workshops, loading zones as well as in all areas where optical warning of a dangerous gas concentration or other hazards is necessary.

Flashing light

The Xenon flashing light is made of solid plastic (ABS) according to EN 50545. It is universally applicable for fire alarm and safety technology according to VdS guidelines.

Warning horn

The warning horns consist of solid housings, e.g. plastic (ABS) according to EN 50545. It is universally applicable with 32 adjustable tones, incl. DIN tone for fire alarm and safety technology in accordance with VdS guidelines.

Warning horn/flashing light combination

The warning horn incl. flashing light made of solid plastic (ABS), according to EN 50545, is universally applicable. It consists of the warning siren and a xenon flashing light for acoustic and optical warning with separate control.



Warning sign



Warning horn/flashing light combination



Standard versions warning signs

Version D3, 642 x 203 x 22 mm

Two-sided: Text red, background white

Version D3, 642 x 203 x 22 mm

Two-sided: Text yellow, background white



For wire break and function monitoring available as version with extended safety (ES)

Visibility information

According to the requirements for escape sign luminaires in accordance with DIN 4844, where applicable, there is a visual range of 26.4 m for backlit signs with a sign height of 132 mm and an average luminance of 200 cd / m. The material is not translucent and therefore easy to read even in bright light.



MSRSHOP24

Configure your product here: www.msr-24.com

Additional Accessories

For sensor calibration and leakage protection

Air duct system

Duct mounting set with plastic housing



BENEFITS

- Flow velocity: min. 5 000 m/h, max. 20 000 m/h
- Duct diameter: Min. 0.1 m, max. 1.0 m
- Flammability: UL 94 V2
- Tube length: 2x 1 000 mm
- Sampling tube 250 mm adaptable to duct diameter

SplashGuard

A cover that protects a SC2 or MC2 from rain and splash water from all directions.

The splash protection cap is put on the sensor cartridge. Calibration can be performed with the mounted protective cover using a compatible calibration adapter.



BENEFITS

- Protection of SC2 and MC2 sensors against rain and splash water from all directions
- Protective cap is placed directly on the sensor cartridge
- Calibration with mounted protective cover by means of a compatible calibration adapter



SplashGuard



Calibration adapter

For convenient gassing of sensors of the SC2 and MC2 line and for the targeted supply of zero and test gases to the sensor cartridge.

The adapter is optimally designed to bring the gas directly to the respective sensor cartridge. This enables the most accurate calibration, which is absolutely necessary for proper function. The tube can be connected directly to the pressure limiter of the gas cylinder.



BENEFITS

- Suitable for all gases
- Easy to use
- Perfect coverage of the sensor cartridge



MSRSHOP24

Configure your product here: www.msr-24.com



Calibration adapter

Control Box

In combination with GC-06, DGC-06

Visualize measurement data and identify hazards at a glance.

The Control Box is used in combination with the gas controller GC-06 or DGC-06 (each with Modbus option) of a gas alarm system.

The display can show sensors, measured values and parameters such as alarm relay switching

thresholds. Statistics can also be queried and exported. Due to the integrated network interface, the Control Box can be integrated into an existing network and thus all measured values can be retrieved remotely.



BENEFITS

- Plug & play Software
- Automatic reading of the configuration and display of the AR/SR and the measured values
- Multiple user levels possible
- Display of current values, statistics, faults, alarms etc.
- Capacitive multi-touch screen
- Easy mounting
- Subsequent installation possible
- Network interface for integration into existing network
- Access with mobile devices and PCs via web browser



Control Box





MSRSHOP24

Configure your product here: www.msr-24.com

MSR-Cloud

Everything at a glance via PC, smartphone or tablet

Thanks to plug and play visualization, the innovative cloud solution works simply and easily, even with systems that have already been installed.

A graphical trend monitoring can be accessed via the MSR-Cloud. The intuitively designed rights management of access to the systems deserves special mention. This allows complete control over the systems, and this via worldwide access via the Internet. Not only visualizations can be displayed via the cloud. A complete overview of alarms, errors and other notifications is also

possible. These can be routed via mail or SMS. In addition, links to data sheets, operating instructions or individual files are provided. This considerably simplifies the workflow for service staff. As a planning tool, the cloud is also an ideal partner for receiving information on upcoming maintenance and service activities early on.

+ BENEFITS

- Fully customizable information
- Adjustable notifications
- Clearly arranged dashboard
- Hosting with MSR-Electronic possible
- Real-time information such as warning and maintenance messages
- Configurable structure of rights
- Multiple projects in one cloud solution
- Access via web browser or with mobile devices (cell phone, tablet, ...)
- For all devices that have a compatible browser and access to the Internet



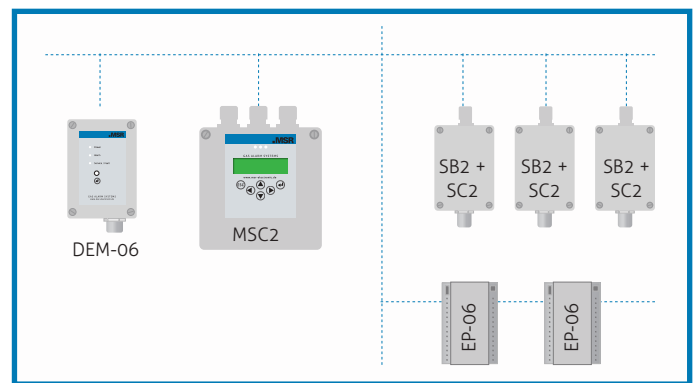

PROJECT ADMINISTRATION

- Overview and administration of projects and user rights
- Create your own symbols and icons
- Individual notifications configurable

Extended Safety (ES)

Certified monitoring system in garages and tunnels

Certified monitoring system according to SIL for ventilation and smoke extraction.

The gases CO, NO and NO₂ to be monitored by sensors are defined in EN 50545 as a central element of gas monitoring. In addition to the type of warning message, SIL monitoring is also required to comply with EN 50271, which is referred to in EN 50545.

With its MSB2-ES, MSR-Electronic has developed a module that monitors the warning devices used for functionality and wire breakage, even when they are switched off, and sounds an alarm immediately if one should fail. The module is also connected to the safe SIL2 bus in the system.

MSR-Electronic goes one step further with special motor control modules that feature safe SIL communication, standardized and easy to set up. The modules only need to be parameterized via a predefined matrix in the central unit (Motor-Control-Module) and can thus be adapted to any

type of motor. By standardizing the modules, it is thus possible to achieve a high level of savings in the wiring in the control cabinet, resulting in considerable cost savings.

The fire alarms can be switched collectively to a fire alarm module (Fire-Detection-Module) or directly to the motor modules. This increases the flexibility of the system design within a safe framework.

To make the integration of the system perfect, the fire department panel for direct control of the ventilation system by the fire department with the tableau module (Fire-Control-Module) can also be integrated into the safe system. Here too, the forwarding is carried out via SIL-certified communication and is therefore safe and reliable.



Risks in the parking garage

- Time consuming and complex planning due to undefined specifications
- No functionality according to SIL
- Increased costs for planning, manufacturing, services and life cycle

Solutions from MSR-Electronic

- A certified system provider for gas warning and ventilation control according to SIL
- Lowest error rate according to SIL2
- Optimized planning costs as well as lower manufacturing and life cycle costs



PDF DOWNLOAD

See the complete brochure for safe parking garages here. We would also be glad to send it to you by mail (just send an email to info@msr-electronic.de.)

The Central Module

GC-06-ES

Measuring, warning and controlling system for toxic, combustible gases and vapors.

- +** **Benefits Gas Warning Module**
 - Can monitor and evaluate up to 100 sensors, 96 of which are digital and/or 4 analog (4-20 mA) sensors
 - A separate relay is integrated for fault message
 - Integrated overload and polarity protection
 - Simple and convenient commissioning
 - 4 alarm relays with potential-free changeover contact and 2 with analog outputs (4-20 mA) for connection to the gas controller GC-06
 - ES version for use in combination with the motor management
 - VDI 2053 / EN 50545 certified

- +** **Benefits Ventilation**
 - Control per drive: OFF/ON or OFF - stage 1 - stage 2, fire and reverse operation
 - Control of up to 7 zones
 - Direct connection to the motor modules via sensor bus
 - Connection of fire alarm system/fire detector
 - Connection of fire department tableau
 - Easy parameterization



The System Module

EP-06-ES-MCM

- + Benefits System Module**
 - Up to 128 MOT motor modules with max. 14 zones
 - Control per drive: OFF/ON or OFF - stage 1 - stage 2, fire and reverse operation
 - Integrated gas/fan control (free matrix)
 - Total current measurement of the fans per zone
 - Energy Management
 - Easy to integrate into the gas alarm management system and highly user-friendly
 - Option: Display DEM-06-ES for monitoring the motor states (up to 128 states)
 - Easy parameterization
 - Detects all deviations
 - Management of up to 128 modules in complex systems
 - More cost-effective maintenance due to automatic test cycles of all devices

- + Benefits Fire Alarm System**
 - Processing of fire alarm signals and scenarios
 - Safe SIL bus

- + Benefits Fire Department Tableau**
 - Direct processing of fire department tableau signals
 - Safe SIL bus



The Motor-Module

EP-06-ES-MOT



Benefits Motor-Module

- Control of two 2-stage, four 1-stage or from one to four continuously variable motors
- Stand-alone or in an ES system network
- Fire alarm activation, SIL communication
- Modular function, standardized
- Applicable for all common motor variants
 - Star/triangle
 - Dahlander
 - Separate winding
 - Frequency converter/EC
 - Soft starter
 - Reversible
- Up to 128 MOT motor modules with max. 14 zones



Benefits GC Module / Stand-alone

- Control of two 2-stage, four 1-stage or from one to four continuously variable motors
- Up to 7 zones directly on the bus (with several modules)
- Forwarding to motor duplication
- Fire alarm activation, SIL communication
- Modular function, standardized



The Fire-Control-Module

EP-06-ES-FCM



Benefits Fire-Control-Module

- Operation in the ES system network
- Control and monitoring of operating devices
- Safety-oriented control
- Fire alarm system input for fan / motor management
- Smoke extraction on/off input (request fire department tableau)
- Processing of automatic on-off switches per zone
- Processing of 3 pieces of message green / yellow / red
- 24 V DC operating voltage
- Serial RS-485 interface with protocol for ES system
- Connection socket for service tool
- 1 relay output max. 250 V/3 A (changeover contact) potential-free (fault signal)
- Soft- and hardware according to SIL-compliant development process
- Internal function monitoring with integrated hardware watchdog
- Digital and safe SIL communication



The Warning-Device-Module

MSB2-ES



Benefits Warning-Device-Module

- Internal function monitoring with integrated hardware watchdog
- Software and hardware according to SIL compliant development process
- Modular technology (pluggable and exchangeable)
- Serial RS-485 interface (SIL) with protocol for DGC-06-ES
- Analog output (4-20 mA) with selective signal output for special status, fault, etc.
- 1 digital input
- 2 alarm relays with change-over contact, potential-free max. 240 V AC, 5 A, control locally or via DGC-06-ES
- Fault signal relay with changeover contact, potential-free max. 240 V AC, 5 A, also configurable as alarm relay
- Monitoring of the connected type-tested warning devices for function and wire break with error detection < 1 min
- Connection socket for service tool

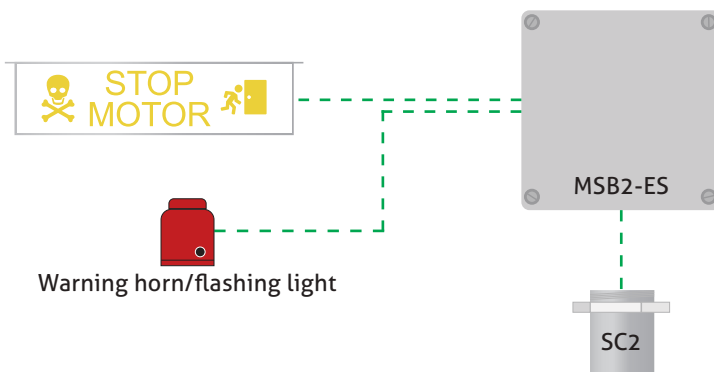

The Fire-Alarm-Module

EP-06-ES-FDM



Benefits Fire-Alarm-Module

- Operation in the ES system network
- 24 V DC operating voltage
- Serial RS-485 interface with protocol for ES system
- Connection socket for service tool
- 1 relay output max. 250 V/3 A (changeover contact) potential-free (fault signal)
- Soft- and hardware according to SIL-compliant development process
- Internal function monitoring with integrated hardware watchdog
- Connection of up to 8 fire zones
- Digital and secure SIL communication
- Collects fire alarms
- Flexible in use
- Can be used centrally in the switch cabinet or decentrally



Parking Guidance Systems

Indoor and Outdoor

Ultrasonic sensors are used to record the availability of each individual parking space and manage it using a controller/control computer.

The current occupancy status is shown on LED displays at the entrance and per level. In this way, customers can be guided directly to the nearest available parking space. This not only makes searching easier and reduces traffic in the parking garage or on the outside parking lot, but also saves the customer valuable time.

Thanks to the optimally used parking spaces, the operator can also reduce ventilation costs. The systems for recording and counting incoming and outgoing cars in multi-storey car parks can be implemented for one area or for individual levels.



BENEFITS

- Long service life
- No additional maintenance costs
- Exact recording and monitoring of all parking spaces
- Significant reduction of parking search traffic
- Minimal installation effort
- Optimization of parking space utilization
- Short payback time of the system
- Reduction of CO₂ emissions and reduction of ventilation costs
- Suitable for indoor use
- High detection accuracy
- Sensor and status display in one housing



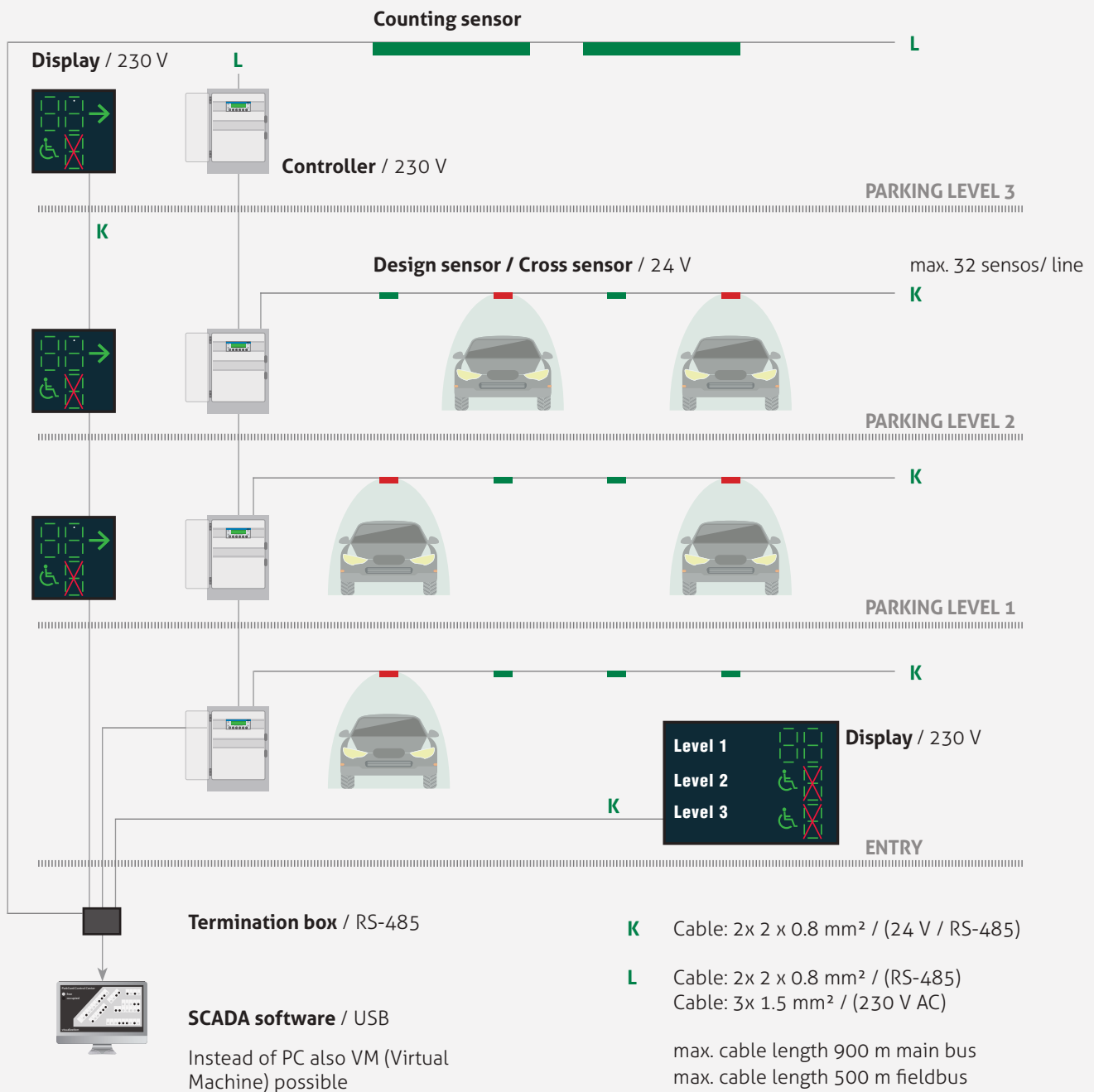

PDF DOWNLOAD MSR-Traffic Online Catalog

We would also be glad to send it to you by mail (just send an email to info@msr-traffic.de).

PolyXeta[®] 2

Gas warning systems for industrial plants

MSR-Electronic protects health and equipment under extreme industrial conditions. In the chemical and petrochemical industry, permanent monitoring of rooms and plants in which explosive atmospheres can form is required. The protection of persons requires constant monitoring of toxic and combustible gases and vapors. Furthermore, permanent monitoring for oxygen deficiency and excess must be

carried out. MSR-Electronic offers a wide range of methods for the permanent detection of gases. On this basis, MSR-Electronic develops individual gas sensors for industrial applications where extreme environmental conditions prevail. Safety, economic efficiency and competitiveness are the main priorities at MSR-Electronic.

+ BENEFITS

- **More safety**
More than all national standards require
- **Exchangeable sensor with X-Change technology**
Significantly lower maintenance costs
- **Accurate planning with overall lower costs**
- **Integration in BMS**
(e.g. Modbus)





.MSR
**SAFETY
FIRST**

Certificates and Approvals

Safety for all applications

The products of MSR-Electronic comply with more than the general standards and regulations and can therefore guarantee the safety of the system.

When handling hazardous substances, special safety precautions are mandatory. This is especially true in the chemical industry, where many different hazardous substances are used. MSR-Electronic provides innovative sensors and controllers to detect and immediately indicate life-threatening gases. The products, services and training courses are based on many years

of experience and were compiled with a lot of know-how and tailored to individual customer requirements.

The sensors from MSR-Electronic permanently monitor the ambient air for combustible and toxic gases as well as oxygen. Of course, also in Ex-Zones 1 and 2.



Industry: Approvals for PolyXeta®2

Electrical explosion protection of sensors and devices according to ATEX/IECEX, EN 60079-0/-1

(DEKRA Testing and Certification GmbH)

Device series types: PX2, SX1, SSAX1

Metrological testing of sensors and devices according to EN 60079-29-1 / EN 50104

(DEKRA Testing and Certification GmbH)

Device series types: PX2, SX1, SSAX1

Functional test (SIL2) of sensors and devices according to IEC / EN 61508-1 -2 -3, EN 50271

(DEKRA Testing and Certification GmbH)

Device series types: PX2, SX1, SSAX1

Other conformities: EU Directive 2014 / 34 /EU, 2014 / 30 / EU und 2014 /35 / EU,
EN 61010-1, EN 50270, EN 378, EN 50402, EN 14624, ISO 9001, EAC-Metrological approval

Device series types: PX2, SX1, SSAX1



Biogas Plants

Safe protection against CH_4 / H_2S / CO_2 / O_2

By early detection in the Ex-area you can prevent damage or contain existing damage.

When operating biogas plants, besides process optimization and process monitoring of the fermentation process, personal protection and plant safety are of crucial importance. MSR-Electronic offers intelligent devices to extend the process optimization and operational safety of your biogas plant.

With the products of MSR-Electronic you work against dangers preventively. By monitoring in pump rooms to protect people from dangerous leaks or in the double diaphragm (biogas exhaust air hood) to ensure tightness and thus freedom from losses.

+ BENEFITS

- Devices pre-parameterized for your application (with pre-calibrated sensors)
- Easy connection to existing systems (analog, Modbus)
- 2 potential-free relays, e.g. to control warning devices
- Easy mounting by means of mounting bracket
- Modular design, individual configuration
- Various options like serial bus
- With and without display or keyboard



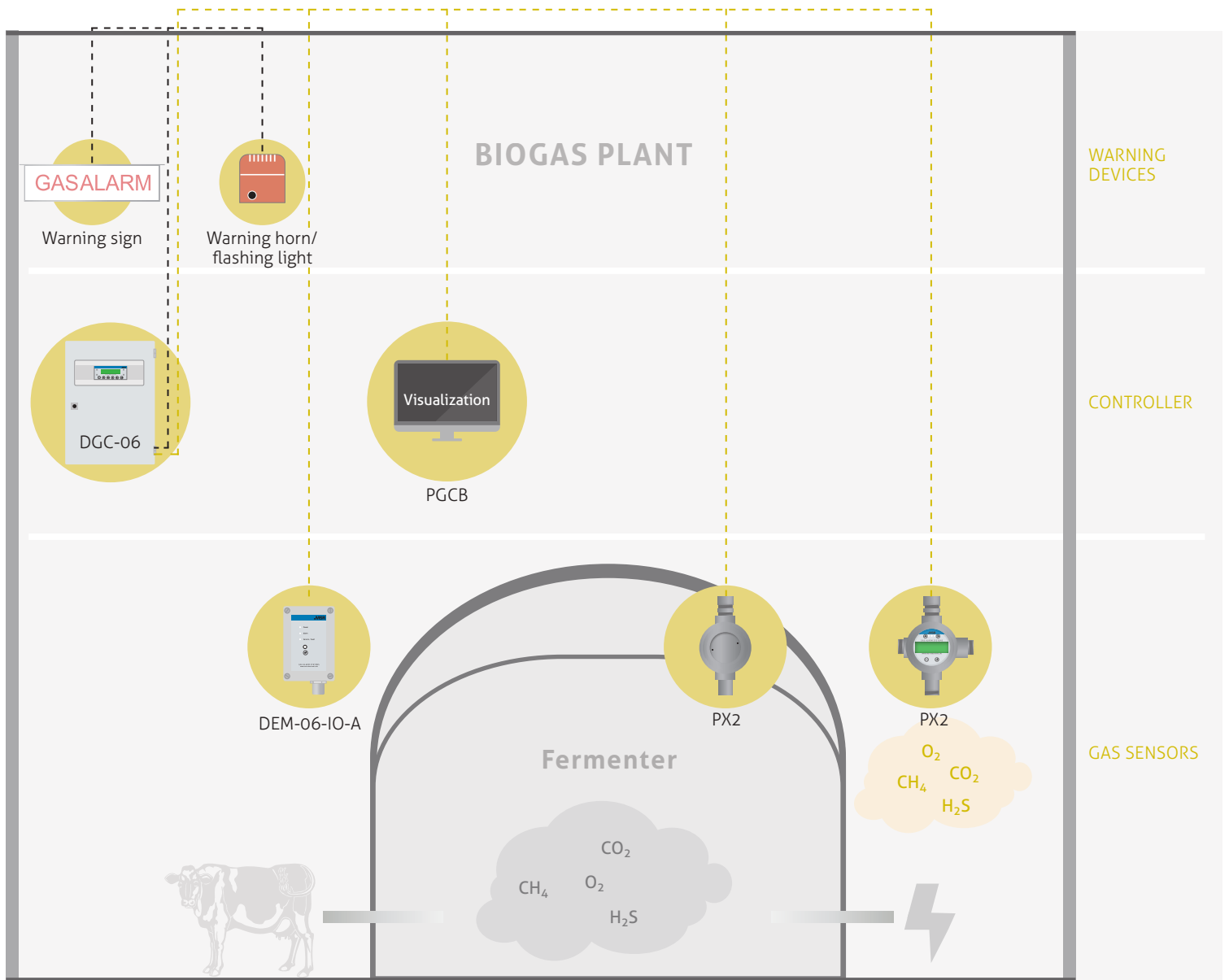

MSRSHOP24

Configure your product here: www.msr-24.com

Petrochemical Industry

Safe protection against CH_4 / C_5H_{12} / C_3H_8 / H_2S / O_2 / CO / NH_3

MSR-Electronic offers safe monitoring of combustible and toxic gases in petrochemical plants.

In the chemical and petrochemical industry, permanent monitoring of rooms and plants in which explosive or toxic atmospheres can form is required. Personal protection requires the monitoring of hazardous gases in accessible areas, on the one hand to prevent accidents, and on the other to comply with

MAK values and thus guarantee the health and safety of employees. In addition, MSR-Electronic offers solutions for the protection of your plant against unwanted gas leakage and thus financial loss. Furthermore, process safety can be further optimized with gas detectors from MSR-Electronic.

+ BENEFITS

- Protected according to IP66
- Preconfigured devices on request
- Easy integration into existing systems
- 2 potential-free relays per device
- Modular design and individual configuration
- Various options like relay, display, keyboard or housing variations



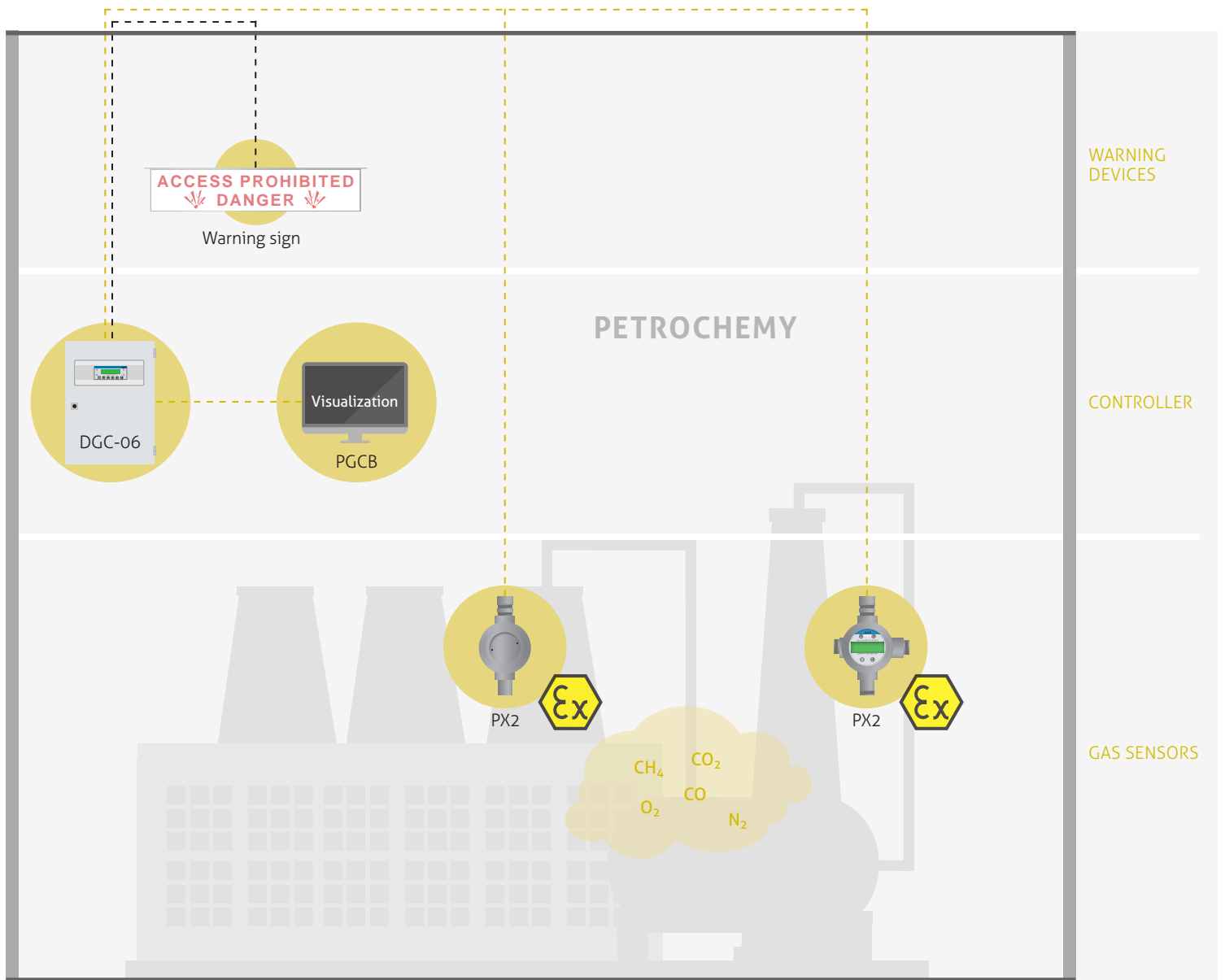

MSRSHOP24

Configure your product here: www.msr-24.com

H₂-Gas Monitoring

for research, production, logistics and mobility

The permanent gas monitoring serves the primary explosion protection and thus also the plant safety.

There are numerous applications for hydrogen as the energy carrier of the future. Apart from its use in welding or as fuel for rockets, the focus is currently mainly on the automotive sector. Hydrogen combustion engines or fuel cells are expected to replace fossil fuels in the foreseeable future. No local exhaust gases are produced when hydrogen is burned, only water. H₂ is a very reactive gas, which makes constant monitoring by a gas warning system throughout

its life cycle absolutely essential. During research work, on test benches and during the production of the gas, leaks can occur at any time and cause catastrophic damage in case of ignition. Warning systems must also be installed during transport and at filling stations to protect people and equipment from this highly flammable gas. The SIL2-certified PolyXeta®2 sensor with X-Change technology is used for successful gas monitoring.

+ BENEFITS

- A solution for individual requirements such as production as well as transport and storage
- Sensors are delivered calibrated and individually preconfigured on request
- Easy connection to existing systems (analog, Modbus)
- 2 potential-free relays, e.g. to control warning devices
- Easy assembly using a mounting bracket
- Modular design for any adaptation of the system
- Various options, such as relay, display, keyboard or housing variations
- SIL2 certified PolyXeta®2 sensors for ATEX zones 1 and 2



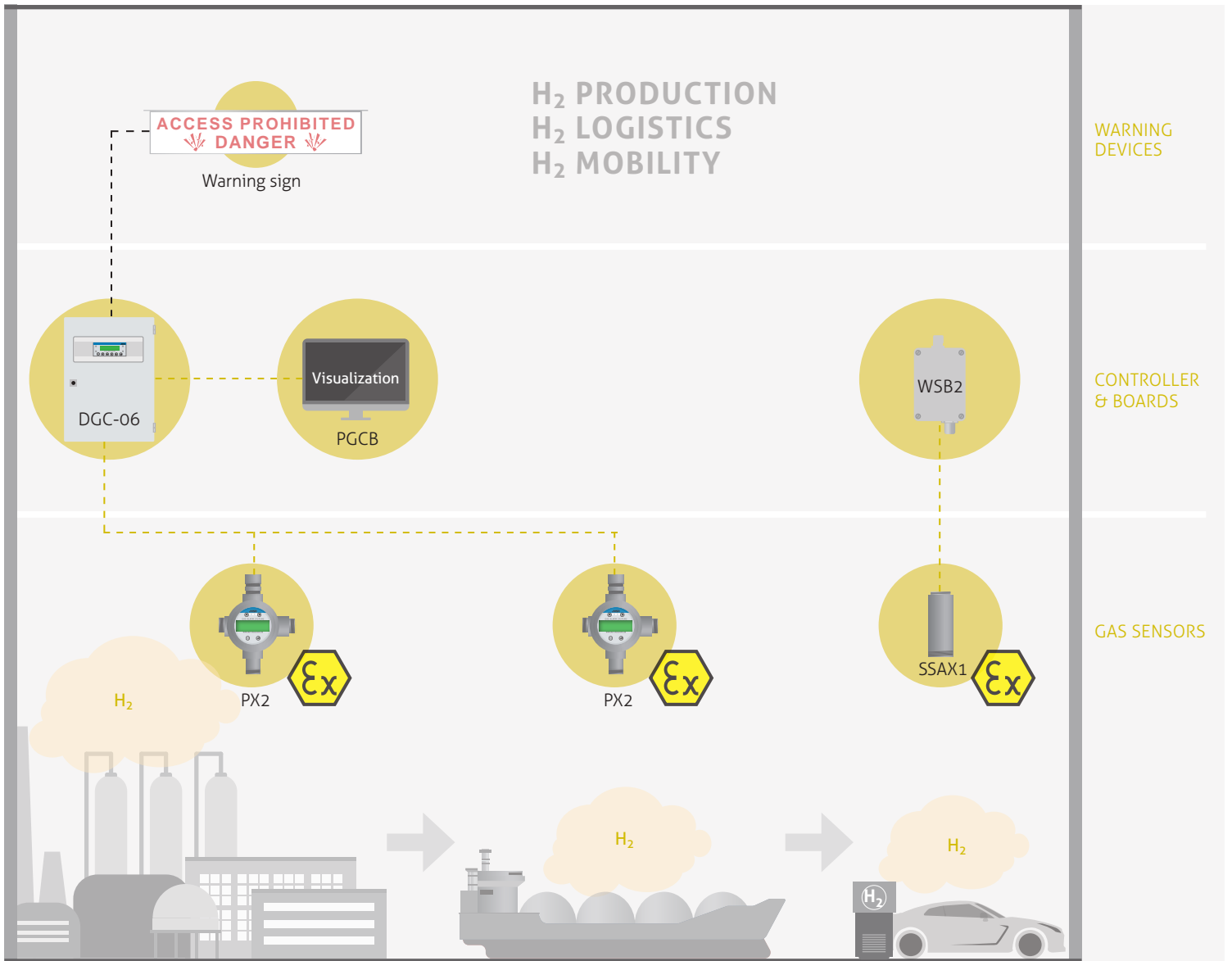

MSRSHOP24

Configure your product here: www.msr-24.com

Further Applications

Safe applications for zone 1 and zone 2

MANUFACTURING INDUSTRY

Protection against these gases: O_2 / H_2S / CO / CO_2

Health-endangering gases are used in many manufacturing industrial companies. To effectively protect workers in these areas, the ambient air must be continuously monitored for the concentration of toxic gases or the threatening drop in oxygen level.

MINING

Protection against these gases: CH_4 / C_5H_{12} / C_3H_8 / H_2S / O_2 / CO / NH_3

Mines are dangerous environments for people and mining equipment and the risk of fire, explosion and oxygen deficiency is always present. All gases released during mining should be continuously monitored. MSR-Electronic provides the products to minimize this risk potential and can thus contribute to the health and safety of the mining industry.

OFFSHORE

Protection against these gases: CH_4 / C_5H_{12} / C_3H_8 / H_2S / O_2 / CO / NH_3

In offshore facilities, gas warning systems can immensely reduce fire and explosion risks, as they warn of dangerous situations at a very early stage. MSR-Electronic develops and produces reliable stationary gas detectors that permanently monitor the ambient air for methane, propane and hydrocarbons and thus protect human lives and material assets.



GAS INDUSTRY

Protection against these gases: CH_4 / H_2S / CO_2 / O_2

All companies involved in the production and processing of gases need safe protection against explosions or poisoning of the people working there. Permanent monitoring and recording of the measured values serve primary explosion protection and thus plant safety.

DISPOSAL

Protection against these gases: CO_2 / H_2S / Hexane / Benzene / Toluene

Employees in the utility and waste management industry are exposed to gas hazards in many areas. In sewers there is the possibility that the oxygen content of breathing air can be reduced, in waste disposal sites however toxic or explosive gases are produced. In addition, it may be necessary to detect damage or leaks in pipelines.







PolyXeta[®] 2

for ATEX zone 1 and 2



PolyXeta[®] 2

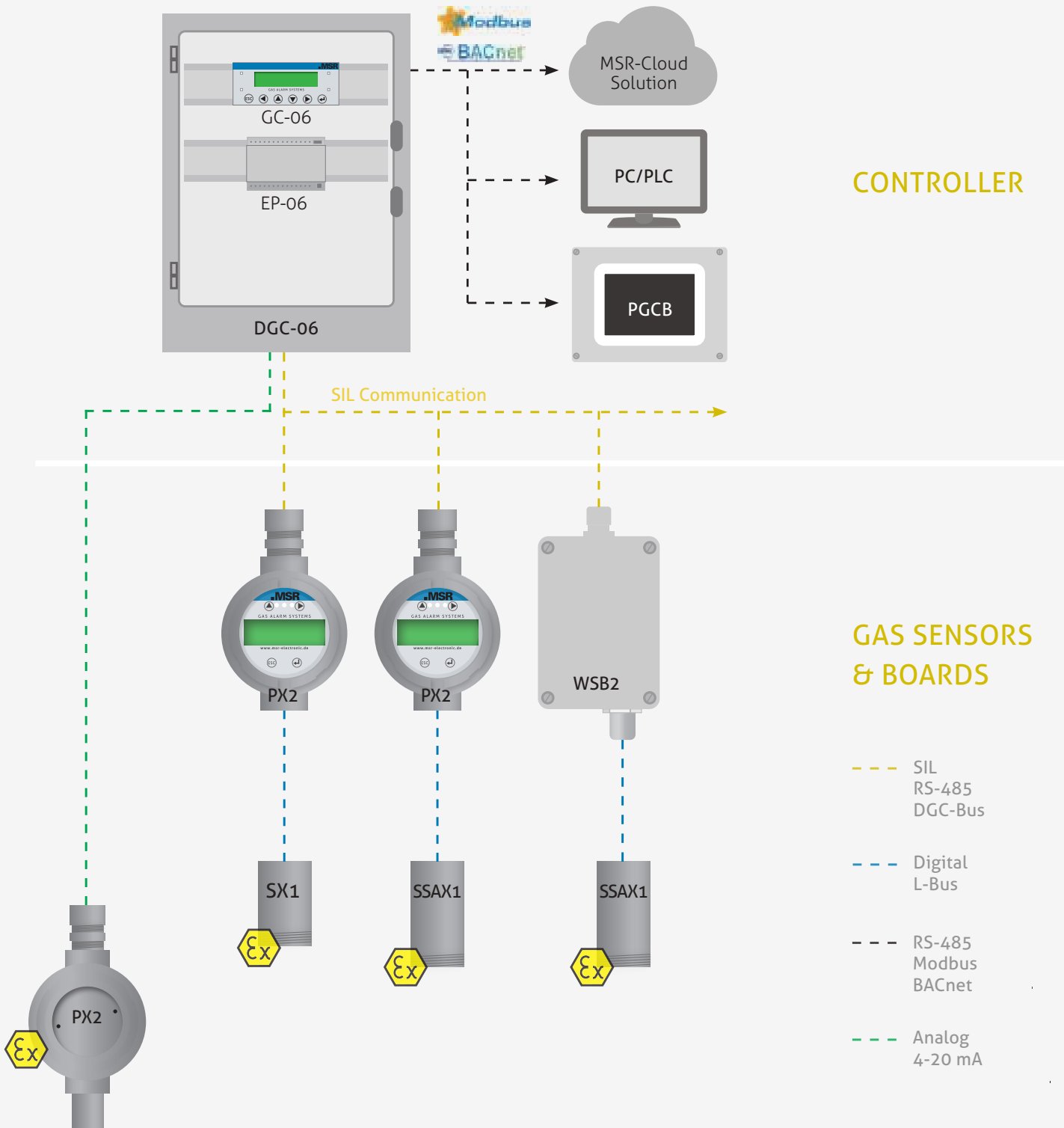

STOP MOTOR

GASALARM

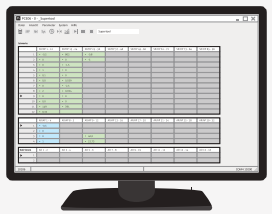

WARNING DEVICES & ACCESSORIES





HOW-TO VIDEO

Watch the video of the PolyXeta®2 commissioning

PolyXeta[®] 2 with Sensor SX1

Innovative exchangeable sensor with X-Change technology

PolyXeta[®] 2 with microprocessor supported sensor SX1.

4-20 mA output, RS-485-Modbus output

The sensor is suitable for connection to GC-05 and GC-06

OPTIONS	LC display
	2 relay outputs: Alarm and fault relay
VARIABLES	Ex demb[ib] Zone 1, opening of the housing possible during operation (on request)
	Ex db Ignition protection for zone 1 and 2
	Ex nA Ignition protection for zone 2

PolyXeta[®]2 sensor components with sensor cartridge SX1 (X-Change technology)
Communication: L-Bus



BENEFITS

- Signal output analog, Modbus
- Connection to DGC-06, MSC2, MSB2, WSB2
- Digital calibration
- X-Change housing with NPT 3/4"-threaded connection, protection type IP65

SX1 sensor cartridge



housing + sensor board

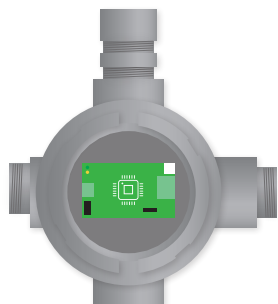

PolyXeta[®]2 without display

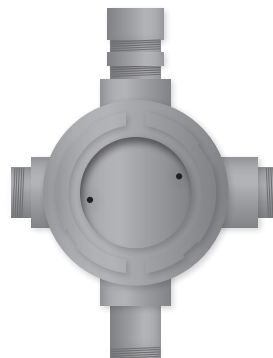

PolyXeta[®]2 with LC display

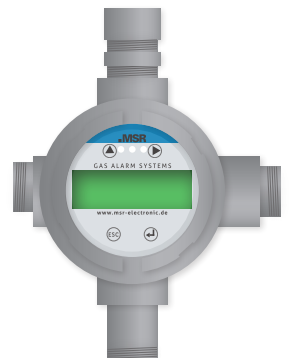

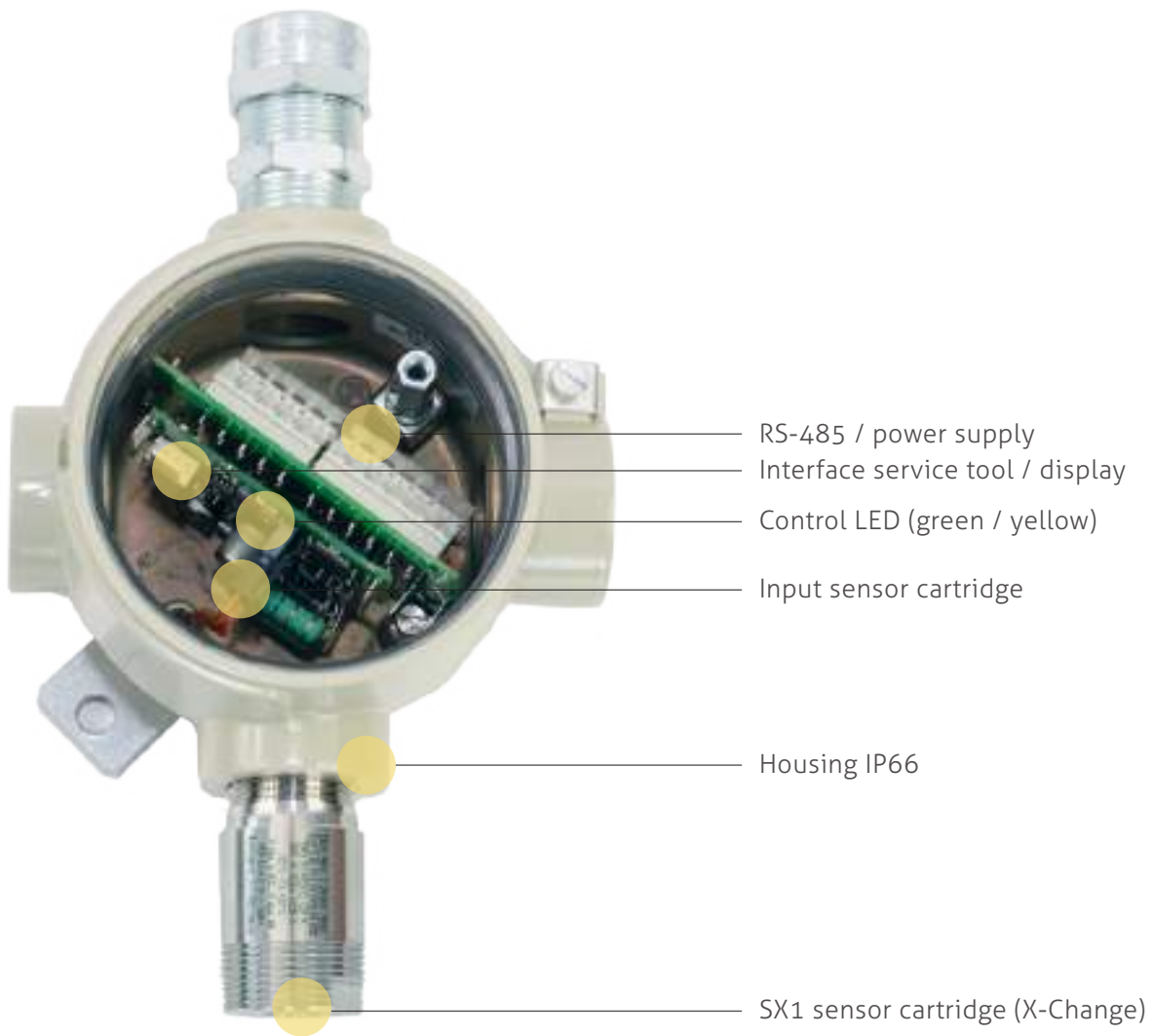

MSRSHOP24

Configure your product here: www.msr-24.com

PolyXeta[®] 2 Sensor SSAX1

Sensor for remote applications

The ATEX sensor for combustible and toxic gases.

In addition to the high-quality sensor element and the measuring amplifier, the sensor cartridge SSAX1 contains a μ Controller for processing the measured values. All relevant data and measured values of the sensor element are stored in the μ Controller in a fail-safe manner and are transmitted digitally via the local bus

to the WSB2 or output as PWM signal (pulse width modulation). The calibration management is also integrated in the μ Controller of the sensor cartridge. Calibration can be carried out by simply changing the sensor cartridge or by the integrated, convenient calibration routine directly at the system.

+ BENEFITS

- ATEX and IECEx certificates for electrical explosion protection
- SSAX1 for zone 1 (also applicable in zone 2):
Version "Ex d" with flameproof enclosure
- Continuous monitoring of toxic and flammable gases and oxygen
- Different measuring principles depending on customer requirements and application (infrared, electrochemical sensor, pellistor)
- High accuracy, selectivity and reliability
- Easy calibration
- Reverse polarity protected
- Overload protection
- 5 m cable length



ATEX sensor SSAX1



The new SSAX1 enables the ATEX certified sensor head to be placed alone in the danger zone and to be led out of the danger zone to a WSB2 with the corresponding ATEX cable in

order to carry out the evaluation of the sensor there. The SX1 is connected directly to the PX2 and can therefore be used as a complete device in the ATEX zone.

PolyXeta®2 devices and sensors in the ATEX area

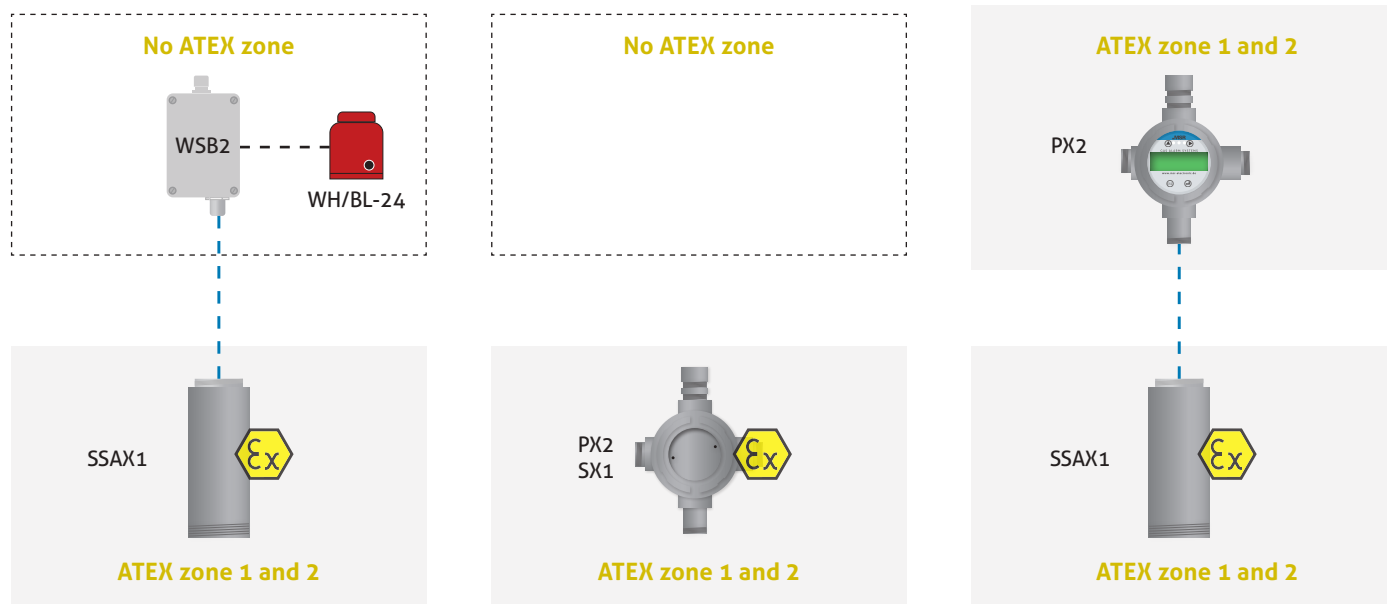

MSRSHOP24

Configure your product here: www.msr-24.com

X-Change Technology

Der PolyXeta®2 exchangeable sensor SX1 and SSAX1

Time-saving calibration of MSR gas alarm sensors.

Until now, the necessary calibration of the sensors was a complex procedure and dependent on an external certified company. This involved a lot of time and money. The sensors had to be opened, checked and calibrated with great care at the construction site. If an error occurred, it was necessary to take the complete

sensor with you and replace it afterwards. With the new X-Change technology this effort can be saved. The exchangeable cartridge can be replaced on site at any time. The transmitter therefore remains untouched. This saves time and costs.

+ SIMPLE AND INDEPENDENT RECALIBRATION

- Significant time and cost savings
- Simple change process
- Delivery of newly calibrated sensor cartridges
- Increasing the safety of your system

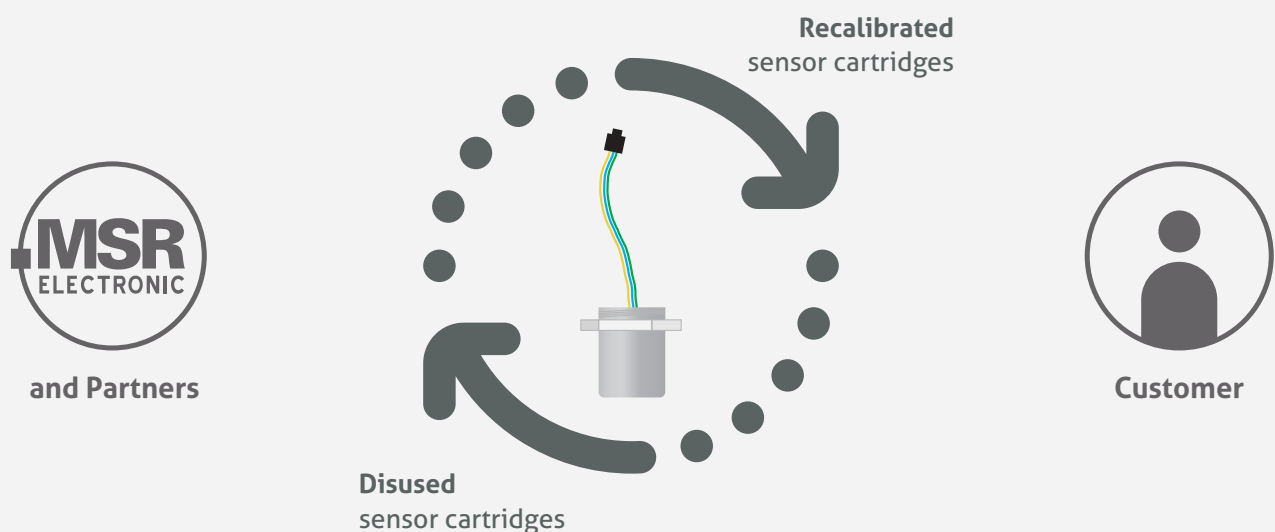

HOW-TO VIDEO

Take a look at the simple exchange process in the video.



Quick and safe sensor exchange



Loosen the locking screw with an Allen key (1.5 mm) and open the housing.



Loosen the sensor cable and unscrew the used sensor head. **The yellow LED lights up.**



Replace the sensor cartridge and connect the cable of the recalibrated cartridge to the board. **The yellow LED goes off again.**



Close the housing again and recalibrated sensor is immediately ready for use.

Gas-Controller

Freely extendable for your requirements

System for toxic, combustible gases and vapors.

The industrial controller DGC-06 is designed for extreme environmental conditions in combination with the PolyXeta®2 line. The controller can monitor and evaluate up to 128 gas sensors, including 96 digital PolyGard®2 or PolyXeta®2 and/or 32 analog (4-20 mA) sensors. For alarm signals, the innovative controller system has up to

32 alarm relays with potential-free change-over contact and up to 16 analog outputs with 4-20 mA signal. Freely adjustable parameters and setpoints allow flexible use in gas measurement technology. However, simple and convenient commissioning is also possible through configuration with standard parameters.

+ BENEFITS

- 128 sensors
- Relay expandable with EP-80 modules
- Extra large, easy to read and illuminated touch display (optional)
- Service Tool for configuration
- Direct connection to the building control system
- GC module integrated
- UPS / datalogger (optional)
- Can be installed in switch cabinet
- Safety product
- Available in different versions on request





Steel housing

GC-06 module with display and keyboard

EP-06 module



MSRSHOP24

Configure your product here: www.msr-24.com

Modules

Measurement, warning and control controller

Extend the control.

The modules are designed to perfectly complement the centralization of the overall PolyXeta®2 system. The controllers, such as the GC-06, are the core elements of the systems. Extension modules, like the EP-06, provide additional inputs and outputs. Since MSR-Electronic has extensive certifi-

cation and many years of experience in the manufacture of controllers, professional preparation for complex acceptance tests is guaranteed. The modular technology allows for compact yet flexible and highly efficient systems.



BENEFITS

- Extension module with
 - 4 analog inputs (4-20 mA)
 - 4 alarm relays with potential-free changeover contact
 - 2 analog outputs (4-20 mA)
- For connection to the PolyXeta®2 gas controller GC-06
- Modular design of the system possible
- Individual configuration
- A wide range of options
- Serial Bus



MSRSHOP24

Configure your product here: www.msr-24.com

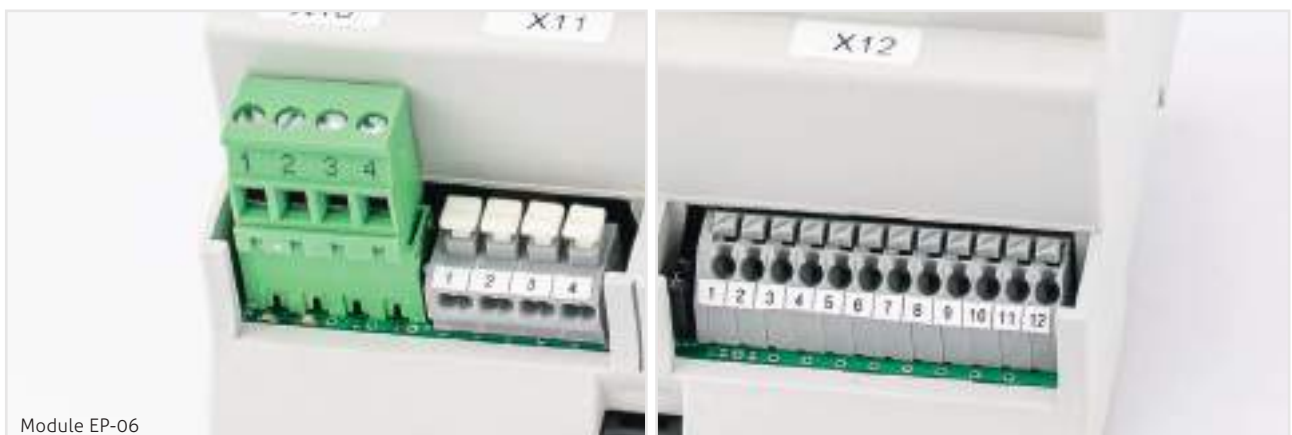

Module GC-06

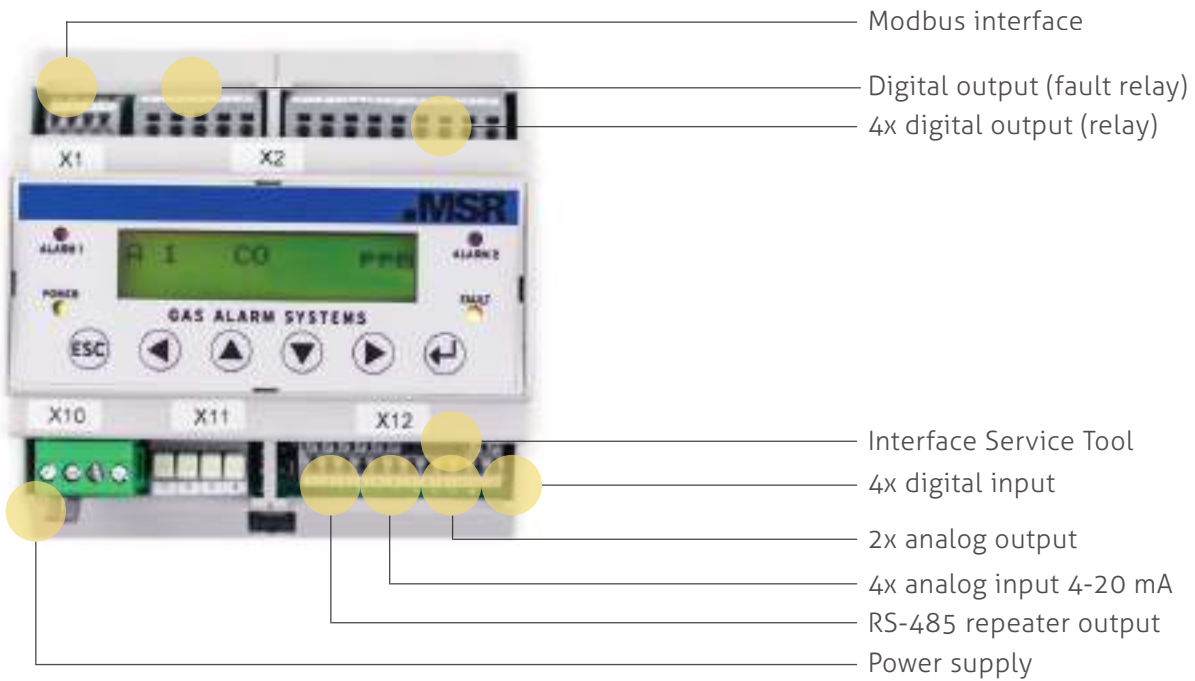

Extension module EP-06 for GC-06

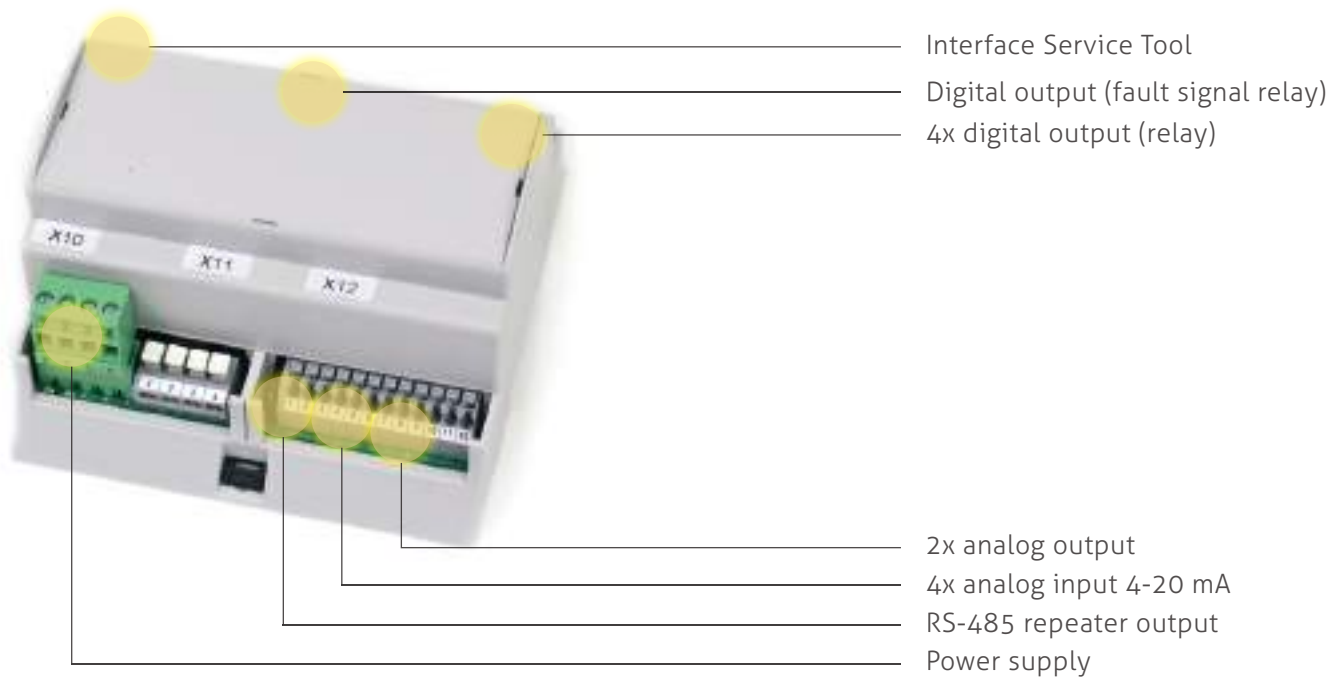

Warning Devices

Reliable warning in ATEX zone 1 / 2

For areas where special requirements exist due to explosive substances.

MSR-Electronic offers an extensive repertoire of acoustic and optical signaling devices with various approvals for use in hazardous areas. The signal transmitters of the Ex series are characterized by a particularly robust design and insensitivity to environmental influences and chemicals. These are information, warning and emergency signals for safety, hazard and

fire alarm systems, building, industrial and commercial automation, disaster warning and danger areas. The products are suitable for use in gas and steam atmospheres as well as in dust atmospheres. MSR-Electronic offers Ex signal towers, optical, acoustic and optical-acoustic Ex signal devices.

+ BENEFITS

- Compatible to all controllers from MSR-Electronic
- For use in zone 1 and zone 2
- Durable and robust





WARNING HORN AND XENON FLASHING LIGHT

- Explosion-proof LED multifunctional light
- Double / triple door opener flash



OMNIDIRECTIONAL XENON FLASHING LIGHT

- Xenon flashing light
- Suitable for zone 1 and 2
- Approved according to IECEx, ATEX, Ex EAC



WARNING HORN

- Suitable for zone 1 and 2
- Flame retardant ABS



MSRSHOP24

Configure your product here: www.msr-24.com

PolyMarine

Gas warning systems for ships

Ships are risk areas, as there is no possibility to escape. This means that dangers must be recognized early on in order to avert higher hazards. With PolyMarine products from MSR-Electronic you are on the safe side on board. The line offers perfect protection

against gas leakage on board. These leaks are often imperceptible to the sense of smell or only when an accident can no longer be avoided. The gas warning systems and warning devices of PolyMarine offer reliable safety.

+ BENEFITS

- **More safety**
More than all national standards require
- **Exchangeable sensor X-Change technology**
Significantly lower maintenance costs
- **Accurate planning with lower overall costs**
- **Integration into the ship system**
(e.g. Modbus)





MSR
**SAFETY
FIRST**

PolyMarine

Leakage protection for private shipping

Reliable and durable protection against gas leaks on board.

Gas leaks on board can quickly lead to fire and poisoning. Many of these gases are often odorless. The human sense of smell can no longer recognize this danger and is therefore dependent on help. In addition, the escape of combustible gases can quickly cause a fire or even an explosion.

PolyMarine products

- Gas controller: up to 3 different gas sensors possible
- Gas sensors for CO / NO₂ / gasoline vapors or Propane, incl. sensor with X-Change technology
- Warning device: warning horn with signal lamp and alarm acknowledgement
- Control unit for the cockpit with buzzer, lamp, button and display
- Smoke detector, magnetic gas valve



BENEFITS

- High accuracy and reliability
- Guaranteed safety and worldwide support
- Significant increase in value



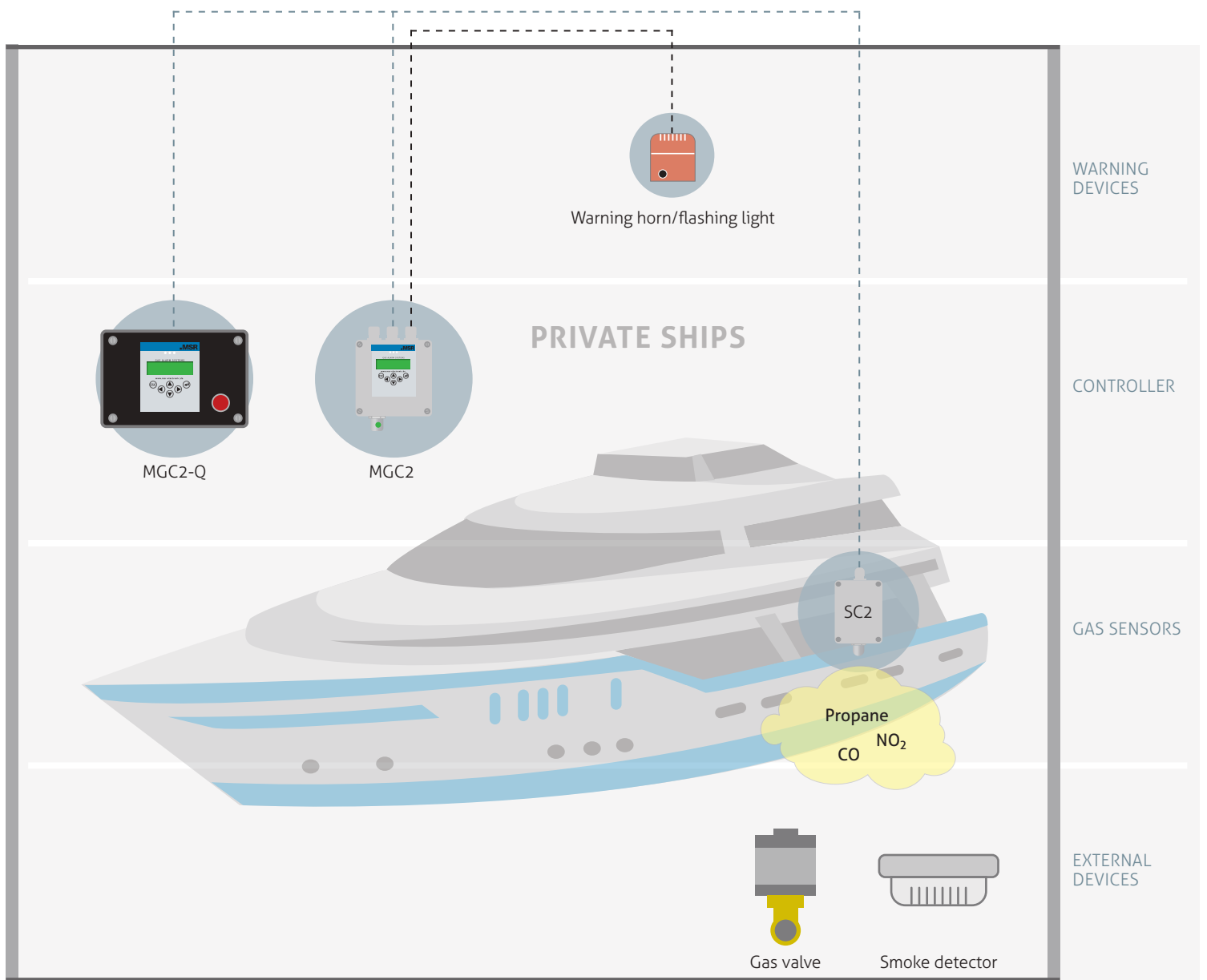

APPROVALS
(pending)



PolyMarine

Leakage protection for commercial shipping

Gas alarm systems for commercial shipping.

Depending on the type of ocean-going vessel and its cargo, dangerous gas concentrations can form on board at any time. According to the guidelines, fixed gas detection systems must be installed in most ships. In addition, a reliable gas warning system from MSR-Electronic not only protects the life of the crew, but can also protect the cargo of the ship and even the ship itself from damage.

LPG – alternative marine fuel

The use of liquid gas as a fuel is increasing rapidly worldwide. The properties of LPG and especially its low exhaust fumes and virtually particle-free emissions, can have an immediate

positive effect on air quality. When liquid gas leaks unnoticed on a ship, it finds its way into the engine room or bilge. Reliable and powerful stationary LPG gas detectors from MSR-Electronic will make the future of shipping safer here.

Other gas hazards in ships

- Explosion risk with liquefied gas, chemicals and other fossil fuels
- Toxic gases: Carbon monoxide from exhaust gases and hydrogen sulfide from the decomposition of organic compounds
- Risk of suffocation: Lack of oxygen during oxidation processes



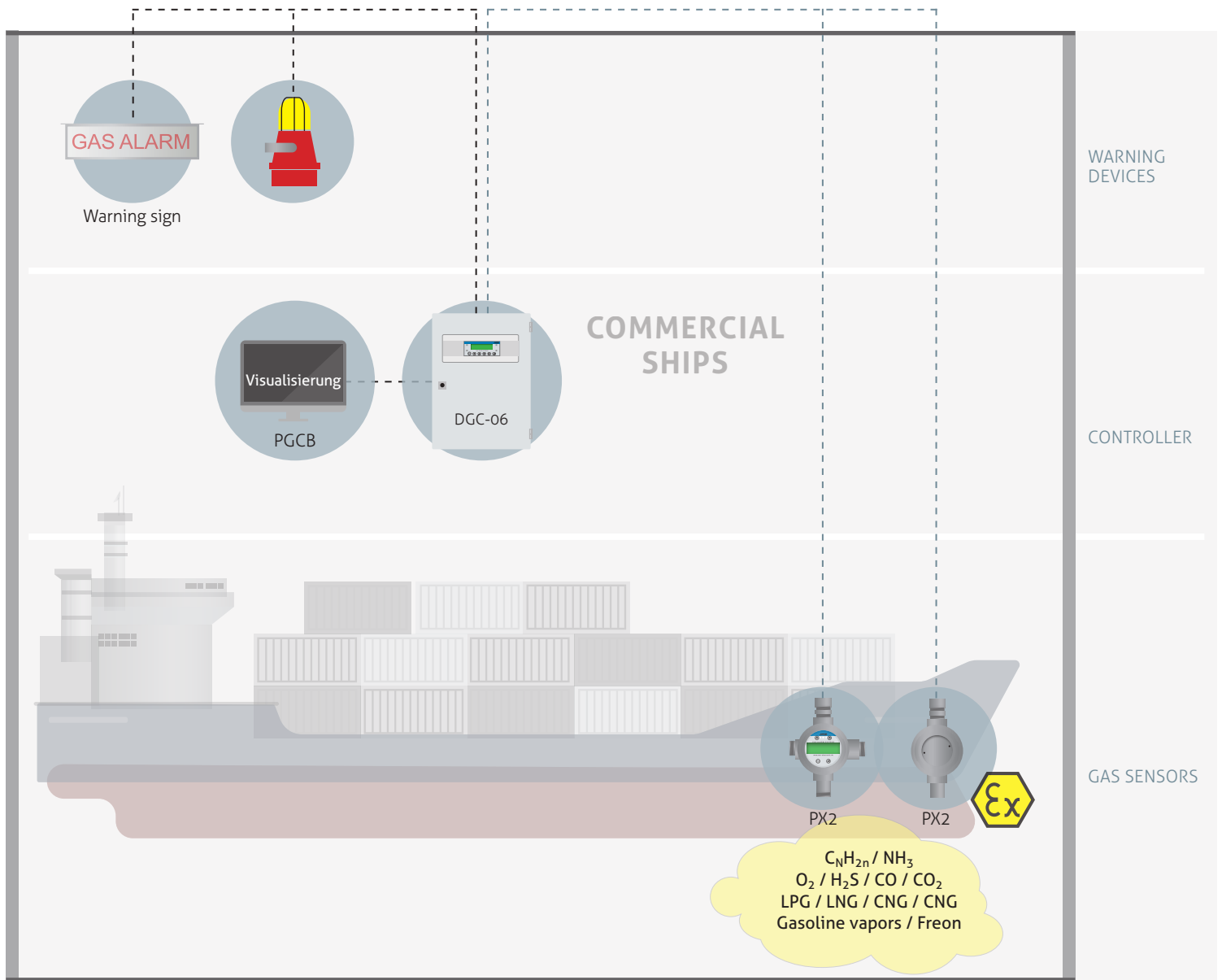

APPROVALS
(pending)



On
request

PolySam®

Gas analysis system for process optimization

With PolySam® MSR-Electronic offers individual solutions for complex applications. You benefit from comprehensive analyses and optimize your energy generation yield. In addition to gas conditioning, the system offers an extensive interface function. You can go

to further control panels via Modbus, analog output or relay. These systems are individually designed together with the customer. Here each application is a separate project. However, the modular X-Change technology and the complete controller line can always be used.

+ BENEFITS

- **More safety**
More than all national standards require
- **Exchange sensor X-Change technology**
Significantly lower maintenance costs
- **Accurate planning with lower overall costs**





.MSR
**SAFETY
FIRST**

PolySam[®] Gas Analysis

Gas analysis system for process optimization

System for gas analysis - self-regulating gas intake system with integrated controller.

With the gas analysis system, it is possible to monitor a wide variety of processes in which gases are released. The system prepares the gas mixture so that it can be analyzed independently. This is often necessary with hot exhaust gases or oxygen-free atmospheres. The analysis system also makes integration

into existing systems easy. Because of different digital (Modbus, BACnet, TCP/IP) and analog (4-20 mA, 2-10 V, or various relays) connections the installation is very easy and flexible. This allows the system to be remotely monitored and controlled.

+ BENEFITS

- Ultra flexible gas analysis system
- Up to 4 gas sensors per string can be installed for evaluation
- Adjustable flow rate of the sample gas
- Automatic detection of clogged filters
- By using sample gas coolers, filters, heaters and much more, you can react to all conditions with the matching PolySam[®]
- Integration into process control systems possible
- Selection of different interfaces
- Also available as compact system for 1 gas



PolySam® ANALYSIS DEVICE

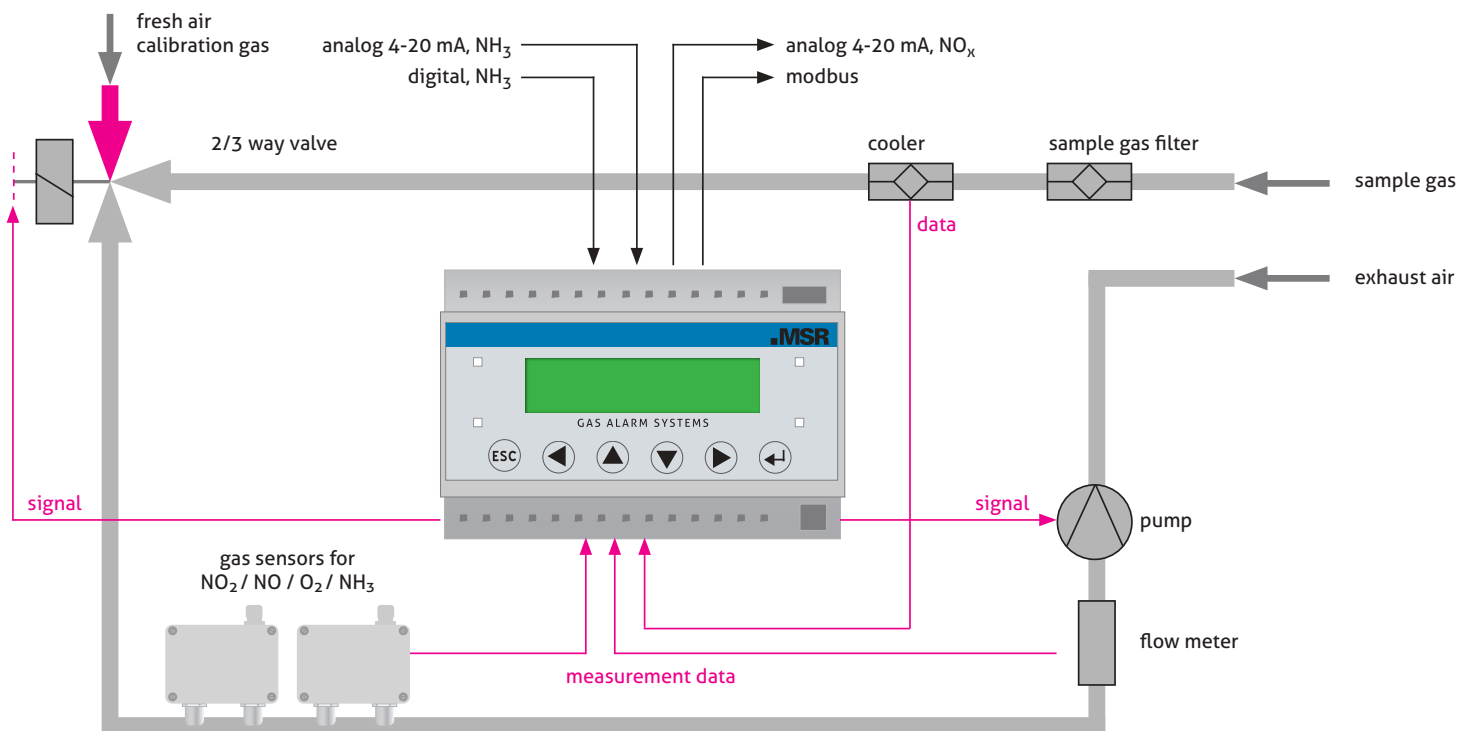

Appendix

122	MSR-Academy
124	The MSR-Product Configurator
126	OEM Customizing/Branding
128	HOW TO: The Video World
130	Products and Options
154	Housings
158	Product Codes
160	Product Matrix
162	Product Directory
164	Worldwide Sales
166	MSR-Group



MSR-Academy

User knowledge directly from the manufacturer

MSR-Electronic is a supplier of the latest safety technology in the gas detection sector. To ensure that the systems meet the high requirements of the customers, in-depth knowledge of applications, products, maintenance and legal regulations is necessary.

Customers of MSR have the opportunity to experience the technology up close while participating in a **BASIC webinar** and a further 2-day **ADVANCED training course** in Pocking and to get to know the gas detection system

in detail in close collaboration with the technology and development experts. This means that errors can be avoided during the design of the system and the customer can be offered a reliable gas alarm system.

The training will cover our new Product line PolyGard®2, PolyXeta®2, the existing line µGard®, PolyGard®, as well as legal innovations such as the European standard EN 50545 for garages and tunnels.



MSR-ACADEMY

Your MSR contact person will be happy to inform you of current dates or you can find out more at www.msr-electronic.de/en/academy/

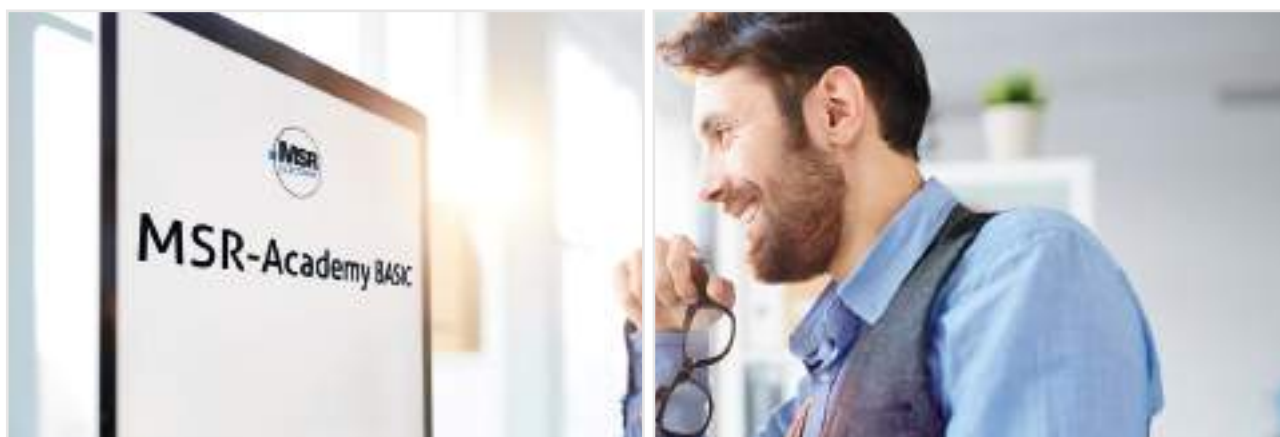

The MSR-Academy supports the establishment of professional customer service and thus offers the possibility of faster processing of day-to-day business.

+ Benefits

- **Free premium support code*** with regular training participation
- **Precise product knowledge from the MSR product family**
- **News from the gas warning technology**
- **Mediation of complex application examples**
- **Close exchange with MSR development department and support**
- **After successful training, fault messages are recognized and eliminated more quickly**

* Every participant receives a premium support code: By regularly participating in the MSR-Academy, you will receive free support from our technicians for a period of 18 months.



MSR-Product Configurator

With Webshop www.msr-24.com

The webshop of MSR-Electronic with more than 1 000 products and unique product configurator.

With this variety of applications and requirements it is not always easy to find the right product.

At www.msr-24.com customers can enter the key data (e.g. application and room size) of the project in the product configurator. Then

they immediately receive a proposal with the required products and the appropriate number of items, in accordance with the currently applicable standards. This can be adapted to individual requirements.

+ BENEFITS

- Use as configurator and/or Webshop
- All products are easy to find
- Different versions of articles can be configured individually
- The selected article is displayed with product photos, a data sheet and the respective unit price

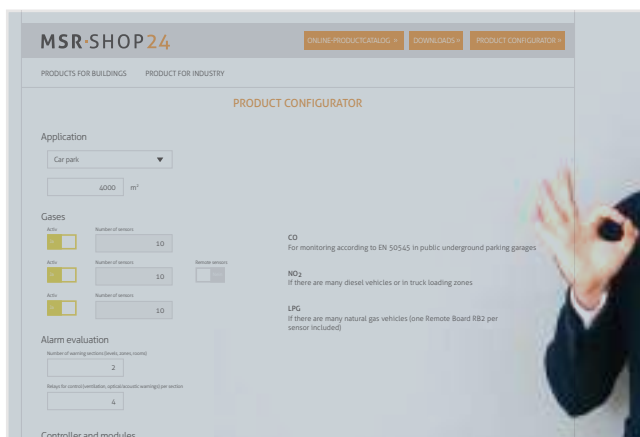

MSR SHOP 24

[ONLINE-PRODUCTCATALOG >>](#)

[DOWNLOADS >>](#)

[PRODUCT CONFIGURATOR >>](#)

PRODUCTS FOR BUILDINGS
PRODUCT FOR INDUSTRY

PRODUCT CONFIGURATOR

Application

Car park
▼

4000
m²

Gases

Activ	<input checked="" type="checkbox"/>	Number of sensors	<input type="text" value="10"/>	
				CO For monitoring according to EN 50545 in public underground parking garages
Activ	<input checked="" type="checkbox"/>	Number of sensors	<input type="text" value="10"/>	
				NO₂ If there are many diesel vehicles or in truck loading zones
Activ	<input checked="" type="checkbox"/>	Number of sensors	<input type="text" value="10"/>	
				LPG If there are many natural gas vehicles (one Remote Board RB2 per sensor included)

Remote sensors

 Yes

Alarm evaluation

Number of warning sections (levels, zones, rooms)

2

Relays for control (ventilation, optical/acoustic warnings) per section

4

Controller and modules

Digital sensors	Analog sensors	
<input checked="" type="checkbox"/> Yes	<input type="checkbox"/> No	
Number of controllers	Number of extension modules	Controller
<input type="text" value="1"/>	<input type="text" value="1"/>	<input type="text" value="DGC06"/>

Add to Shopping cart



MSR SHOP 24

Configure your product at
www.msr-24.com

OEM Customizing/Branding

Based on the modular principle

MSR-Electronic is a manufacturer of stationary gas warning systems with decades of experience in the field of building automation and gas measurement technology.

From a certain quantity for a product, customizing of the sensors and controllers is possible. This starts with individual lasering and labeling and extends to special requests for configuration and extensions.

In addition to the implementation of customer-specific requirements with regard to device approval, we support our clients in numerous

industries in complying with all current national and international regulations on product safety and technical market safety requirements.

Contact us and learn more about the possibility of personalization.

info@msr-electronic.de

YOUR PROJECT TEAM

Initiation, planning, execution, monitoring and control

A specially coordinated project team will work with you to create the product requirement profile based on the modular principle. During the individual development stages, monitored

by the MSR quality management, up to the release sample (PPAP) and subsequent series production, we are in close contact with you.



Applications

- Tunnel
- Parking garage
- Building
- Industry
- Petrochemistry
- Biogas Plant
- Shipping
- and more



Gases

- CO₂
- NH₃
- CH₄
- and more

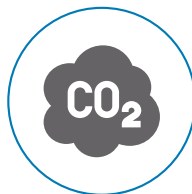

Sensor Principles

- Infrared
- Electrochemical
- Semiconductor
- Catalytic



Housing

- Design
- Form
- Color
- Logo
- Lettering
- IP protection class
- and more

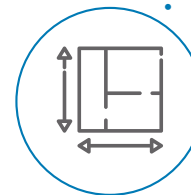

Accessories

- Acoustic: horn, buzzer
- Optical: Flashing light
- Warning sign
- and more



Assembly

- Standard in housing
- Remote with cable

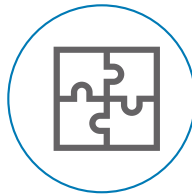

More Features

- Relay
- Display
- Analog / digital outputs
- Analog / digital Inputs
- Modbus, BACnet
- and more

Approvals

- EN 378
- EN 14624
- EN 50545
- EN 60079-29-1
- ATEX
- EN 60079
- and more



HOW TO: The Video World

MSR-Explanatory Videos on YouTube

Explore the MSR-Electronic product world digitally.

How-to is the keyword on YouTube. MSR explanatory videos provide brief and concise information on important details for the commissioning of selected products. Knowledge can thus be conveyed quickly. Basically,

e-learning is location-independent. Usually only a laptop, tablet or smartphone and an Internet connection are required. Complex things simply explained.



MSR-Electronic YouTube Channel



Commissioning

Warning and Sensor Board WSB2



Recalibration

MSR sensors with Service Tool STL06



Commissioning

Multi Sensor Controller MSC2



X-Change technology

Simple exchange process PolyXeta®2 sensor cartridge



Commissioning

PolyXeta®2



X-Change technology

Simple exchange process PolyGard®2 sensor cartridge



Recalibration

MSR sensors with display version



MSR-Electronic

Fixed gas alarm systems,
Made in Germany



LinkedIn

Network with MSR-Group at www.linkedin.com and receive regular news from MSR-Electronic.

Analog Sensor Cartridge MC2

Toxic Gases

Item No.	Gas		Measuring Range
EL. Chem. Sensor			
MC2-A-E1110-BX	Carbon monoxide	CO	0-100 ppm
MC2-A-E1110-CX	Carbon monoxide	CO	0-150 ppm
MC2-A-E1110-EX	Carbon monoxide	CO	0-250 ppm
MC2-A-E1110-FX	Carbon monoxide	CO	0-300 ppm
MC2-A-E1110-HX	Carbon monoxide	CO	0-500 ppm
MC2-A-E1125-AX	Ammonia*	NH ₃	0-100 ppm
MC2-A-E1125-BX	Ammonia*	NH ₃	0-300 ppm
MC2-A-E1125-CX	Ammonia*	NH ₃	0-500 ppm
MC2-A-E1125-DX	Ammonia*	NH ₃	0-1000 ppm
MC2-A-E1125-EX	Ammonia*	NH ₃	0-5000 ppm
MC2-A-E1130-AX	Nitrogen dioxide	NO ₂	0-10 ppm
MC2-A-E1130-BX	Nitrogen dioxide	NO ₂	0-20 ppm
MC2-A-E1130-CX	Nitrogen dioxide	NO ₂	0-30 ppm
MC2-A-E1130-EX	Nitrogen dioxide	NO ₂	0-100 ppm
MC2-A-E1183-BX	Hydrogen cyanide	HCN	0-50 ppm
MC2-A-E1183-CX	Hydrogen cyanide	HCN	0-100 ppm
MC2-A-E1185-BX	Formaldehyde	CH ₂ O	0-10 ppm
MC2-A-E1186-DX	Hydrogen chloride	HCL	0-20 ppm
MC2-A-E1187-AX	Phosphine	PH ₃	0-5 ppm
MC2-A-E1188-AX	Silane	SiH ₄	0-50 ppm
MC2-A-E1189-CX	Ethylene	C ₂ H ₄	0-200 ppm
MC2-A-E1190-AX	Ozone	O ₃	0-5 ppm
MC2-A-E1190-BX	Ozone	O ₃	0-10 ppm
MC2-A-E1193-CX	Chlorine	Cl ₂	0-10 ppm
MC2-A-E1193-DX	Chlorine	Cl ₂	0-20 ppm
MC2-A-E1195-A2	Oxygen, 2 years	O ₂	0-25 % Vol
MC2-A-E1195-A3	Oxygen, 3 years	O ₂	0-25 % Vol
MC2-A-E1195-A5	Oxygen, 5 years	O ₂	0-25 % Vol
MC2-A-E1195-A7	Oxygen, 7 years	O ₂	0-25 % Vol
MC2-A-E1196-BX	Sulphur dioxide	SO ₂	0-20 ppm
MC2-A-E1197-AX	Hydrogen sulphine	H ₂ S	0-50 ppm
MC2-A-E1197-BX	Hydrogen sulphine	H ₂ S	0-100 ppm
MC2-A-E1197-CX	Hydrogen sulphine	H ₂ S	0-200 ppm
MC2-A-E1197-DX	Hydrogen sulphine	H ₂ S	0-500 ppm
MC2-A-E1199-AX	Ethylene oxide	C ₂ H ₄ O	0-10 ppm
Infrared Sensor			
MC2-A-I-S1164-BX	Carbon dioxide	CO ₂	0-5 % Vol
MC2-A-I-S1164-CX	Carbon dioxide	CO ₂	0-2 % Vol
MC2-A-I464-BX	Carbon dioxide	CO ₂	0-5 % Vol
MC2-A-I464-DX	Carbon dioxide	CO ₂	0-5000 ppm

* On request

Analog Sensor Cartridge MC2

Combustible Gases and Freons

Item No.	Gas		Measuring Range
Pellistor Sensor			
MC2-A-P3400-AX	Methane	CH ₄	0-100 % LEL
MC2-A-P3402-AX	LPG ¹⁾	LPG	0-100 % LEL
MC2-A-P3408-AX	Ammonia *	NH ₃	0-100 % LEL
MC2-A-P3410-AX	Ethylene	C ₂ H ₄	0-100 % LEL
MC2-A-P3415-AX	Cyclohexane, Hexane	C ₆ H ₁₂	0-100 % LEL
MC2-A-P3420-AX	Ethane, R170	C ₂ H ₆	0-100 % LEL
MC2-A-P3425-AX	Ethanol	C ₂ H ₅ OH	0-100 % LEL
MC2-A-P3427-AX	Ethyl acetate	C ₄ H ₈ O ₂	0-100 % LEL
MC2-A-P3430-AX	Benzol, Benzene	C ₆ H ₆	0-100 % LEL
MC2-A-P3435-AX	Hexane	C ₆ H ₁₄	0-100 % LEL
MC2-A-P3440-AX	Hydrogen	H ₂	0-100 % LEL
MC2-A-P3448-AX	Butyl acetate	C ₆ H ₁₂ O ₂	0-100 % LEL
MC2-A-P3450-AX	Methanol	CH ₃ OH	0-100 % LEL
MC2-A-P3458-AX	MEK	C ₄ H ₈ O	0-100 % LEL
MC2-A-P3460-AX	Butane	C ₄ H ₁₀	0-100 % LEL
MC2-A-P3468-AX	Isobutyl alcohol	C ₄ H ₁₀ O	0-100 % LEL
MC2-A-P3470-AX	Octane	C ₈ H ₁₈	0-100 % LEL
MC2-A-P3472-AX	Cyclopentane	C ₅ H ₁₀	0-100 % LEL
MC2-A-P3473-AX	Methyl acetate	C ₃ H ₆ O ₂	0-100 % LEL
MC2-A-P3475-AX	Pentane	C ₅ H ₁₂	0-100 % LEL
MC2-A-P3480-AX	Propane	C ₃ H ₈	0-100 % LEL
MC2-A-P3480-BX	Propane	C ₃ H ₈	0-30 % LEL
MC2-A-P3480-CX	Propane	C ₃ H ₈	0-5000 ppm
MC2-A-P3482-AX	Isopropyl alcohol	C ₃ H ₈ O	0-100 % LEL
MC2-A-P3485-AX	Acetone	C ₃ H ₆ O	0-100 % LEL
MC2-A-P3490-AX	Toluene	C ₇ H ₈	0-100 % LEL
MC2-A-P3491-AX	Heptane	C ₇ H ₁₆	0-100 % LEL
MC2-A-P3494-AX	Butadiene	C ₄ H ₆	0-100 % LEL
MC2-A-P3495-AX	Nonane	C ₉ H ₂₀	0-100 % LEL
MC2-A-P3496-AX	Gasoline vapors		0-100 % LEL
Refrigerant Sensor			
MC2-A-S20XX-XX-A-X	Freon	R134a, etc.	20-2000 ppm
Refrigerant Sensor in LEL range			
MC2-A-S2020-01-AX	Freon	R32	0-50 % LEL
MC2-A-S2020-02-AX	Freon	R455a	0-50 % LEL
MC2-A-S2020-03-AX	Freon	R454b	0-50 % LEL
MC2-A-S2020-04-AX	Freon	R1234yf	0-50 % LEL
MC2-A-S2020-05-AX	Freon	R1234ze	0-50 % LEL
Infrared Sensor			
MC2-A-I400-X-X	Methane	CH ₄	0-100 % LEL
MC2-A-I480-X-X	Propane	C ₃ H ₈	0-100 % LEL
* On request			
1) Liquid Petroleum Gases			

Digital Sensor Cartridge SC2

Toxic Gases

Item No.	Gas		Measuring Range
EL. Chem. Sensor			
SC2-E1110-BX	Carbon monoxide	CO	0-100 ppm
SC2-E1110-CX	Carbon monoxide	CO	0-150 ppm
SC2-E1110-EX	Carbon monoxide	CO	0-250 ppm
SC2-E1110-FX	Carbon monoxide	CO	0-300 ppm
SC2-E1110-HX	Carbon monoxide	CO	0-500 ppm
SC2-E1125-AX	Ammonia *	NH ₃	0-100 ppm
SC2-E1125-BX	Ammonia *	NH ₃	0-300 ppm
SC2-E1125-CX	Ammonia *	NH ₃	0-500 ppm
SC2-E1125-DX	Ammonia *	NH ₃	0-1000 ppm
SC2-E1125-EX	Ammonia *	NH ₃	0-5000 ppm
SC2-E1130-AX	Nitrogen dioxide	NO ₂	0-10 ppm
SC2-E1130-BX	Nitrogen dioxide	NO ₂	0-20 ppm
SC2-E1130-CX	Nitrogen dioxide	NO ₂	0-30 ppm
SC2-E1130-EX	Nitrogen dioxide	NO ₂	0-100 ppm
SC2-E1183-BX	Hydrogen cyanide	HCN	0-50 ppm
SC2-E1183-CX	Hydrogen cyanide	HCN	0-100 ppm
SC2-E1185-BX	Formaldehyde	CH ₂ O	0-10 ppm
SC2-E1186-DX	Hydrogen chloride	HCL	0-20 ppm
SC2-E1187-AX	Phosphine	PH ₃	0-5 ppm
SC2-E1188-AX	Silane	SiH ₄	0-50 ppm
SC2-E1189-CX	Ethylene	C ₂ H ₄	0-200 ppm
SC2-E1190-AX	Ozone	O ₃	0-5 ppm
SC2-E1190-BX	Ozone	O ₃	0-10 ppm
SC2-E1193-CX	Chlorine	Cl ₂	0-10 ppm
SC2-E1193-DX	Chlorine	Cl ₂	0-20 ppm
SC2-E1195-A2	Oxygen, 2 years	O ₂	0-25 % Vol
SC2-E1195-A3	Oxygen, 3 years	O ₂	0-25 % Vol
SC2-E1195-A5	Oxygen, 5 years	O ₂	0-25 % Vol
SC2-E1195-A7	Oxygen, 7 years	O ₂	0-25 % Vol
SC2-E1196-BX	Sulphur dioxide	SO ₂	0-20 ppm
SC2-E1197-AX	Hydrogen sulphine	H ₂ S	0-50 ppm
SC2-E1197-BX	Hydrogen sulphine	H ₂ S	0-100 ppm
SC2-E1197-CX	Hydrogen sulphine	H ₂ S	0-200 ppm
SC2-E1197-DX	Hydrogen sulphine	H ₂ S	0-500 ppm
SC2-E1199-AX	Ethylene oxide	ETO	0-10 ppm
Infrared Sensor			
SC2-I-S1164-BX	Carbon dioxide	CO ₂	0-5 % Vol
SC2-I-S1164-CX	Carbon dioxide	CO ₂	0-2 % Vol
SC2-I464-BX	Carbon dioxide	CO ₂	0-5 % Vol
SC2-I464-DX	Carbon dioxide	CO ₂	0-5000 ppm

* On request

Digital Sensor Cartridge SC2

Combustible Gases and Freons

Item No.	Gas		Measuring Range
Pellistor Sensor			
SC2-P3400-AX	Methane	CH ₄	0-100 % LEL
SC2-P3402-AX	LPG ¹⁾	LPG	0-100 % LEL
SC2-P3408-AX	Ammonia *	NH ₃	0-100 % LEL
SC2-P3410-AX	Ethylene	C ₂ H ₄	0-100 % LEL
SC2-P3415-AX	Cyclohexane, Hexane	C ₆ H ₁₂	0-100 % LEL
SC2-P3420-AX	Ethane, R170	C ₂ H ₆	0-100 % LEL
SC2-P3425-AX	Ethanol	C ₂ H ₅ OH	0-100 % LEL
SC2-P3427-AX	Ethyl acetate	C ₄ H ₈ O ₂	0-100 % LEL
SC2-P3430-AX	Benzol, Benzene	C ₆ H ₆	0-100 % LEL
SC2-P3435-AX	Hexane	C ₆ H ₁₄	0-100 % LEL
SC2-P3448-AX	Butyl acetate	C ₆ H ₁₂ O ₂	0-100 % LEL
SC2-P3440-AX	Hydrogen	H ₂	0-100 % LEL
SC2-P3450-AX	Methanol	CH ₃ OH	0-100 % LEL
SC2-P3458-AX	MEK	C ₄ H ₈ O	0-100 % LEL
SC2-P3468-AX	Isobutyl alcohol	C ₄ H ₁₀ O	0-100 % LEL
SC2-P3460-AX	Butane	C ₄ H ₁₀	0-100 % LEL
SC2-P3470-AX	Octane	C ₈ H ₁₈	0-100 % LEL
SC2-P3472-AX	Cyclopentane	C ₅ H ₁₀	0-100 % LEL
SC2-P3473-AX	Methyl acetate	C ₃ H ₆ O ₂	0-100 % LEL
SC2-P3475-AX	Pentane	C ₅ H ₁₂	0-100 % LEL
SC2-P3480-AX	Propane	C ₃ H ₈	0-100 % LEL
SC2-P3480-BX	Propane	C ₃ H ₈	0-30 % LEL
SC2-P3480-CX	Propane	C ₃ H ₈	0-5000 ppm
SC2-P3482-AX	Isopropyl alcohol	C ₃ H ₈ O	0-100 % LEL
SC2-P3485-AX	Acetone	C ₃ H ₆ O	0-100 % LEL
SC2-P3490-AX	Toluene	C ₇ H ₈	0-100 % LEL
SC2-P3491-AX	Heptane	C ₇ H ₁₆	0-100 % LEL
SC2-P3494-AX	Butadiene	C ₄ H ₆	0-100 % LEL
SC2-P3495-AX	Nonane	C ₉ H ₂₀	0-100 % LEL
SC2-P3496-AX	Gasoline vapors		0-100 % LEL
Refrigerant Sensor			
SC2-S20XX-XX-AX	Freon	R134a, etc.	20-2000 ppm
Refrigerant Sensor in LEL range			
SC2-S2020-01-AX	Freon	R32	0-50 % LEL
SC2-S2020-02-AX	Freon	R455a	0-50 % LEL
SC2-S2020-03-AX	Freon	R454b	0-50 % LEL
SC2-S2020-04-AX	Freon	R1234yf	0-50 % LEL
SC2-S2020-05-AX	Freon	R1234ze	0-50 % LEL
Infrared Sensor			
SC2-I400-A-X	Methane	CH ₄	0-100 % LEL
SC2-I480-A-X	Propane	C ₃ H ₈	0-100 % LEL
	* On request		
	1) Liquid Petroleum Gases		

Analog Relay Board ARB2

Item No.	Description
STANDARD	
ARB2-N-20010	Analog Relay Board, N-housing, 24 V DC, sensor unit installed
OPTIONS	
ARB2-N-20000	Analog Relay Board 24 V
ARB2-A-XXXXX	A-Housing
ARB2-C-XXXXX	C-Housing
ARB2-E-XXXXX	E-Housing
ARB2-G-XXXXX	G-Housing
ARB2-N-XXXXX	N-Housing
ARB2-X-5XXXX	100-240 V AC
ARB2-X-X1XXX	With display
ARB2-X-XX1XX	Visual/audible indicator, mounted on the housing
ARB2-X-XXX2X	Accessory kit for remote sensor
ARB2-X-XXXXA	Version UL/CSA 61010-1 (not in N-housing)

Multi Sensor Board MSB2

Item No.	Description
STANDARD	
MSB2-A-230323000	Multi Sensor Board, A-Housing, 24 V
OPTIONS	
MSB2-0-XXXXXXXXXX	Without housing
MSB2-A-XXXXXXXXXX	A-Housing
MSB2-C-XXXXXXXXXX	C-Housing
MSB2-E-XXXXXXXXXX	E-Housing
MSB2-X-7XXXXXXXXXX	100-240 V AC / 24 V DC, 15 VA
MSB2-X-XX4XXXXXXXX	Visual/audible indicator, mounted on the housing
MSB2-X-XXX5XXXXXXXX	Analog output and RS-485 with Modbus protocol
MSB2-X-XXXXXX2XX	With display/keypad
MSB2-X-XXXXXXXXXA	Version UL/CSA 61010-1

Sensor Board SB2

Item No.	Description
STANDARD	
SB2-A-200200000	Sensor Board, A-Housing, 24 V DC, RS-485 with DGC-06 protocol
RB2-A-100000000	Remote Board for 1x SC2 for remote connection at the SB2, A-Housing
RB2-O-100000000	Remote Board for 1x SC2 for remote connection at the SB2, without housing
OPTIONS	
SB2-C-XXXXXXXXXX	C-Housing
SB2-X-XX3XXXXXX	Visual/audible indicator, mounted on the housing
SB2-X-XXX4XXXXX	RS-485 with Modbus protocol
SB2-X-XXX8XXXXX	MSR_D_Bus
SB2-X-XXXXXX2X0	With display/keypad
SB2-K-XXXXXXXXXX	ATEX housing
SB2-5-XXXXXXXXXX	Stainless steel housing
SB2-X-XXXXXXXXXA	Version UL/CSA 61010-1 (only housing type A & C)

Warning and Sensor Board WSB2

Item No.	Description
STANDARD	
WSB2-A-220311000	Warning and Sensor Board WSB2, A-Housing, 2 relays
WSB2-A-200311000	Warning and Sensor Board WSB2, A-Housing, without alarm relay/fault signal relay
OPTIONS	
WSB2-C-XXXXXXXXXX	C-Housing
WSB2-E-XXXXXXXXXX	E-Housing
WSB2-N-XXXXXXXXXX	N-Housing
WSB2-X-7XXXXXXXXXX	100-240 V / 15 VA / 24 V
WSB2-X-XX3XXXXXX	Visual/audible indicator, mounted on the housing
WSB2-X-XXX2XXXX	1x digital input with acknowledgement button on the housing
WSB2-X-XXX3XXXX	1x analog output and RS-485 with DGC-06 and Modbus protocol
WSB2-X-XXX4XXXX	Only RS-485 with DGC-06 and Modbus protocol
WSB2-X-XXXXX2XX	With display/keypad
WSB2-X-XXXXXX1X	3x SC2 mounting slot
WSB2-X-XXXXXX2X	2x SC2 mounting slot and remote input terminal
WSB2-X-XXXXXX3X	2x SC2 mounting slot for same gas type and remote input terminal
WSB2-X-XXXXXX5X	1x SSAX1 mounting slot (for ATEX compliant sensor)
WSB2-X-XXXXXXXXXA	Version UL/CSA 61010-1 (housings A, C, E)

Multi Sensor Controller MSC2

Item No.	Description
STANDARD	
MSC2-C-230322000	Multi Sensor Controller, 24 V, C-Housing, 24 V
MSC2-C-530322000	Multi Sensor Controller, C-Housing, 230 V, 5 VA
MSC2-C-230322200	Multi Sensor Controller, C-Housing, 12V / 24 V, with display/keypad
MSC2-C-530322200	Multi Sensor Controller, C-Housing, 230 V, 5 VA, with display/keypad
OPTIONS	
MSC2-A-XXXXXXXXXX	A-Housing
MSC2-C-XXXXXXXXXX	C-Housing
MSC2-E-XXXXXXXXXX	E-Housing
MSC2-E-7XXXXXXXXXX	100-240 V AC / 24 V DC, 15 VA
MSC2-E-9XXXXXXXXXX	UPS 100-240 V AC / 24 V DC, 15VA, 0.8 Ah
MSC2-X-XX4XXXXXXXX	Visual/audible indicator, mounted on the housing
MSC2-X-XX5XXXXXXXX	1x analog output and RS-485 with Modbus protocol
MSC2-X-XXX4XXXXXX	1x digital input and 1x acknowledgement button on the housing
MSC2-X-XXXXXX2XX	With display/keypad
MSC2-X-XXXXXXXXXA	Version UL/CSA 61010-1 (only housing types A, C, E)

Compactcontroller

Item No.	Description
STANDARD	
MSC2-C-23032020K	Compactcontroller, C-Housing, 24 V DC, with display/keypad
MSC2-C-23032020C	Compactcontroller, C-Housing, 24 V DC, with display/keypad, version UL/CSA 61010-1
OPTIONS	
MSC2-C-XXXXXXXXXX	C-Housing
MSC2-E-XXXXXXXXXX	E-Housing
MSC2-E-7XXXXXXXXXX	100-240 V AC / 24 V DC, 15 VA
MSC2-E-9XXXXXXXXXX	UPS 100-240 V AC / 24 V DC, 15VA, 0.8 Ah
MSC2-X-XX4XXXXXX	Visual/audible indicator, mounted on the housing
MSC2-X-XXXXXXXXXA	Version UL/CSA 61010-1 (housing types A, C, E)

Multi Gas Controller MGC2

Item No.	Description
STANDARD	
MGC2-C-230323000	Multi Gas Controller, C-Housing, 24 V
MGC2-C-530323000	Multi Gas Controller, C-Housing, 230 V-5 VA
MGC2-C-230323200	Multi Gas Controller, C-Housing, 24 V, with display/keypad
MGC2-C-530323200	Multi Gas Controller, C-Housing, 230 V, 5 VA, with display/keypad
OPTIONS	
MGC2-A-XXXXXXXXXX	A-Housing
MGC2-C-XXXXXXXXXX	C-Housing
MGC2-E-XXXXXXXXXX	E-Housing
MGC2-X-7XXXXXXXXXX	100-240 V AC / 24 V DC, 15 VA
MGC2-X-9XXXXXXXXXX	UPS 100-240 V AC / 24 V DC, 15 VA, 0.8 Ah
MGC2-X-XX4XXXXXXXX	Visual/audible indicator, mounted on the housing
MGC2-X-XXX5XXXXXX	1x analog output and RS-485 with Modbus protocol
MGC2-X-XXXX4XXXXX	1x digital input and acknowledgement button on the housing

Door Entrance Module DEM-06

Item No.	Description
DEM-06-C-S100	Door Entrance Module, slave version, internal buzzer & 1x open collector output
OPTIONS	
DEM-06-A-XXXX	A-Housing
DEM-06-X-S200	2x open collector output with reset input
DEM-06-X-S300	Mounting together in the MSB2-Housing

Digital Gas Controller DGC-06

Item No.	Description
STANDARD	
DGC-06-2-0-1-010000000	Power supply unit: 230/110 V AC <-> 24 V DC, 6.5 Ah, 4 relays, 1-row housing
DGC-06-2-0-2-010000000	Power unit: 230/110 V AC <-> 24 V DC, 6.5 Ah, 4 relays, 2-row housing
DGC-06-2-0-3-010000000	Power unit: 230/110 V AC <-> 24 V DC, 6.5 Ah, 4 relays, 3-row housing
DGC-06-2-0-4-010000000	Power unit: 230/110 V AC <-> 24 V DC, 6.5 Ah, 4 relays, 4-row housing
DGC-06-3-0-X-XXXXXXXXXX	UPS: 230/110 V AC <-> 24 V DC, 2.2 Ah
DGC-06-4-0-X-XXXXXXXXXX	UPS: 230/110 V AC <-> 24 V DC, 6.5 Ah
DGC-06-0-0-X-XXXXXXXXXX	Supply 24 V DC
OPTIONS	
DGC-06-2-0-1-XXX1XXXXX	Interface Modbus RTU RS-485
DGC-06-2-0-1-XX1XXXXXX	Data Logger incl. USB flash drive
DGC-06-2-0-1-XXXXX1XXX	Control of external warning devices
DGC-06-X-X-X-XXXXXX1XX	Cable entry from below
DGC-06-X-X-X-XXXXXX2XX	Cable entry from below and above
DGC-06-X-X-X-XXXXXXX1X	Lockable housing
DGC-06-2-0-1-1XXXXXXX	Power failure flashing light

Gas Controller Module GC-06

Item No.	Description
GC-06-000000-XX	Gas Controller Module
GC-06-X2XXXX-XX	Door mounting with mounting panel
GC-06-1XXXXX-XX	Power failure flashing light
EP-06-X00	Extension module

PolyGard[®]2 Control Box and Tools

Item No.	Description
PGCB	
PGCB-GC06-07-0	PolyGard [®] Control Box, 7" Touchscreen, without power supply, without housing
PGCB-GC06-07-A	PolyGard [®] Control Box, 7" Touchscreen, with power supply and housing
STL06 - Service Tool	
STL06-PGX2-P7	Partner tool for display, calibration, addressing and parameter changes
STL06-PGX2-A7	System tool for display, calibration, addressing and parameter changes *
STL06-MC2-A1	Tool for the product line μ Gard2 (MC2) for display and calibration
PCE06 - EasyConfig	
PCE06-PGX2-PF	Partner tool for display, calibration, addressing, parameter changes and history
PCE06-PGX2-AF	System tool for display, calibration, addressing, parameter changes and history *
* Is ordered by the partner for end customers	

Warning Devices

Item No.	Description
BL-24	Flash light
WH-24	Warning horn, 24 V DC
WH-230	Warning horn, 230 V AC
WH/BL-24	Warning horn/flashing light combination, 24 V DC
WH/BL-24-Tast	Warning horn/flashing light combination, 24 V DC + button
WH/BL-230	Warning horn/flashing light combination, 230 V AC
WT-D3-30-222-GW	LED warning sign D3 – EN 50545
WT-G1-30-111-RW	LED warning sign G1 – VDI 2053 GAS ALARM
WT-A1-30-127-RR	LED warning sign A1 – standard Austria
WT-A2-30-214-RR	LED warning sign A2 – standard Austria
WT-A3-30-122-RR	LED warning sign A3 – standard Austria
WT-ES-Version	LED warning sign (Extended Safety)
OPTIONS	
WT-XX-XX-XXX-XX	Warning sign in IP54
WT-ST-XX-XXX-XX	Special labelling
WT-XX-31-XXX-XX	Power supply 24 V AC/DC, with horn
WT-XX-40-XXX-XX	Power supply 230 V AC
WT-XX-41-XXX-XX	Power supply 230 V AC, with horn

Accessories

Item No.	Description
ADAPTER	
STA06-MC2	Converter for PCE06-PGX2 tool for communication with the MC2 line
ACCESSORIES	
C2-Z2	Duct mounting set
C2-Z4	Calibration adapter for MC2, SC2 (plastic sleeve without lateral gas inlet)
C2-Z6	Calibration adapter MC2, SC2 (plastic sleeve with lateral gas inlet)
C2-Z5	SplashGuard
SP6-00	Sensor protection / guard rail, stainless steel, 6 mm
OT-01	Tool for opening the stainless steel housing

Extended Safety

Item No.	Description
MSB2-ES	Sensor Board line MSB2-ES
EP-06-ES_MOT	Motor module
EP-06-ES_MCM	System module
GC-06-ES	Gas controller
EP-06-ES_FCM	Fire control module
EP-06-ES_FDM	Fire detection module

Intelligent Parking Guidance Systems

Item No.	Description
PC SYSTEMS	
PC	Server interface > 500 sensors
PC-Comfort-1	Server for small systems incl. 3 RS-485 ports < 500 sensors
T-Box-Ethernet	Modbus - TCP/IP converter for virtual machines
PC SOFTWARE	
PG-CC	ParkGard® control center - SCADA software
SENSORS	
PU-02-2	Ultrasonic indoor sensor (design)
PU-02-4	Ultrasonic indoor sensor (cross)
PU-02-PK	USS with pot. free contact
PU-02-5	Status LED parking space indicator, with extension
PU-02-8	Status LED parking space indicator, in plastic housing
PU-02-3	Ultrasonic indoor counting sensor, 1.900 x 65 x 90 mm (L x W x D)
CONTROLLER	
PCL-MU-1	MSR level controller 1, can control up to 32 ultrasonic sensors
PCL-MU-2	MSR level controller 2, can control up to 64 ultrasonic sensors
PCL-MU-3	MSR level controller 3, can control up to 96 ultrasonic sensors
PCL-MU-4	MSR level controller 4, can control up to 128 ultrasonic sensors
DISPLAYS	
ParkGard® centi	LED display 2-row, 5x1 digit, 450 x 450 x 32 mm
ParkGard® milli	LED display 1-row, 1x4 digit, 560 x 269 x 32 mm
ParkGard® micro	LED display 1-row, 1x3 digit, 450 x 269 x 32 mm
ParkGard® nano	LED display 1-row, 1x2 digit, 340 x 269 x 32 mm
ParkGard® pico	LED arrow, green, IP 43, 269 x 269 x 32 mm
ParkGard® micro-o	LED display 1 row, 1x3 digit, 374 x 249 x 185 mm
Display EXIT	1-row, 642 x 203 x 22 mm, aluminium
ParkGard® LED - Matrix-I	Freely programmable matrix LED display indoor IP45
ParkGard® LED - Matrix-O	Freely programmable matrix LED display outdoor IP54



Sensor PolyXeta® 2

Toxic Gases for Zone 1 and Zone 2

Item No.	Item No.	Gas	Measuring Range
Zone 1	Zone 2		
EL. Chem. Sensor	EL. Chem. Sensor		
PX2-1-X-E1110-BX	PX2-2-X-E1110-BX	Carbon monoxide CO	0-100 ppm
PX2-1-X-E1110-CX	PX2-2-X-E1110-CX	Carbon monoxide CO	0-150 ppm
PX2-1-X-E1110-EX	PX2-2-X-E1110-EX	Carbon monoxide CO	0-250 ppm
PX2-1-X-E1110-FX	PX2-2-X-E1110-FX	Carbon monoxide CO	0-300 ppm
PX2-1-X-E1110-HX	PX2-2-X-E1110-HX	Carbon monoxide CO	0-500 ppm
PX2-1-X-E1125-AX	PX2-2-X-E1125-AX	Ammonia* NH3	0-100 ppm
PX2-1-X-E1125-BX	PX2-2-X-E1125-BX	Ammonia* NH3	0-300 ppm
PX2-1-X-E1125-CX	PX2-2-X-E1125-CX	Ammonia* NH3	0-500 ppm
PX2-1-X-E1125-DX	PX2-2-X-E1125-DX	Ammonia* NH3	0-1000 ppm
PX2-1-X-E1125-EX	PX2-2-X-E1125-EX	Ammonia* NH3	0-5000 ppm
PX2-1-X-E1130-EX	PX2-2-X-E1130-EX	Nitrogen dioxide NO2	0-100 ppm
PX2-1-X-E1183-BX	PX2-2-X-E1183-BX	Hydrogen cyanide HCN	0-50 ppm
PX2-1-X-E1183-CX	PX2-2-X-E1183-CX	Hydrogen cyanide HCN	0-100 ppm
PX2-1-X-E1186-DX	PX2-2-X-E1186-DX	Hydrogen chloride HCl	0-20 ppm
PX2-1-X-E1195-A2	PX2-2-X-E1195-A2	Oxygen, 2 years O2	0-25 % Vol
PX2-1-X-E1195-A3	PX2-2-X-E1195-A3	Oxygen, 3 years O2	0-25 % Vol
PX2-1-X-E1195-A5	PX2-2-X-E1195-A5	Oxygen, 5 years O2	0-25 % Vol
PX2-1-X-E1195-A7	PX2-2-X-E1195-A7	Oxygen, 7 years O2	0-25 % Vol
PX2-1-X-E1197-AX	PX2-2-X-E1197-AX	Hydrogen sulphide H2S	0-50 ppm
PX2-1-X-E1197-BX	PX2-2-X-E1197-BX	Hydrogen sulphide H2S	0-100 ppm
PX2-1-X-E1197-CX	PX2-2-X-E1197-CX	Hydrogen sulphide H2S	0-200 ppm
PX2-1-X-E1197-DX	PX2-2-X-E1197-DX	Hydrogen sulphide H2S	0-300 ppm
Infrared Sensor	Infrared Sensor		
PX2-2-X-I464-BX	PX2-2-X-I464-BX	Carbon dioxide CO2	0-5 % Vol
PX2-2-X-I464-DX	PX2-2-X-I464-DX	Carbon dioxide CO2	0-5000 ppm
PX2-2-X-I400-AX	PX2-2-X-I400-AX	Methane CH4	0-100 % LEL
PX2-2-X-I480-AX	PX2-2-X-I480-AX	Propane C3H8	0-100 % LEL

* On request

Sensor PolyXeta[®]2

Combustible Gases and Freon for Zone 1 and Zone 2

Item No.	Item No.	Gas	Measuring Range
Zone 1	Zone 2		
Pellistor Sensor	Pellistor Sensor		
PX2-1-X-P3400-AX	PX2-2-X-P3400-AX	Methane	CH ₄ 0-100 % LEL
PX2-1-X-P3402-AX	PX2-2-X-P3402-AX	LPG ¹⁾	LPG 0-100 % LEL
PX2-1-X-P3408-AX	PX2-2-X-P3408-AX	Ammonia *	NH ₃ 0-100 % LEL
PX2-1-X-P3410-AX	PX2-2-X-P3410-AX	Ethylene	C ₂ H ₄ 0-100 % LEL
PX2-1-X-P3415-AX	PX2-2-X-P3415-AX	Cyclohexane, Hexane	C ₆ H ₁₂ 0-100 % LEL
PX2-1-X-P3420-AX	PX2-2-X-P3420-AX	Ethane, R170	C ₂ H ₆ 0-100 % LEL
PX2-1-X-P3425-AX	PX2-2-X-P3425-AX	Ethanol	C ₂ H ₅ OH 0-100 % LEL
PX2-1-X-P3427-AX	PX2-2-X-P3427-AX	Ethyl acetate	C ₄ H ₈ O ₂ 0-100 % LEL
PX2-1-X-P3430-AX	PX2-2-X-P3430-AX	Benzol, Benzene	C ₆ H ₆ 0-100 % LEL
PX2-1-X-P3435-AX	PX2-2-X-P3435-AX	Hexane	C ₆ H ₁₄ 0-100 % LEL
PX2-1-X-P3440-AX	PX2-2-X-P3440-AX	Hydrogen	H ₂ 0-100 % LEL
PX2-1-X-P3448-AX	PX2-2-X-P3448-AX	Butyl acetate	C ₆ H ₁₂ O ₂ 0-100 % LEL
PX2-1-X-P3450-AX	PX2-2-X-P3450-AX	Methanol	CH ₃ OH 0-100 % LEL
PX2-1-X-P3458-AX	PX2-2-X-P3458-AX	MEK	C ₄ H ₈ O 0-100 % LEL
PX2-1-X-P3460-AX	PX2-2-X-P3460-AX	Butane	C ₄ H ₁₀ 0-100 % LEL
PX2-1-X-P3468-AX	PX2-2-X-P3468-AX	Isobutyl alcohol	C ₄ H ₁₀ O 0-100 % LEL
PX2-1-X-P3470-AX	PX2-2-X-P3470-AX	Octane	C ₈ H ₁₈ 0-100 % LEL
PX2-1-X-P3472-AX	PX2-2-X-P3472-AX	Cyclopentane	C ₅ H ₁₀ 0-100 % LEL
PX2-1-X-P3473-AX	PX2-2-X-P3473-AX	Methyl acetate	C ₃ H ₆ O ₂ 0-100 % LEL
PX2-1-X-P3475-AX	PX2-2-X-P3475-AX	Pentane	C ₅ H ₁₂ 0-100 % LEL
PX2-1-X-P3480-AX	PX2-2-X-P3480-AX	Propane	C ₃ H ₈ 0-100 % LEL
PX2-1-X-P3480-BX	PX2-2-X-P3480-BX	Propane	C ₃ H ₈ 0-30 % LEL
PX2-1-X-P3480-CX	PX2-2-X-P3480-CX	Propane	C ₃ H ₈ 0-5000 ppm
PX2-1-X-P3482-AX	PX2-2-X-P3482-AX	Isopropyl alcohol	C ₃ H ₈ O 0-100 % LEL
PX2-1-X-P3485-AX	PX2-2-X-P3485-AX	Acetone	C ₃ H ₆ O 0-100 % LEL
PX2-1-X-P3490-AX	PX2-2-X-P3490-AX	Toluene	C ₇ H ₈ 0-100 % LEL
PX2-1-X-P3491-AX	PX2-2-X-P3491-AX	Heptane	C ₇ H ₁₆ 0-100 % LEL
PX2-1-X-P3494-AX	PX2-2-X-P3494-AX	Butadiene	C ₄ H ₆ 0-100 % LEL
PX2-1-X-P3495-AX	PX2-2-X-P3495-AX	Nonane	C ₉ H ₂₀ 0-100 % LEL
PX2-1-X-P3496-AX	PX2-2-X-P3496-AX	Petrol vapors	0-100 % LEL
Refrigerant Sensor	Refrigerant Sensor		
PX2-1-X-S20XX-XX-X	PX2-2-X-S20XX-XX-X	Freon	R134a, etc. 20-2000 ppm
Infrared Sensor	Infrared Sensor		
PX2-1-X-S400-AX	PX2-2-X-S400-AX	Methane	CH ₄ 0-100 % LEL
PX2-1-X-S480-AX	PX2-2-X-S480-AX	Propane	C ₃ H ₈ 0-100 % LEL

* On request

1) Liquid Petroleum Gases

Sensor Cartridge SX1

Toxic Gases for Zone 1 and Zone 2

Item No.	Gas		Measuring Range
EL. Chem. Sensor			
SX1-1-E1110-BX	Carbon monoxide	CO	0-100 ppm
SX1-1-E1110-CX	Carbon monoxide	CO	0-150 ppm
SX1-1-E1110-EX	Carbon monoxide	CO	0-250 ppm
SX1-1-E1110-FX	Carbon monoxide	CO	0-300 ppm
SX1-1-E1110-HX	Carbon monoxide	CO	0-500 ppm
SX1-1-E1125-AX	Ammonia *	NH ₃	0-100 ppm
SX1-1-E1125-BX	Ammonia *	NH ₃	0-300 ppm
SX1-1-E1125-CX	Ammonia *	NH ₃	0-500 ppm
SX1-1-E1125-DX	Ammonia *	NH ₃	0-1000 ppm
SX1-1-E1125-EX	Ammonia *	NH ₃	0-5000 ppm
SX1-1-E1130-BX	Nitrogen dioxide	NO ₂	0-100 ppm
SX1-1-E1183-BX	Hydrogen cyanide	HCN	0-50 ppm
SX1-1-E1183-CX	Hydrogen cyanide	HCN	0-100 ppm
SX1-1-E1186-DX	Hydrogen chloride	HCl	0-20 ppm
SX1-1-E1195-A2	Oxygen, 2 years	O ₂	0-25 % Vol
SX1-1-E1195-A3	Oxygen, 3 years	O ₂	0-25 % Vol
SX1-1-E1195-A5	Oxygen, 5 years	O ₂	0-25 % Vol
SX1-1-E1195-A7	Oxygen, 7 years	O ₂	0-25 % Vol
SX1-1-E1197-AX	Hydrogen sulphide	H ₂ S	0-50 ppm
SX1-1-E1197-BX	Hydrogen sulphide	H ₂ S	0-100 ppm
SX1-1-E1197-CX	Hydrogen sulphide	H ₂ S	0-200 ppm
SX1-1-E1197-DX	Hydrogen sulphide	H ₂ S	0-500 ppm
Infrared Sensor			
SX1-I464-BX	Carbon dioxide	CO ₂	0-5 % Vol
SX1-I464-DX	Carbon dioxide	CO ₂	0-5000 ppm
SX1-I400-AX	Methane	CH ₄	0-100 % LEL
SX1-I480-AX	Propane	C ₃ H ₈	0-100 % LEL
* On request			

Sensor Cartridge SX1

Combustible Gases and Freon for Zone 1 and Zone 2

Item No.	Gas	Measuring Range
Pellistor Sensor		
SX1-1-P3400-AX	Methane CH ₄	0-100 % LEL
SX1-1-P3402-AX	LPG ¹⁾ LPG	0-100 % LEL
SX1-1-P3408-AX	Ammonia * NH ₃	0-100 % LEL
SX1-1-P3410-AX	Ethylene C ₂ H ₄	0-100 % LEL
SX1-1-P3415-AX	Cyclohexane, Hexane C ₆ H ₁₂	0-100 % LEL
SX1-1-P3420-AX	Ethane, R170 C ₂ H ₆	0-100 % LEL
SX1-1-P3425-AX	Ethanol C ₂ H ₅ OH	0-100 % LEL
SX1-1-P3427-AX	Ethyl acetate C ₄ H ₈ O ₂	0-100 % LEL
SX1-1-P3430-AX	Benzol, Benzene C ₆ H ₆	0-100 % LEL
SX1-1-P3435-AX	Hexane C ₆ H ₁₄	0-100 % LEL
SX1-1-P3440-AX	Hydrogen H ₂	0-100 % LEL
SX1-1-P3448-AX	Butyl acetate C ₆ H ₁₂ O ₂	0-100 % LEL
SX1-1-P3450-AX	Methanol CH ₃ OH	0-100 % LEL
SX1-1-P3458-AX	MEK C ₄ H ₈ O	0-100 % LEL
SX1-1-P3460-AX	Butane C ₄ H ₁₀	0-100 % LEL
SX1-1-P3468-AX	Isobutyl alcohol C ₄ H ₁₀ O	0-100 % LEL
SX1-1-P3470-AX	Octane C ₈ H ₁₈	0-100 % LEL
SX1-1-P3472-AX	Cyclopentane C ₅ H ₁₀	0-100 % LEL
SX1-1-P3473-AX	Methyl acetate C ₃ H ₆ O ₂	0-100 % LEL
SX1-1-P3475-AX	Pentane C ₅ H ₁₂	0-100 % LEL
SX1-1-P3480-AX	Propane C ₃ H ₈	0-100 % LEL
SX1-1-P3480-BX	Propane C ₃ H ₈	0-30 % LEL
SX1-1-P3480-CX	Propane C ₃ H ₈	0-5000 ppm
SX1-1-P3482-AX	Isopropyl alcohol C ₃ H ₈ O	0-100 % LEL
SX1-1-P3485-AX	Acetone C ₃ H ₆ O	0-100 % LEL
SX1-1-P3490-AX	Toluene C ₇ H ₈	0-100 % LEL
SX1-1-P3491-AX	Heptane C ₇ H ₁₆	0-100 % LEL
SX1-1-P3494-AX	Butadiene C ₄ H ₆	0-100 % LEL
SX1-1-P3495-AX	Nonane C ₉ H ₂₀	0-100 % LEL
SX1-1-P3496-AX	Petrol vapors	0-100 % LEL
Refrigerant Sensor		
SX1-S20XX-XX-X	Freon R134a, etc.	20-2000 ppm
Infrared Sensor		
SX1-I400-AX	Methane CH ₄	0-100 % LEL
SX1-I480-AX	Propane C ₃ H ₈	0-100 % LEL

* On request
1) Liquid Petroleum Gases

Sensor Cartridge SSAX1

Toxic Gases for Zone 1 and Zone 2

Item No.	Gas		Measuring Range
EL. Chem. Sensor			
SSAX1-1-E1110-BX	Carbon monoxide	CO	0-100 ppm
SSAX1-1-E1110-CX	Carbon monoxide	CO	0-150 ppm
SSAX1-1-E1110-EX	Carbon monoxide	CO	0-250 ppm
SSAX1-1-E1110-FX	Carbon monoxide	CO	0-300 ppm
SSAX1-1-E1110-HX	Carbon monoxide	CO	0-500 ppm
SSAX1-1-E1125-AX	Ammonia *	NH ₃	0-100 ppm
SSAX1-1-E1125-BX	Ammonia *	NH ₃	0-300 ppm
SSAX1-1-E1125-CX	Ammonia *	NH ₃	0-500 ppm
SSAX1-1-E1125-DX	Ammonia *	NH ₃	0-1000 ppm
SSAX1-1-E1125-EX	Ammonia *	NH ₃	0-5000 ppm
SSAX1-1-E1130-BX	Nitrogen dioxide	NO ₂	0-100 ppm
SSAX1-1-E1183-BX	Hydrogen cyanide	HCN	0-50 ppm
SSAX1-1-E1183-CX	Hydrogen cyanide	HCN	0-100 ppm
SSAX1-1-E1186-DX	Hydrogen chloride	HCl	0-20 ppm
SSAX1-1-E1195-A2	Oxygen, 2 years	O ₂	0-25 % Vol
SSAX1-1-E1195-A3	Oxygen, 3 years	O ₂	0-25 % Vol
SSAX1-1-E1195-A5	Oxygen, 5 years	O ₂	0-25 % Vol
SSAX1-1-E1195-A7	Oxygen, 7 years	O ₂	0-25 % Vol
SSAX1-1-E1197-AX	Hydrogen sulphide	H ₂ S	0-50 ppm
SSAX1-1-E1197-BX	Hydrogen sulphide	H ₂ S	0-100 ppm
SSAX1-1-E1197-CX	Hydrogen sulphide	H ₂ S	0-200 ppm
SSAX1-1-E1197-DX	Hydrogen sulphide	H ₂ S	0-500 ppm
Infrared Sensor			
SSAX1-1-S400-AX	Methane	CH ₄	0-100 % LEL
SSAX1-1-S480-AX	Propane	C ₃ H ₈	0-100 % LEL
Premium			
SSAX1-1-I400-AX	Methane	CH ₄	0-100 % LEL
SSAX1-1-I400-BX	Methane	CH ₄	0-100 % Vol
SSAX1-1-I480-AX	Propane	C ₃ H ₈	0-100 % LEL
SSAX1-1-I464-BX	Carbon dioxide	CO ₂	0-5 % Vol
SSAX1-1-I464-DX	Carbon dioxide	CO ₂	0-5000 ppm
SSAX1-1-I464-FX	Carbon dioxide	CO ₂	0-10 % Vol

* On request

Sensor Cartridge SSAX1

Combustible Gases for Zone 1 and Zone 2

Item No.	Gas	Measuring Range
Pellistor Sensor		
SSAX1-1-P3400-AX	Methane	CH ₄ 0-100 % LEL
SSAX1-1-P3402-AX	LPG ¹⁾	LPG 0-100 % LEL
SSAX1-1-P3408-AX	Ammonia *	NH ₃ 0-100 % LEL
SSAX1-1-P3410-AX	Ethylene	C ₂ H ₄ 0-100 % LEL
SSAX1-1-P3415-AX	Cyclohexane, Hexane	C ₆ H ₁₂ 0-100 % LEL
SSAX1-1-P3420-AX	Ethane, R170	C ₂ H ₆ 0-100 % LEL
SSAX1-1-P3425-AX	Ethanol	C ₂ H ₅ OH 0-100 % LEL
SSAX1-1-P3427-AX	Ethyl acetate	C ₄ H ₈ O ₂ 0-100 % LEL
SSAX1-1-P3430-AX	Benzol, Benzene	C ₆ H ₆ 0-100 % LEL
SSAX1-1-P3435-AX	Hexane	C ₆ H ₁₄ 0-100 % LEL
SSAX1-1-P3440-AX	Hydrogen	H ₂ 0-100 % LEL
SSAX1-1-P3448-AX	Butyl acetate	C ₆ H ₁₂ O ₂ 0-100 % LEL
SSAX1-1-P3450-AX	Methanol	CH ₃ OH 0-100 % LEL
SSAX1-1-P3458-AX	MEK	C ₄ H ₈ O 0-100 % LEL
SSAX1-1-P3460-AX	Butane	C ₄ H ₁₀ 0-100 % LEL
SSAX1-1-P3468-AX	Isobutyl alcohol	C ₄ H ₁₀ O 0-100 % LEL
SSAX1-1-P3470-AX	Octane	C ₈ H ₁₈ 0-100 % LEL
SSAX1-1-P3472-AX	Cyclopentane	C ₅ H ₁₀ 0-100 % LEL
SSAX1-1-P3473-AX	Methyl acetate	C ₃ H ₆ O ₂ 0-100 % LEL
SSAX1-1-P3475-AX	Pentane	C ₅ H ₁₂ 0-100 % LEL
SSAX1-1-P3480-AX	Propane	C ₃ H ₈ 0-100 % LEL
SSAX1-1-P3480-BX	Propane	C ₃ H ₈ 0-30 % LEL
SSAX1-1-P3480-CX	Propane	C ₃ H ₈ 0-5000 ppm
SSAX1-1-P3482-AX	Isopropyl alcohol	C ₃ H ₈ O 0-100 % LEL
SSAX1-1-P3485-AX	Acetone	C ₃ H ₆ O 0-100 % LEL
SSAX1-1-P3490-AX	Toluene	C ₇ H ₈ 0-100 % LEL
SSAX1-1-P3491-AX	Heptane	C ₇ H ₁₆ 0-100 % LEL
SSAX1-1-P3494-AX	Butadiene	C ₄ H ₆ 0-100 % LEL
SSAX1-1-P3495-AX	Nonane	C ₉ H ₂₀ 0-100 % LEL
SSAX1-1-P3496-AX	Petrol vapors	0-100 % LEL
	* On request	
	1) Liquid Petroleum Gases	

PolyXeta[®] 2 Modules

Item No.	Description
MODULES	
GC-06-XXXXXX-XX	Gas Controller Module
EP-06-X00	Extension module addresses 1-7, incl. repeater
OPTIONS	
GC-06-1XXXXX-XX	Power failure flashing light
GC-06-XX1XXX-XX	Data logger incl. USB flash drive
GC-06-XXX1XX-XX	Interface Modbus RTU RS-485
STL06 - SERVICE TOOL	
STL06-PGX2-P7	Partner tool for display, calibration, addressing and parameter changes
STL06-PGX2-A7	System tool for display, calibration, addressing and parameter changes *
PCE06 - EASYCONFIG	
PCE06-PGX2-PF	Partner tool for display, calibration, addressing, parameter changes and history
PCE06-PGX2-AF	System tool for display, calibration, addressing, parameter changes and history *

* Ordered by partner for end customers

Accessories

Item No.	Description
ADAPTER	
STA06-PX2	Adapter for STL06-PGX2 and PCE06-PGX2 tool for communication with product line PX2
ACCESSORIES	
Cal01-PX2	Calibration adapter for PX2 sensors
MSR_Pen_PX2	Magnetic pen for configuration of the PX2 on the display
SG-PX2	SplashGuard for PX2 sensors
CABLE GLAND	
ZU-PX2-CG-SN	Metal ATEX cable gland for zone 1 & 2
ZU-PX2-CG-PL	Plastic ATEX cable gland for zone 2
MOUNTING KIT	
Mounting-Kit	Mounting kit for SSAX1 sensors & SC2 sensor cartridges in stainless steel housing

Warning Devices

for ATEX Zone 1 and 2

Item No.	Description
BL-X	Flashing light
WH-24-X	Warning horn, 24 V DC, zone 1 & 2
WH-230-X	Warning horn, 230 V AC, zone 1 & 2
WH/BL 24-X	Warning horn/flashing light combination, 24 V DC
WH/BL 230-X	Warning horn/flashing light combination, 230 V AC

PolyMarine Products

For combustible and toxic gases

Item No.	Description
CONTROLLER	
MGC2-C-13132300	Multi Gas Controller with attached warning device (buzzer, status-LED, 12 V, reset button and 5 m cable), surface mounting
MGC2-Q-XXXXXXXX	Separate display with reset button, 15 m cable, for installation
SENSORS	
MC2-0-E1110-F-0	Carbon monoxide (CO), 0-300 ppm, for installation
MC2-0-P3496-A-0	Petrol vapors, 0-100 % LEL, for installation
MC2-0-P3480-A-0	Propane (C ₃ H ₈), 0-100 % LEL, for installation
OPTIONS	
MC2-A-XXXXX-X-X	A-Housing for surface mounting
MC2-R-XXXXX-X-X	R-Housing for flush mounting
ACCESSORIES	
WH-BL-24-TAST	Warning horn/flashing light combination, 12 V / 24 V, button
RMS-PM-001	Smoke detector, 12 V / 24 V, digital output
VAR-PM-001	Magnetic valve, IP65, ATEX, normally open, manual reset
M-CAB-PMGC-S	Cable for connecting the sensors (if not directly in the housing of the PMGC)

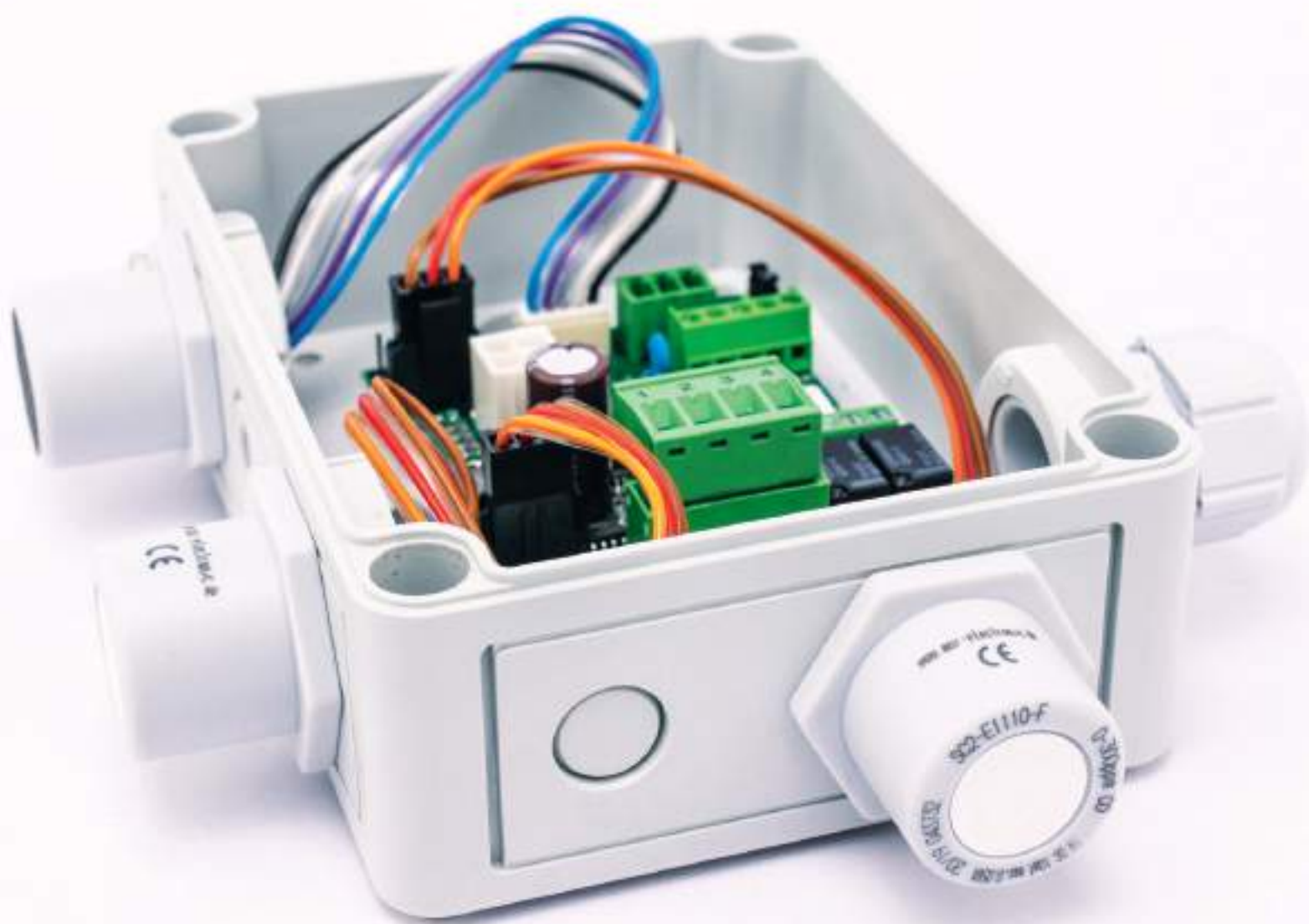

Housings

Boards

W x H x D

5 = Stainless steel:

113 x 135 x 45 mm



A = Plastic:

94 x 130 x 57 mm

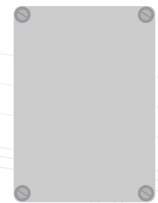

C = Plastic:

130 x 130 x 75 mm

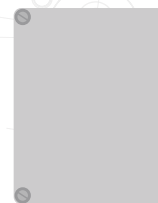

D = Plastic:

94 x 65 x 57 mm



E = Plastic:

130 x 130 x 99 mm

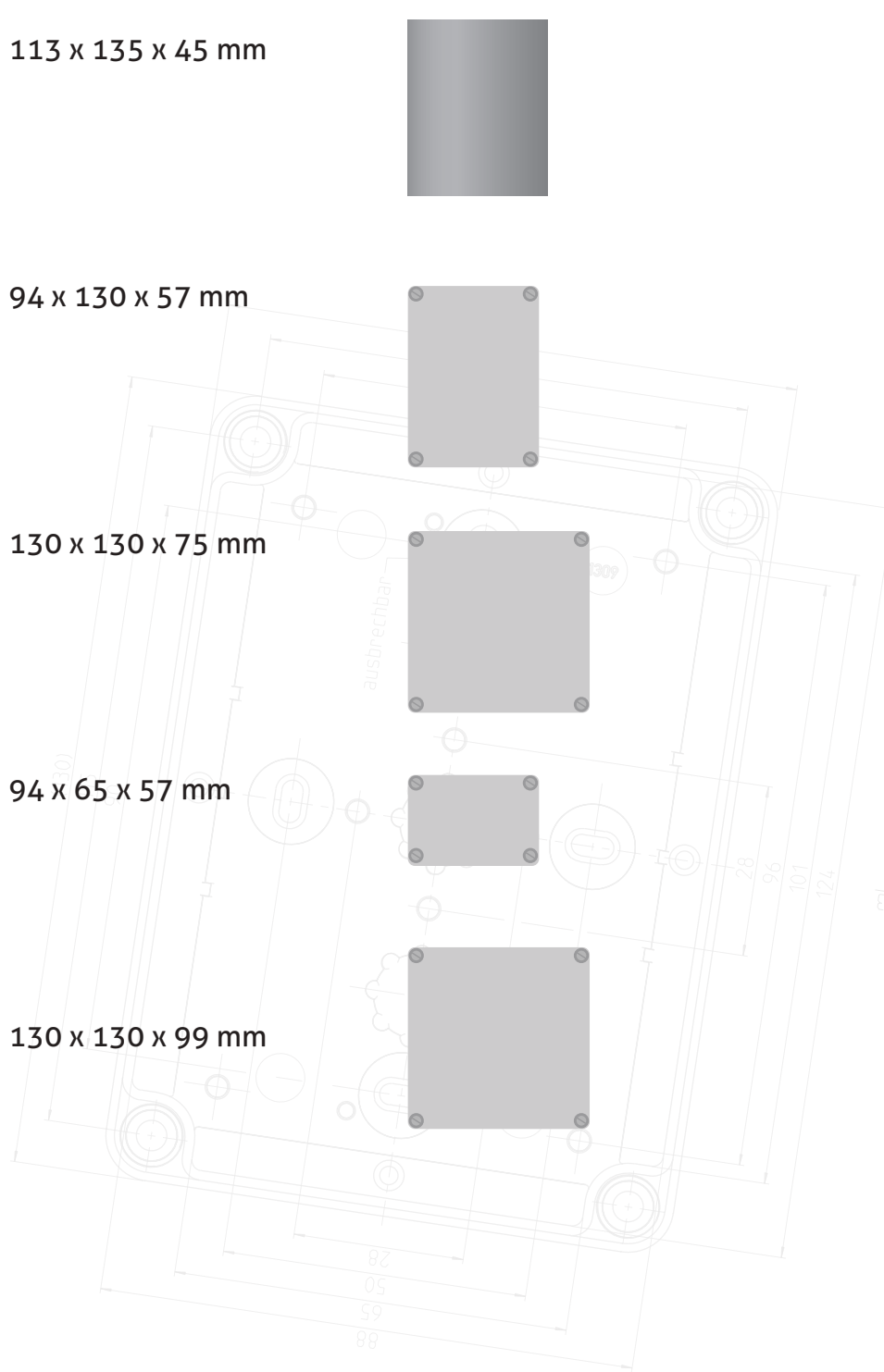

Images similar, not to scale

F = Plastic round:

Ø 87 x 45 mm



G = Plastic:

94 x 130 x 81 mm

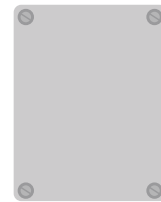

K = Die-cast aluminum (PX2):

Ø 95 x 82 mm

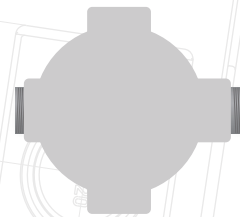

N = Plastic:

80 x 82 x 53 mm

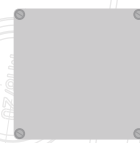

P = Plastic:

Door installation housing
150 x 96 x 50 mm

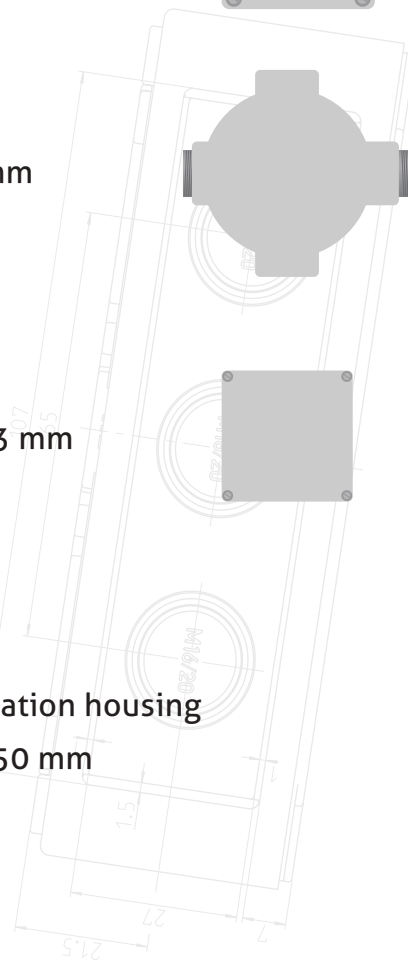
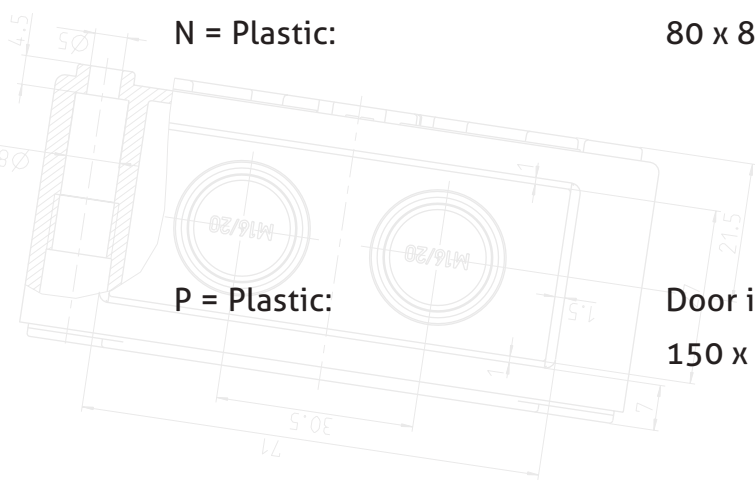

Images similar, not to scale

Housings

Controller

DGC-06 Housing

315 x 54 x 155 mm

More variants available

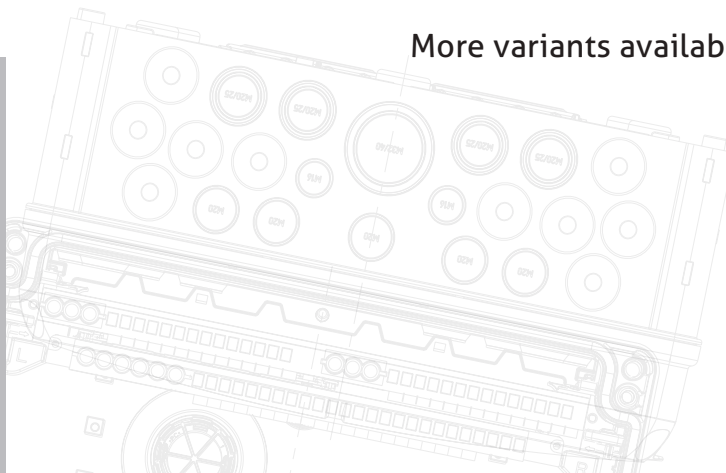

Controller in stainless steel housing

315 x 54 x 155 mm

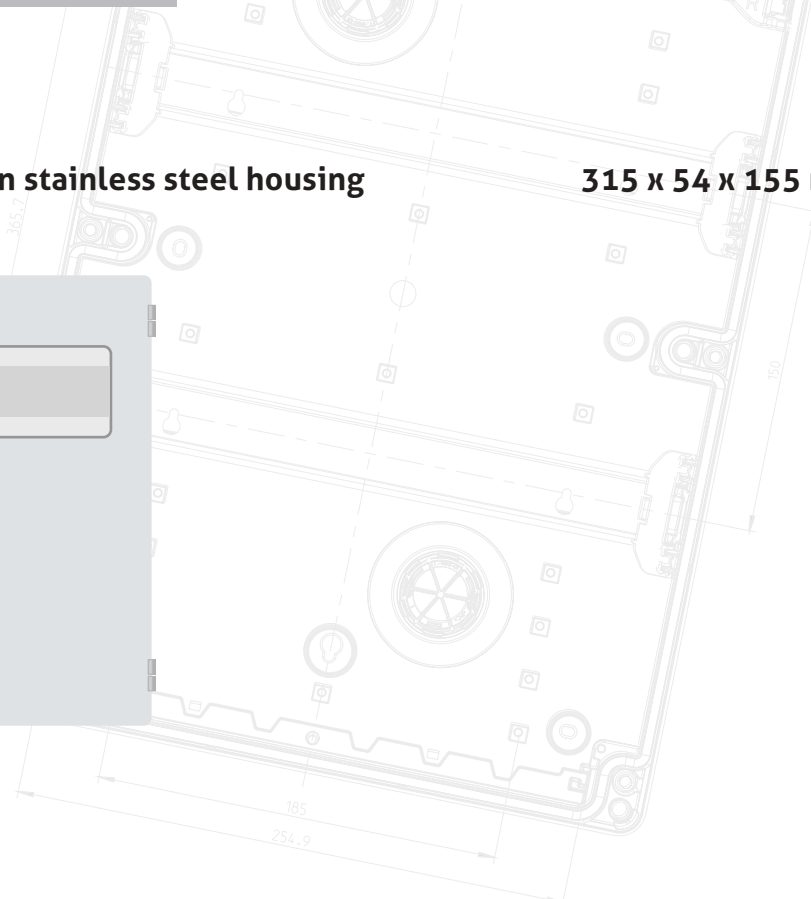
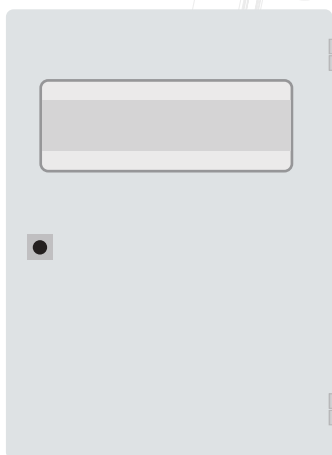

Images similar, not to scale



Product Codes

ARB2	Analog-Relay-Board
BL-24	Flashing light
C2-Z2	Duct mounting set
C2-Z4	Calibration adapter MC2/SC2
C2-Z5	SplashGuard
C2-Z6	Calibration adapter MC2/SC2
Cal01-PX2	Calibration adapter for PX2 sensors
DEM-06	Door-Entrance-Module
DGC-06	Digital-Gas-Controller
EP-06	Expansion-Module
EP-06-ES_FCM	Fire-Control-Module
EP-06-ES_FDM	Fire-Detection-Module
EP-06-ES_MOT	Motor-Control-Module
EP-06-ES_MCM	System-Module
GC-06	Gas-Controller
GC-06-ES	Gas-Controller
µG2	MycroGard2
MC2	Analog sensor head
MGC2	Multi-Gas-Controller
MSB2	Multi-Sensor-Board
MSB2-ES	Sensor-Board-Series MSB2-ES
MSC2	Multi-Sensor-Controller
MSR_Pen_PX2	Magnetic pen
OT-01	Tool for opening the stainless steel housing
PCE06	PCE06 Software
PG2	PolyGard2
PGCB	PolyGard Control Box
PX2	Sensor PolyXeta2
RB2	Remote-Board
RM2	Relay-Module
SB2	Sensor-Board
SB2U	SB2Unit
SC2	Digital sensor head
SG-PX2	SplashGuard for PolyXeta2 sensors
SP6-00	Sensor protection / guard rail
SSAX1	Sensorhead SSAX1 (PolyXeta2)
STA06-MC2	Converter for PCE06-PGX2 Service-Tool
STA06-PX2	Adapter for STL06-PGX2 und PCE06-PGX2 Service-Tool
STL06	Service-Tool
SX1	Sensor head SX1 (PolyXeta2)
WAO	Warn unit: visual/audible indicator
WH	Warning horn
WH-24	Warning horn, 24 V DC
WH-230	Warning horn, 230 V AC
WH/BL	Warning horn/flashing light combination
WH/BL-24	Warning horn/flashing light combination, 24 V DC
WH/BL-24-Tast	Warning horn/flashing light combination, 24 V DC + Button
WH/BL-230	Warning horn/flashing light combination, 230 V AC
WSB2	Warning and Sensor-Board
WT	Warning sign



Product Matrix

Combinations

	MC2 Analog	SC2 Digital	Housing	230 V AC	WAO Warning Device	Display
ARB2	1	0	A, C, N	1	1	with MC2
SB2	0	3*	A, C, 5	1	1	1
WSB2	1	2	A, C, E, N	1	1	1
MSB2	3*	2*	A*, C, E	1	1	1
MGC2	3*	2*	A*, C, E	1	1	1
MSC2	2*	2*	A*, C, E	1	1	1
DGC-06	32**	96 (+ SB2)	1, 2, 3, 4	1	0	1

* With restriction, see data sheet

** On controller with 7 EP-06 modules

Analog Input	Analog Output	Digital Input	Relay	UPS	Stand-Alone	
1	1	0	2	0	1	ARB2
0	0	0	0	1	0	SB2
1	1	1	2	1	1	WSB2
3	1	2	3	1	0	MSB2
3	1	2	3	1	1	MGC2
2	1	2	3	1	1	MSC2
32**	16**	16**	32**	1	1	DGC-06

Product Directory

Item no.	Page
PolyGard®2 Devices for Buildings	
Analog sensor cartridge MC2	32, 38, 132
Digital sensor cartridge SC2	32, 38, 134
Sensor Board SB2	40, 137
Warning and Sensor Board WSB2	42, 137
Multi Sensor Board MSB2	44, 136
Analog Relay Board ARB2	46, 136
Multi Sensor Controller MSC2	48, 138
Compactcontroller	50, 138
Multi Gas Controller MGC2	52, 139
Digital Gas Controller DGC-06	56, 138
Gas Controller Modules GC-06 and EP-06	58, 138
Door Entrance Module DEM-06	60, 137
Software und Tools	62, 139
Warning Devices	64, 140
Accessories	66, 140
Control Box	68, 139
MSR-Cloud	70
Extended Safety (ES) and Modules	72, 141
Intelligent Parking Guidance Systems	80, 142
PolyXeta®2 Devices for Industrial Plants	
Sensor Cartridge SX1	98, 102, 146
PolyXeta®2 Sensor Cartridge SSAX1	100, 102, 148
Controller and Modules	104, 150
Warning Devices	108, 151
Accessories	151
PolyMarine for Shipping	
	110, 152
PolySam® for Analysis	
	116



Worldwide Sales

MSR subsidiaries and partner network

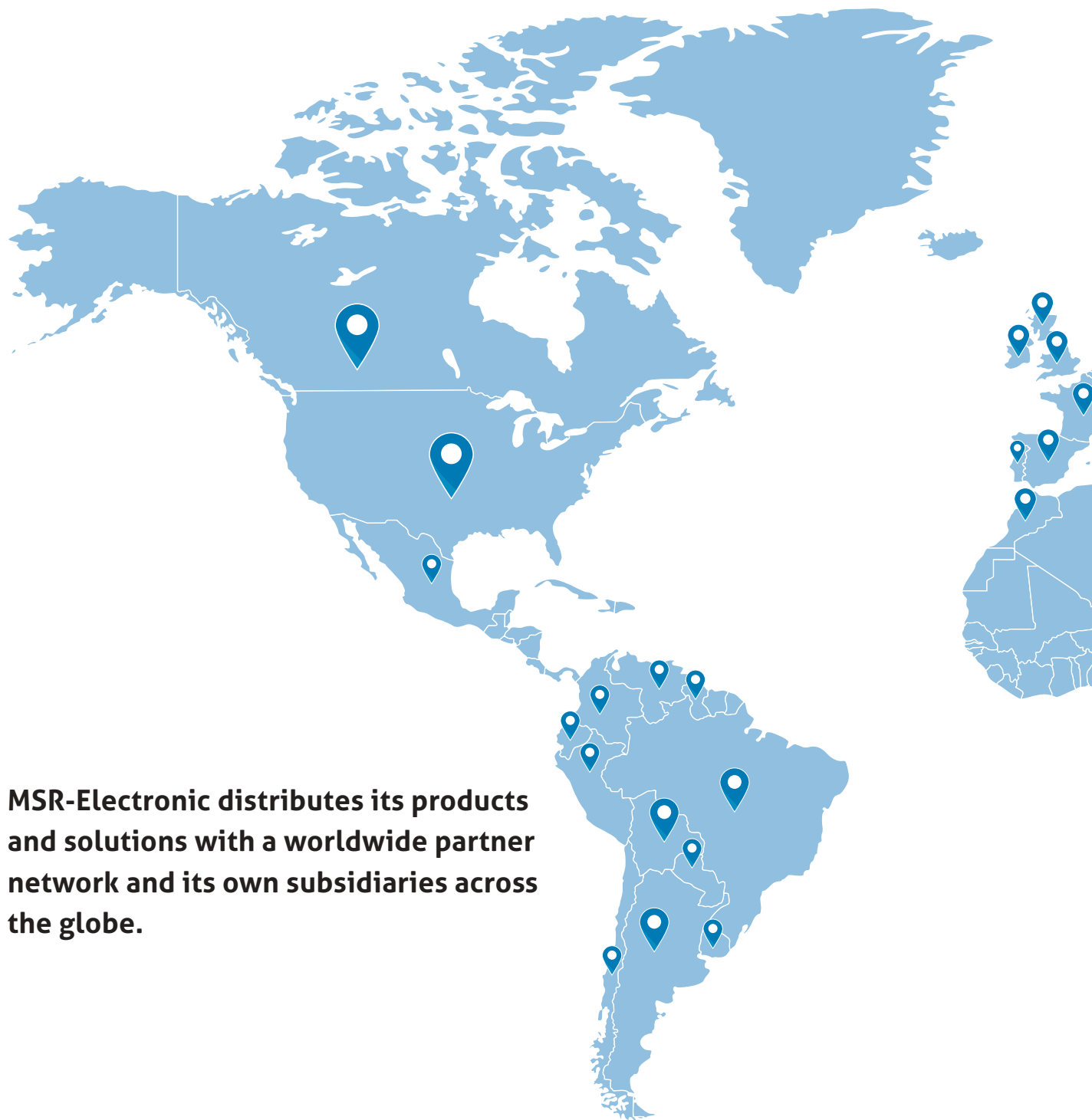

MSR-Electronic distributes its products and solutions with a worldwide partner network and its own subsidiaries across the globe.



MSR INTERNATIONAL

All info at www.msr-electronic.de/msr-partner



MSR
AUT

**Office for Austria, Hungary,
Slovakia and Czech Republic**

Stockerauer Straße 181
2100 Korneuburg, Austria
Fon: +43 2262 64819
Mail: info@msr-austria.at

MSR
ITA

**Office for Italy, Italian & French
Switzerland, South of France, Monaco
and Malta**

Piazza Dante n. 5
20022 Castano Primo (MI), Italy
Fon: +39 0331 152 8502
Mail: info@msr-italy.it

MSR
HRV

**Office for Croatia, Slovenia,
Bosnia and Herzegovina**

Barbat 86
51280 Rab, Croatia
Fon: +49 160 46 97 666
Mail: info@msr-arba.com

MSR-Group

Everything under one roof

The MSR-Group unites three innovative companies from the electronics sector. Whether gas alarm systems, parking guidance systems or sensors for building automation – the products

can be found in many commercial and industrial applications, such as parking garages, cold rooms, biogas plants or offices.

www.msr-group.eu



MSR-Electronic GmbH

For reliable gas monitoring and detection of gas leaks, MSR-Electronic offers: fixed gas warning systems with exchangeable sensor cartridges, controllers and warning devices for buildings, industrial plants, shipping and analysis.

www.msr-electronic.de



MSR-Traffic GmbH

MSR-Traffic GmbH stands for intelligent indoor and outdoor parking guidance systems. With wireless magnetic field sensors for outdoor use and smart cities as well as ultrasonic sensors for indoor use (underground car parks and parking garages), MSR-Traffic develops dynamic signposts for every parking system.

www.msr-traffic.de



MSR-International

MSR-Electronic distributes its products and solutions with a worldwide partner network and its own subsidiaries across the globe.

You will always find the right contact person in your area.

www.msr-electronic.de/msr-partner

A large white rectangular sign with the MSR logo in black. The logo consists of a small square to the left of the letters 'MSR' in a bold, sans-serif font.

MSR

Bürgermeister-Schönbauer-Straße 13

PERFECT SOLUTIONS FOR GAS ALARM SYSTEMS



MSR-Electronic GmbH

Bürgermeister-Schönbauer-Str. 13
94060 Pocking

Germany



www.energometrika.ru



+7 (495) 276-051



zakaz@energometrika.ru



ЭНЕРГОМЕТРИКА
www.energometrika.ru



■ All Products
■ Made
■ in Germany

All rights reserved for MSR-Electronic GmbH.

For further technical data please refer to the corresponding data sheets.

Product discontinuation, technical changes, printing errors and mistakes reserved.

Not all products are completely available from 01/2021.

Realisation: BRANDS & PROJECTS. Photos: MSR-Electronic, AdobeStock, iStock, freepic