

# ЭНЕРГОМЕТРИКА

[www.energometrika.ru](http://www.energometrika.ru)

## PMAC770H Power Meter Installation & Operation Manual



# Safety and precautions



## Dangers and warnings

- This equipment should only be installed by professionals.
- The manufacture shall not be responsible for failures caused by non-compliance with the instructions in this manual.



## Precautions

- After removing the package of the equipment, please read this manual carefully first, and be sure following the instructions for installation and setup.
- Please do disconnect the power supply before performing installation or changing wiring.
- All mechanical parts and covers shall be returned to the original position before powering on the equipment.
- The equipment shall be powered by a rated voltage supply, should not over the rated voltage value.
- This manual is not intended to contain all details or changes to the equipment, please contact us when there is any problem in installation, operation and maintenance.

**Failure to take these precautions may cause serious injury!**

# Contents

Chapter 1. Overview .....	6
Chapter 2. Product model.....	9
Chapter 3. Installation and wiring .....	10
3.1 Using environment .....	10
3.2 Dimensions and installation diagrams .....	10
3.3 Terminal diagram.....	12
3.3.1 Main body terminals definition .....	12
3.3.2 Expansion module terminals definition .....	14
3.4 Wiring .....	21
3.4.1 Power supply.....	21
3.4.2 Voltage & current wiring.....	21
3.4.3 Communication wiring .....	23
3.4.4 Digital input wiring .....	23
3.4.5 Relay output wiring.....	24
3.4.6 Pulse output wiring .....	24
3.4.7 Analog output wiring .....	25
Chapter 4. Technical features introduction .....	26
4.1 Measurement function .....	26
4.1.1 Measurement parameters overview .....	26
4.1.2 Voltage.....	27
4.1.3 Current.....	27
4.1.4 Active power.....	28
4.1.5 Reactive power.....	28
4.1.6 Apparent power .....	28
4.1.7 Power factor .....	29

4.1.8 Frequency .....	29
4.2 Power quality analysis function .....	30
4.2.1 Voltage deviation .....	30
4.2.2 Frequency deviation .....	30
4.2.3 Harmonic .....	31
4.2.4 Imbalance and sequence components measurement .....	32
4.2.5 Voltage flicker .....	33
4.2.6 Voltage swell, sag and interruption .....	33
4.2.7 K factor .....	33
4.2.8 Voltage crest factor .....	34
4.2.9 Current TDD .....	34
4.2.10 Load impedance .....	34
4.3 Electrical energy measurement function .....	35
4.3.1 Electrical energy measurement .....	35
4.3.2 Electrical energy overturn and clear .....	35
4.3.3 Electrical energy pulse output .....	35
4.3.4 Multi-tariff electrical energy .....	35
4.3.5 Historical electrical energy .....	37
4.4 Demand .....	37
4.4.1 Demand data .....	37
4.4.2 Demand measurement methods .....	37
4.5 Over limit measurement function .....	38
4.6 SOE record .....	41
4.7 PQ record .....	41
4.8 Waveform record .....	42
4.9 Extreme data record .....	42
4.10 Digital input .....	42

4.11 Relay output .....	43
4.12 Analog output .....	43
4.13 Communication .....	44
4.14 Timing .....	44
4.15 Store function .....	44
4.16 Real-time waveform.....	44
Chapter 5. Display and settings .....	45
5.1 Button .....	45
5.2 Indicator light.....	45
5.3 Settings and display .....	45
5.3.1 Basic measurement .....	46
5.3.2 Electrical energy measurement.....	47
5.3.3 Power quality.....	47
5.3.4 Event record.....	48
5.3.5 Real-time waveform.....	49
5.3.6 Waveform recording .....	50
5.3.7 Parameter settings .....	50
5.3.8 System info .....	80
Chapter 6. Technical specification .....	81
6.1 Device parameters .....	81
6.2 Performance specification .....	83
Chapter 7. Maintenance and troubleshooting .....	85

## Chapter 1. Overview

PMAC770H multi-function power meter (hereinafter referred as PMAC770H) is a new generation of intelligent power meter which was developed independently. The instrument has high precision measurement and metering functions, timer recording and multi-tariff billing functions. It also equips with comprehensive power quality measuring functions, which including harmonic analysis, imbalance components measurement, flicker monitoring, voltage swell/sag/interruption recording, voltage fast change capture, fault recording, event recording etc. With above features PMAC770H can meet the S level of power quality monitoring standard. Accurate fault diagnosis and positioning functions, for local abnormalities or local faults in the power supply and consumption system. It can accurately record a large amount of waveform and event information to identify and accurately judge potential, transient or continuous local faults to ensure the safe and reliable operation of users' power supply system.

PMAC770H basic technical features table :

Technical feature		Description
Measurement channels	Voltage channel quantity	4
	Current channel quantity	3
Basic measurements	U,I	■
	P,Q,S	■
	PF	■
	Frequency	■
Electrical energy	Full-wave energy	■
	Bid-directional energy	■
	Four quadrant energy	■
	Multi-tariff energy	■
Demand	Real-time demand	Slip/Fixed

function	Forecast demand	Slip/Fixed
	Extreme demand	Historical extreme demand
Multi-tariff		■
Power quantity analysis	Waveform sampling cycle	256 points/cycles
	Harmonic	63rd
	Voltage deviation	■
	Frequency deviation	■
	Imbalance	■
	Sequence components	■
	Flicker analysis	■
	Voltage swell/sag/interruption	■
	Rapid voltage change	■
Over-limit monitoring	Settable limits(in seconds)	68 sets
Data & event record	Extreme value record	■
	SOE event (1ms)	128pcs
	PQ(power quality) event (1ms)	128pcs
	PQ(power quality) event counting	■
	Waveform recording	Provides 128 transient interrupt recordings Adopt COMTRADE file format
Display	LCD	Colorful LCD
	Resolution	320*240
	Real-time waveform	Real-time waveform display

I/O	Digital input(DI)	<b>Max 11 digital inputs</b> ✓ 3 active switches(DI) are equipped as standard(rate input 220V±35%) ✓ 8 DI are optional (active or passive switch can be selected)
	Relay output(RO)	<b>Max 6 relay outputs</b> ✓ 2 RO are equipped as standard ✓ 4 RO are optional
	Analog output(AO)	<b>Max 4 analog outputs(4~20mA)</b> ✓ 4 AO are optional
Communication	RS485 interface	<b>Max 2 RS485 output</b> ✓ 1 RS485 is equipped as standard ✓ 1 optional RS485(Either one with the Ethernet port)
	Ethernet port(10/100M)	1 standard Ethernet port (Either one with the 2 <sup>nd</sup> RS485 module)
	SNTP timing	■
Waveform recording	Waveform recording	■

Note: ■Inherent functions    □Optional functions



## Chapter 2. Product model

Order information :

Model: PMAC770H-①-②-③	
① : expansion module 1	
N	None this module
SW	4 active DI(rated input 220V±35%)
SD	4 passive DI(rated input 30VDC)
R	2 RO
AO	2 AO(4~40mA)
② : expansion module 2	
N	None this module
SW	4 active DI(rated input 220V±35%)
SD	4 passive DI(rated input 30VDC)
R	2 RO
AO	2 AO(4~40mA)
EP	2 electrical energy pulse outputs
③ : expansion module 3	
N	None this module
LAN	1Ethernet port(10/100M)
C	1 RS485

## Chapter 3. Installation and wiring

### 3.1 Using environment

Hole size (mm)	90.00×90.00 ( + 0.80)
Dimensions (mm)	(L*W*H) 96.00×96.00×45.1(without expansion module) 96.00×96.00×66.6(with expansion module)
IP level	Front panel: IP52, side & back: IP30
Measuring mode	3P4W,3P3W
Working temperature	-20°C~+60°C
Storage temperature	-40°C~+85°C
Relative humidity	5%~95%,no condensation

### 3.2 Dimensions and installation diagrams

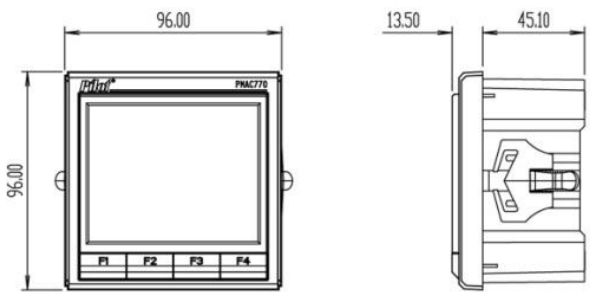

Without expansion module

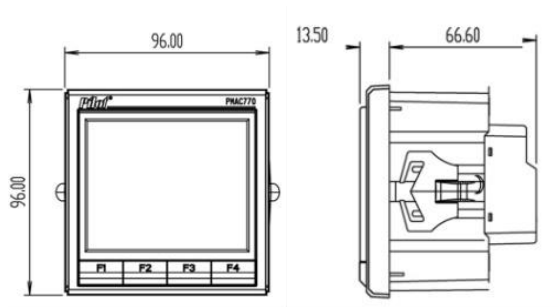

**With expansion module**

Dimensions diagram

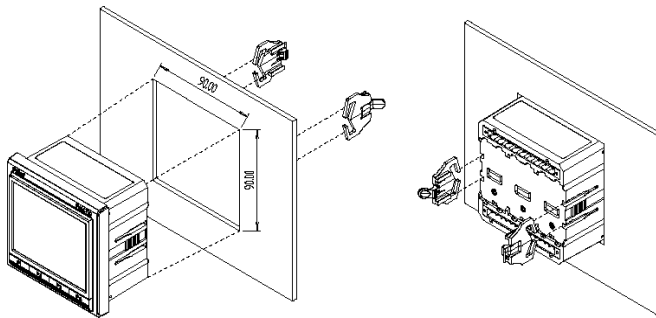

Installation diagram

### 3.3 Terminal diagram

#### 3.3.1 Main body terminals definition

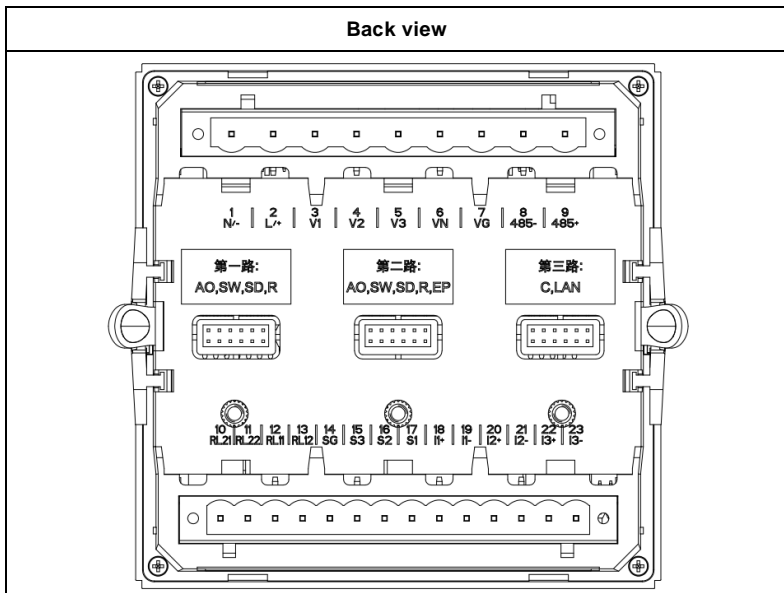

No.	Mark	Definition
1	N/-	220VAC neutral wire/220VDC negative pole
2	L/+	220VAC phase wire/220VDC positive pole
3	V1	Ua
4	V2	Ub
5	V3	Uc
6	VN	Un
7	VG	Un-G
8	485-	RS485A(-)
9	485+	RS485A(+)

10	RL21	2 <sup>nd</sup> RO_1
11	RL22	2 <sup>nd</sup> RO_2
12	RL11	1 <sup>st</sup> RO_1
13	RL12	1 <sup>st</sup> RO_2
14	SG	Digital input common point(-)
15	S3	3 <sup>rd</sup> DI(+)
16	S2	2 <sup>nd</sup> DI(+)
17	S1	1 <sup>st</sup> DI(+)
18	I1+	Ia(+)
19	I1-	Ia(-)
20	I2+	Ib(+)
21	I2-	Ib(-)
22	I3+	Ic(+)
23	I3-	Ic(-)

### 3.3.2 Expansion module terminals definition

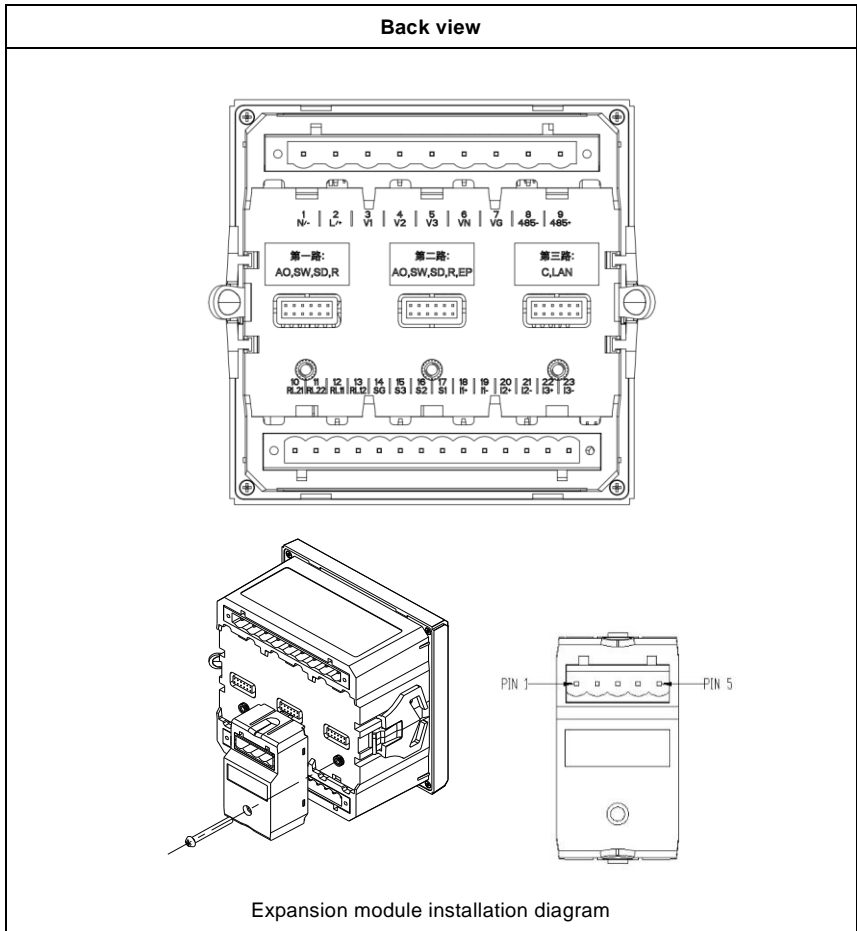

### 3.3.2.1 SW module definition

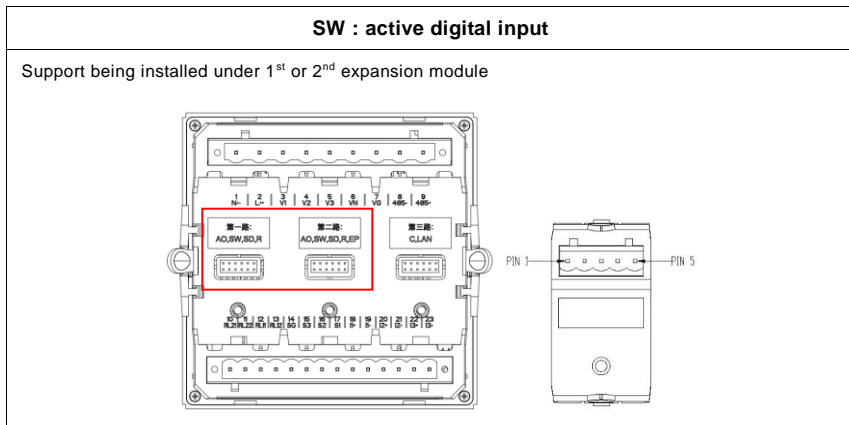

**1<sup>st</sup> expansion module position**

No	Mark	Definition
PIN1	EX S4	4 <sup>th</sup> digital input
PIN2	EX S5	5 <sup>th</sup> digital input
PIN3	EX S6	6 <sup>th</sup> digital input
PIN4	EX S7	7 <sup>th</sup> digital input
PIN5	EX SG1	Common point

**2<sup>nd</sup> expansion module position**

PIN1	EX S8	8 <sup>th</sup> digital input
PIN2	EX S9	9 <sup>th</sup> digital input
PIN3	EX S10	10 <sup>th</sup> digital input
PIN4	EX S11	11 <sup>th</sup> digital input
PIN5	EX SG2	Common point

### 3.3.2.2 SD module definition

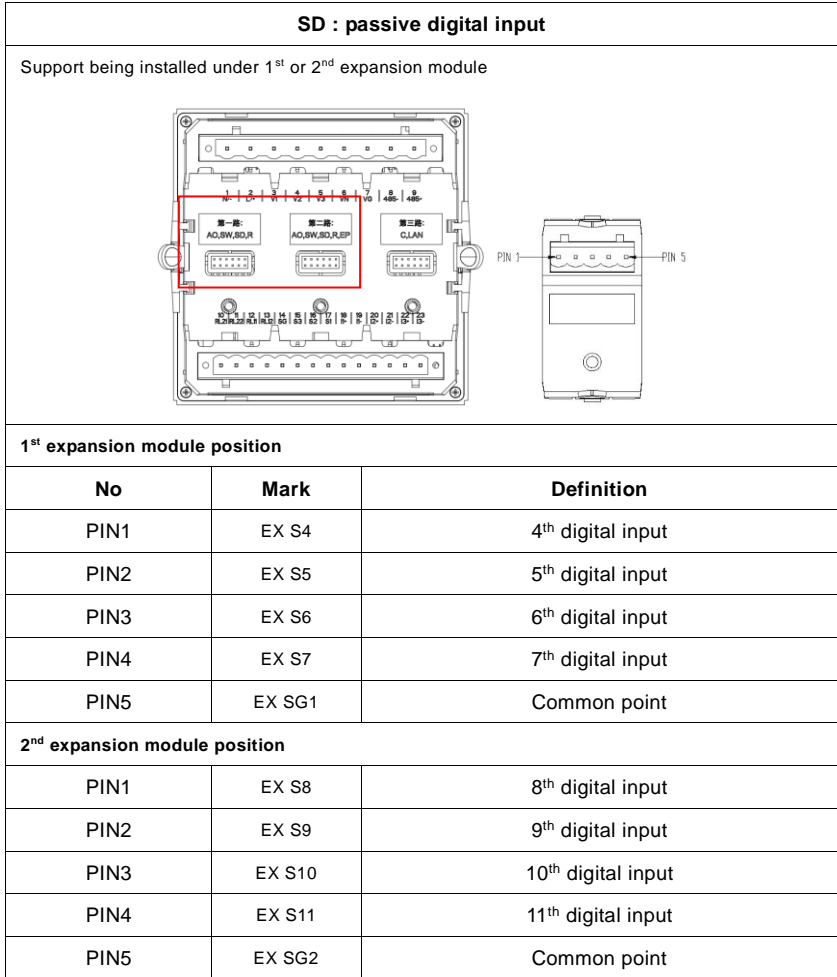



### 3.3.2.3 R module definition

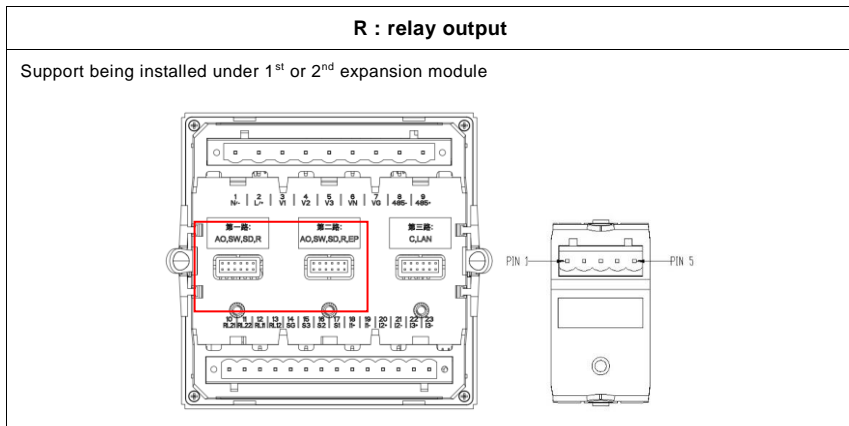

#### 1<sup>st</sup> expansion module position

No	Mark	Definition
PIN1	EX RL31	3 <sup>rd</sup> relay output_1
PIN2	EX RL32	3 <sup>rd</sup> relay output_2
PIN3	NC	Null
PIN4	EX RL41	4 <sup>th</sup> relay output_1
PIN5	EX RL42	4 <sup>th</sup> relay output_2

#### 2<sup>nd</sup> expansion module position

PIN1	EX RL51	5 <sup>th</sup> relay output_1
PIN2	EX RL52	5 <sup>th</sup> relay output_1
PIN3	NC	Null
PIN4	EX RL61	6 <sup>th</sup> relay output_1
PIN5	EX RL62	6 <sup>th</sup> relay output_1

### 3.3.2.4 AO module definition

#### AO : analog output(4~20mA)

Support being installed under 1<sup>st</sup> or 2<sup>nd</sup> expansion module

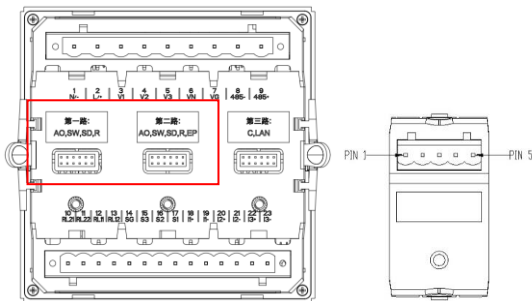

#### 1<sup>st</sup> expansion module position

No	Mark	Definition
PIN1	EX AO11	1 <sup>st</sup> AO_1
PIN2	EX AO12	1 <sup>st</sup> AO_2
PIN3	NC	Null
PIN4	EX AO21	2 <sup>nd</sup> AO_1
PIN5	EX AO22	2 <sup>nd</sup> AO_2

#### 2<sup>nd</sup> expansion module position

PIN1	EX AO31	3 <sup>rd</sup> AO_1
PIN2	EX AO32	3 <sup>rd</sup> AO_2
PIN3	NC	Null
PIN4	EX AO41	4 <sup>th</sup> AO_1
PIN5	EX AO42	4 <sup>th</sup> AO_2

### 3.3.2.5 EP module definition

#### EP: electrical energy pulse output

Only support being installed under 2<sup>nd</sup> expansion module

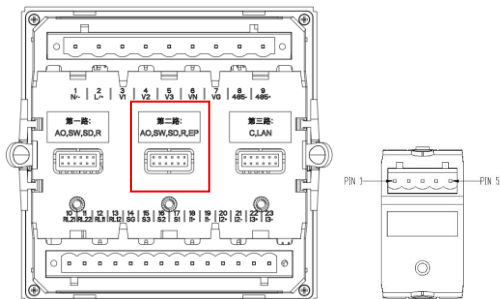

No	Mark	Definition
PIN1	EX P1+	Active energy pulse output(+)
PIN2	EX P1-	Active energy pulse output(-)
PIN3	NC	Null
PIN4	EX P2+	Reactive energy pulse output(+)
PIN5	EX P2-	Reactive energy pulse output(-)

### 3.3.2.6 C module definition

#### C: RS485 communication module

Only support being installed under 3<sup>rd</sup> expansion module

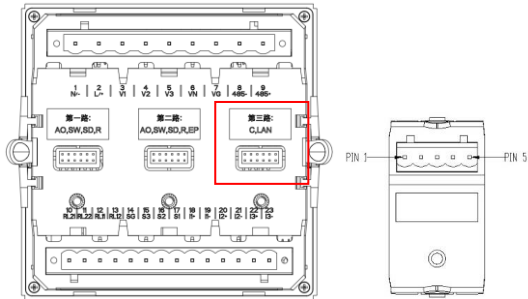

No	Mark	Definition
PIN1	NC	Null
PIN2	NC	Null
PIN3	NC	Null
PIN4	EX 485-	RS485 -
PIN5	EX 485+	RS485 +

### 3.3.2.7 LAN module definition

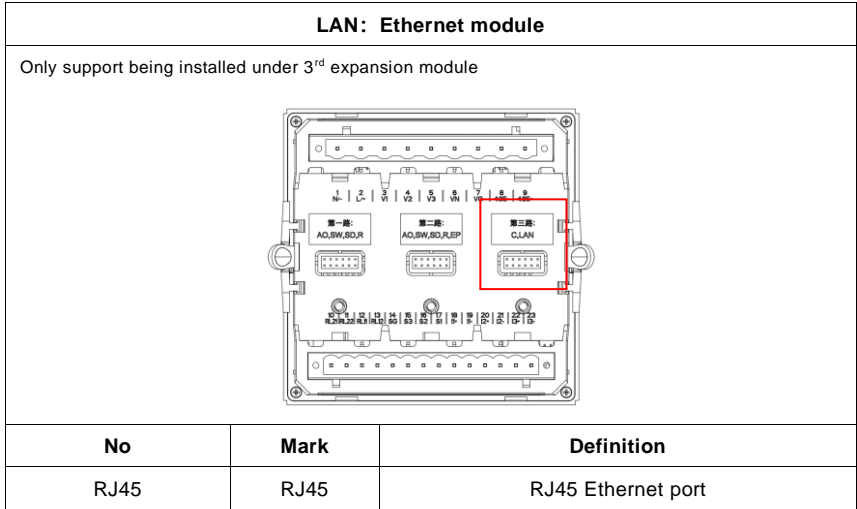

## 3.4 Wiring

### 3.4.1 Power supply

When powered by AC power system, phase wire connected to L/+, neutral wire connected to N/-. While powered by DC power system, positive pole connected to L/+, negative pole connected to N/-.

### 3.4.2 Voltage & current wiring

PMAC770H supports multiple wiring modes, show as below

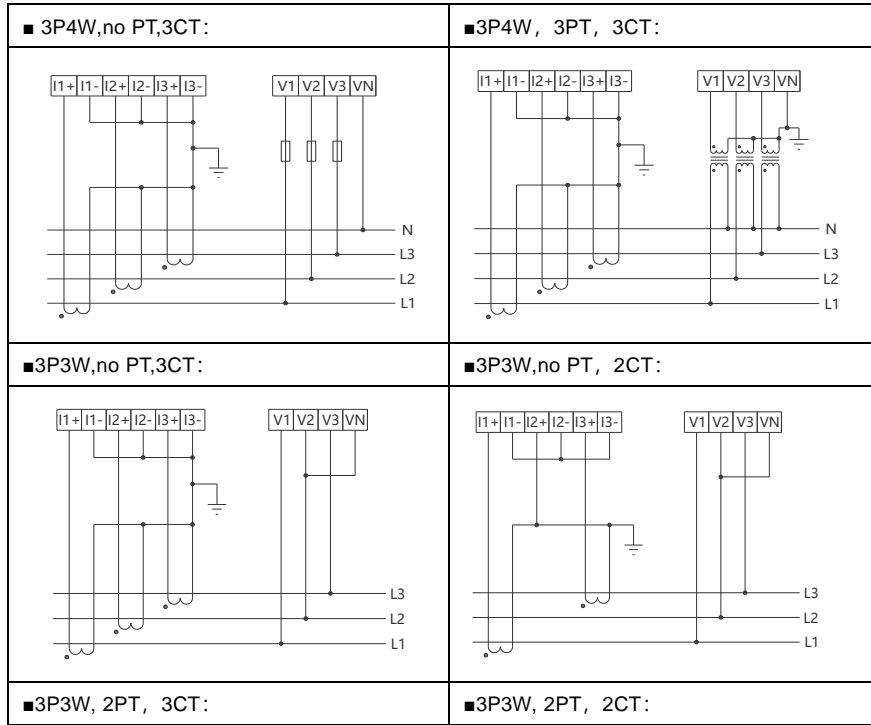
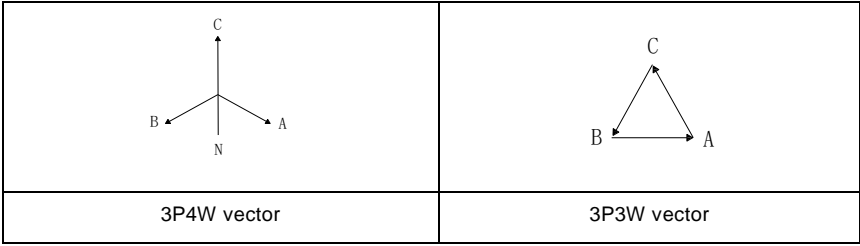

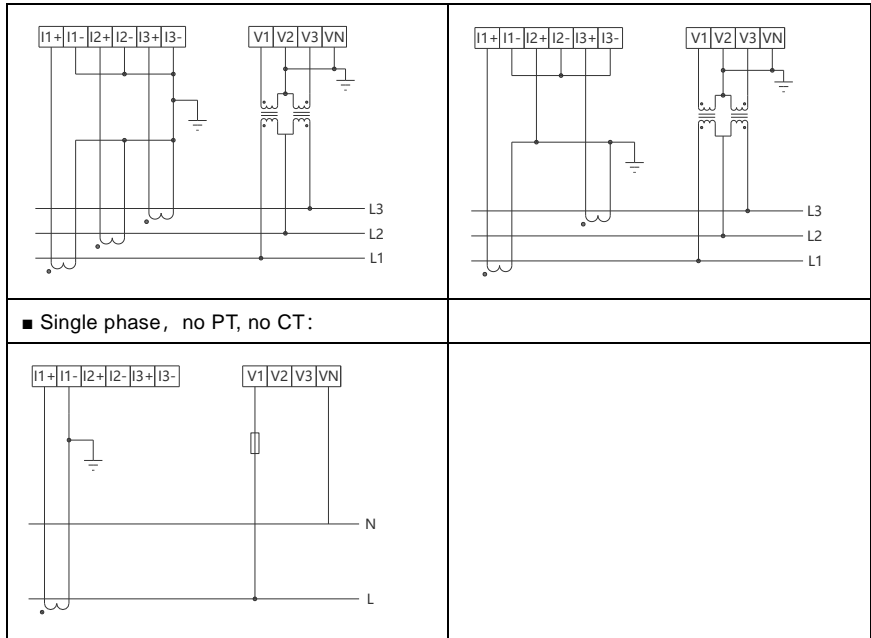

### 3.4.3 Communication wiring

#### (1) RS-485 interface

PMAC770H provides 2 RS485 interfaces:

- 1 equipped as standard: RS485A+/RS485A-
- 1 equipped as expansion module: RS485B+/RS485B-

When the RS485 shielded twisted pair is too long, one 120Ω resistor is recommended to connect at the wire end to ensure the communication quality.

#### (2) Ethernet interface equips with RJ-45 connector and 10/100M port.

### 3.4.4 Digital input wiring

PMAC770H provides 11 digital inputs (marks as DI1–D11) at maximum to monitor

switch/breaker position signal, there are passive DI and active DI can be selected as per requirement.

- Passive DI

The below wiring mode is used usually when outer source just provides a switch position and requests the DI reflecting a switch close signal.

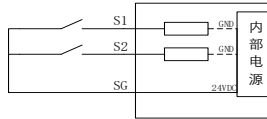

- Active DI

The below wiring mode is used usually when outer source provides switch position and voltage signal(input voltage 220VDC±35%).

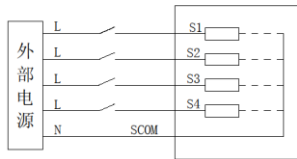

### 3.4.5 Relay output wiring

PMAC770H provides 6 relay outputs (marks as RO1~RO6) at maximum, all are normal open(NO) relays, can be used to cut off load of 250VAC/5A or 30VDC/5A or 220VDC/0.2A, an intermediate relay is recommended when the load current is large.

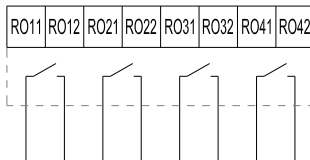

### 3.4.6 Pulse output wiring

PMAC770H provides two pulse outputs as optional function to reflect electrical energy measuring, the first pulse output channel used to reflect total active electrical energy, the



second pulse output used to reflect total reactive electrical energy, the pulse constant is 3600, and the width is 80ms.

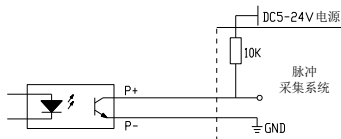

### 3.4.7 Analog output wiring

PMAC770H provides 2 expansion modules for adding analog output interface, the max load for AO is  $750\Omega$ , output range is 4~40mA, 1.2 times overload.

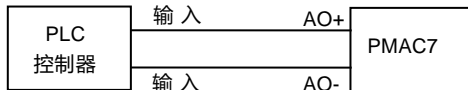

## Chapter 4. Technical features introduction

### 4.1 Measurement function

#### 4.1.1 Measurement parameters overview

Type	Description	A	B	C	Total	Average	Zero sequence	Measure range
U	Phase voltage	√	√	√		√	√	0-690kV
	Line voltage	√	√	√		√		
	Phase angle	√	√	√				
I	Current	√	√	√		√	√	0-50000A
	Phase angle	√	√	√				
Power	P	√	√	√	√			1 phase:0-34500M W
	Q	√	√	√	√			1 phase:0-34500M Var
	S	√	√	√	√			1 phase:0-34500M VA
PF	PF	√	√	√	√			

Freque ncy	Frequenc y	√						35~65Hz
---------------	---------------	---	--	--	--	--	--	---------

**Note:** Under 3P3W wiring mode, phase voltage, active power, reactive power, apparent power and power factor are meaningless for each phase.

#### 4.1.2 Voltage

PMAC770H can be used as direct connect when the measured phase voltage is lower than 398V or line voltage is lower than 690V, it shall work with PT when input voltage is larger than above value. To keep the meter reflect accurate measuring, please pay attention to the linearity and accuracy of the PT when wiring.

The overload capacity for voltage measuring by PMAC770H is 120%, the rated max measuring range is 690KV, the wiring mode of voltage measuring can be set over the panel or Modbus register, both 3P4W and 3P3W methods are supported for low voltage and high voltage situation.

**Note:**

- 1) **Please clear the electrical energy after changing the wiring method if any.**
- 2) **PT ratio range is 1.00~6900.00**

#### 4.1.3 Current

PMAC770H shall work with external CT for current measuring, and the secondly value of the CT shall be 5A to connect to PMAC770H, please avoid open circuit when doing CT wiring, as this may damage the device, most importantly this may bring danger to installation and maintenance people

The overload capacity for current measuring by PMAC770H is 120%, the rated max measuring range is 50000A, the CT ratio range is 1.00~10000.00.

#### **4.1.4 Active power**

PMAC770H supports measuring each phase active power ( $P_a$ ,  $P_b$ ,  $P_c$ ) and total active power, single phase max measuring range is 34500MW, three phase max measuring range is 103500MW.

#### **4.1.5 Reactive power**

PMAC770H supports measuring each phase reactive power ( $Q_a$ ,  $Q_b$ ,  $Q_c$ ) and total reactive power, single phase max measuring range is 34500MVar, three phase max measuring range is 103500MVar.

**Note:**

- 1) Active and reactive power are signed values**
- 2) Please pay attention to the phase sequence correspondence between voltage and current when wiring, as this may impact the accuracy of power calculating.**
- 3) Please pay attention to the wiring of CT homonymous ends, wrong wiring may bring a measured negative value for power**

#### **4.1.6 Apparent power**

PMAC770H supports measuring each phase apparent power ( $S_a$ ,  $S_b$ ,  $S_c$ ) and total apparent power, single phase max measuring range is 34500MVA, three phase max measuring range is 103500MVA.

### 4.1.7 Power factor

PMAC770H supports measuring each phase and total power factor, and the measure range is -1.000~+1.000.

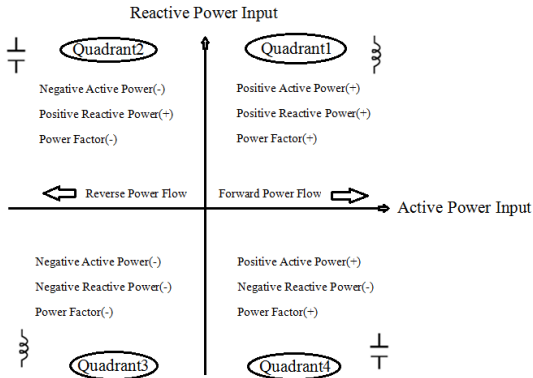

### 4.1.8 Frequency

The frequency measuring range of PMAC770H is 36~65Hz, the measuring channel is different under different wiring mode. Under 3P3W wiring mode, PMAC770H takes frequency sample from line AB as default, if line AB is phase loss then takes from line CA, if both line AB and line CA are loss then the value will be 0. Under other wiring mode, PMAC770H will take frequency sample from phase channel (A/B/C).

## 4.2 Power quality analysis function

### 4.2.1 Voltage deviation

In a running power supply system, the difference between the actual measured voltage at the measuring point and the nominal voltage of the system as a percentage of the nominal voltage of the system is called voltage deviation, and voltage deviation including upper and lower deviation.

(1) Upper deviation

$$U_{over}(\%) = \frac{\sqrt{\frac{\sum_{i=1}^n U_{rms-over,i}^2}{n}} - U_{din}}{U_{din}} \times 100\%$$

$U_{rms-over,i}$  : i-th 10 points/cycles RMS value

When  $U_{rms-200ms,i}$  is less than  $U_{din}$ , then  $U_{rms-over,i}$  equals  $U_{din}$

When  $U_{rms-200ms,i}$  is larger or equals  $U_{din}$ , then  $U_{rms-over,i}$  equals  $U_{rms-200ms,i}$

(2) Lower deviation

$$U_{under}(\%) = \frac{U_{din} - \sqrt{\frac{\sum_{i=1}^n U_{rms-under,i}^2}{n}}}{U_{din}} \times 100\%$$

$U_{rms-over,i}$  : i-th 10 points/cycles RMS value

When  $U_{rms-200ms,i}$  is larger than  $U_{din}$ , then  $U_{rms-under,i}$  equals  $U_{din}$

When  $U_{rms-200ms,i}$  is less or equals  $U_{din}$ , then  $U_{rms-under,i}$  equals  $U_{rms-200ms,i}$

PMAC770H calculates the voltage deviation according to the requirements of GB/T12325-2008 standard, the voltage measurement accuracy of the device is 0.1%, it can achieve continuous voltage deviation monitoring and alarm recording for power system.

### 4.2.2 Frequency deviation

In a normal running power system, the frequency difference between the actual measured and nominal values of the system is called frequency deviation, the formula is

show as below:

$$\text{Frequency deviation} = \text{actual frequency} - \text{nominal frequency}$$

PMAC770H has a frequency measurement accuracy of  $\pm 0.01\text{Hz}$ , enabling it can achieve continuous frequency monitoring, and it equips over limit alarm and recording features as well.

## 4.2.3 Harmonic

### 4.2.3.1 Harmonic

PMAC770H is fully compliant with IEC61000-4-7 standard, and takes 256 sampling points at each cycle for harmonic analysis.

Type	Parameters	UA	UB	UC	IA	IB	IC	Range	Accuracy
Harmonic distortion rate	Voltage THD	√	√	√	√	√	√	0~100%	S class
	Voltage odd THD	√	√	√	√	√	√	0~100%	S class
	Voltage even THD	√	√	√	√	√	√	0~100%	S class
	Current THD	√	√	√	√	√	√	0~100%	S class
	Current odd THD	√	√	√	√	√	√	0~100%	S class
	Current even THD	√	√	√	√	√	√	0~100%	S class
Harmonic ratio	Harmonic voltage ratio	√	√	√	√	√	√	2~63 <sup>rd</sup>	S class
	Harmonic current ratio	√	√	√	√	√	√	2~63 <sup>rd</sup>	S class
Harmonic RMS	Harmonic voltage RMS	√	√	√	√	√	√	0~63 <sup>rd</sup>	S class
	Harmonic current RMS	√	√	√	√	√	√	0~63 <sup>rd</sup>	S class
	Harmonic power RMS	√	√	√	√	√	√	0~63 <sup>rd</sup>	S class
Other	Voltage crest factor	√	√	√	√	√	√	/	S class
	Current K factor	√	√	√	√	√	√	/	S class
	Frequency deviation	√	√	√	√	√	√	0~100%	S class

	Voltage deviation	√	√	√	√	√	√	0~100%	S class
	Voltage imbalance rate	√	√	√	√	√	√	0~100%	S class

#### 4.2.3.2 Fundamental wave parameters measurement

PMAC770H provides complete fundamental data for power system running status analysis

	Phase A	Phase B	Phase C	Total	Neutral line
Phase voltage	√	√	√		√
Line voltage	√	√	√		
Current	√	√	√		√
Active power	√	√	√	√	
Reactive power	√	√	√	√	
Apparent power	√	√	√	√	

#### 4.2.4 Imbalance and sequence components measurement

In an ideal three-phase power supply system, the A/B/C phase voltage and current shall be equal correspondingly and with 120° phase angle difference, that's a balance situation. When the actual system deviates from the above situation, the issue of imbalance and the corresponding reduction in power utilization efficiency arises.

PMAC770H can measure the positive sequence, negative sequence and zero sequence amplitude and phase angle of voltage and current, and calculate and analysis voltage and current imbalance degree which including negative and zero sequence imbalance.

##### (1) Negative sequence imbalance of voltage and current

$U_2 = (\text{voltage negative sequence component} / \text{voltage positive sequence})$



component)X100%

$I_2 = (\text{current negative sequence component} / \text{current positive sequence component}) \times 100\%$

(2) Zero sequence imbalance of voltage and current

$U_0 = (\text{voltage zero sequence component} / \text{voltage positive sequence component}) \times 100\%$

$I_0 = (\text{current zero sequence component} / \text{current positive sequence component}) \times 100\%$

#### **4.2.5 Voltage flicker**

The voltage flicker measurement range of PMAC770H is 1~20, its calculation mode is based on the IEC61000-4-15 standard, can fully meet the requirements.

#### **4.2.6 Voltage swell, sag and interruption**

There are many causes can bring voltage swell, sag and interruption to the power system, such as load adjustment, throwing of compensation capacitors and short-circuit fault at long distance, the above voltage changes are the main causes of abnormal operation of industrial equipment.

A) record each moment of the occurrence of voltage transient change and each phase voltage missing value

B) waveform recording can be triggered on each voltage transient change

PMAC770H voltage swell, sag and interruption measurement can meet standards of GB/T18481-2001 and IEC61000-4-30

#### **4.2.7 K factor**

Among the power quality technical analysis indicators, K factor is mainly used to reflect the influence of the frequency harmonic which caused by non-linear loads on transformer losses,

the K factor is defined mainly under the assumption that the transformer eddy current losses caused by harmonic currents are proportional to the square of the number of harmonics, the calculation formula is show as below:

$$K = \frac{\sum_{h=1}^{\infty} I_h^2 h^2}{\sum_{h=1}^{\infty} I_h^2} = \frac{\sum_{h=1}^{h_{\max}} I_h^2 h^2}{\sum_{h=1}^{h_{\max}} I_h^2}$$

In above formula, h represents harmonic order,  $I_h$  is the harmonic current RMS of h-th order,  $h_{\max}$  is the highest harmonic order

#### **4.2.8 Voltage crest factor**

PMAC770H supports voltage crest factor measurement and this can be checked over Modbus register list. The crest factor is the ratio of the load's crest voltage to the RMS voltage, the normally crest value for most electronic device is 1.4

#### **4.2.9 Current TDD**

TDD is an abbreviation of total distortion rate of demand parameter, PMAC770H supports three-phase current TDD measurement and this can be checked over Modbus register list.

#### **4.2.10 Load impedance**

PMAC770H supports three-phase load impedance and total load impedance detection function, the load impedance is judged by active and reactive power.

- 1) When  $P=0$  and  $Q=0$ , then the load impedance is resistive
- 2) When  $P>0$  and  $Q>0$ , then the load impedance is inductive
- 3) When  $P<0$  and  $Q<0$ , then the load impedance is inductive
- 4) When  $P<0$  and  $Q>0$ , then the load impedance is capacitive
- 5) When  $P>0$  and  $Q<0$ , then the load impedance is capacitive

## 4.3 Electrical energy measurement function

### 4.3.1 Electrical energy measurement

PMAC770H provides full electrical energy data measurement technical feature as below table:

	Positive	Reverse	Net value	Total
Full wave(P)	√	√	√	√
Full wave(Q)	√	√	√	√
Full wave(S)				√
Fundamental wave (P)	√	√	√	√
Fundamental wave (Q)	√	√	√	√
Fundamental wave (S)				√

### 4.3.2 Electrical energy overturn and clear

The max electrical energy that PMAC770H can record is 99999999.999, when the actual electrical energy is larger than that, then the device will overturn the energy to zero and record further, energy clear operation can be done over Modbus register list.

### 4.3.3 Electrical energy pulse output

PMAC770H supports active energy and reactive energy pulse output function.

### 4.3.4 Multi-tariff electrical energy

PMAC770H equips with two tariff solutions, each tariff solution consists of settings including time zone (counting season), normal day period and special day period. In a power supply system, the electricity price may be different in working days, weekend and holiday, as well as during peak and off-peak periods. So the multi-tariff function is used to meet the needs of different electricity price periods, multi-tariff function can measure the positive and negative active/reactive/apparent electrical energy, and the max measurement range is 99999999.9KWH.

Parameter setting range :

Counting season: 1~12 time zone, times zone 1 counting from 1<sup>st</sup> of January and cannot

be modified. When setting to 0xFFFF or other non-existent date, then it will be judged as invalid date. If any time zone in the counting solution has been set to 0xFFFF, then all dates after the time zone should be set to 0xFFFF. The time zone setting rule is the later time zone date should be later than the date of previous time zone, except for all the later time zone have been set to 0xFFFF.

Counting day type: working day/weekend/holiday/special day, time period can be set under each type.

Time period : 20 daily time period tables can be set at maximum, and each daily period table can set up to 12 time periods, the minimum time unit for each time period is 15 min. If the value is 0, then it means the current time period uses daily period table 1 for counting, the valid time from the start date of the time zone to the start date of next time zone, if the start date of next time zone has been set to 0xFFFF, then the valid time shall be from the start date of the time zone to the end of the year, the time period setting rule is the time of later time period shall be later than the time of the previous time period, except for all the later time periods have been set to 0xFFFF.

Special day: 0~90 pcs, each special day can set daily time period separately.

Tariff : sharp ,peak ,flat, valley

**This multi-tariff function can only be set and read over Modbus register list.**

Time period setting sample:

Time period	Start time	Tariff
1# period	0:00	1
2# period	3:15	2
3# period	5:30	3
4# period	7:45	4
5# period	9:00	1
6# period	12:15	4
7# period	15:45	2
8# period	18:00	3
9# period	20:30	1

10# period	22:00	4
11# period	22:30	2
12# period	23:15	3

### 4.3.5 Historical electrical energy

PMAC770H supports recording the latest 31 days daily historical energy data, latest 12 months monthly historical energy data and latest 5 years yearly historical energy data.

## 4.4 Demand

In a power system demand usually refers to the average power consumption over a certain time interval (usually is 15 minutes).

### 4.4.1 Demand data

PMAC770H measures active power demand, total reactive power demand, total apparent power demand, three-phase current demand and forecast demand, and provides fixed demand and slip demand two measurement methods.

### 4.4.2 Demand measurement methods

There are slip cycle and fixed cycle measurement methods for demand calculating, the system add the calculated values per second, then take the average value at the end of the demand calculation cycle and output the result. The system use the same calculation principle for current and power demand measurement, the demand measurement cycle can be set to 5/10/15/30/60min.

Fixed demand method: once the demand measurement cycle is reach, the system will calculate the average value as per the fixed demand cycle and output the value.

Slip demand method: the slip cycle can be set to 1/2/3/5min, once the demand measurement cycle is reach, the system will slip based on the set slip cycle(1/2/3/5min) to calculate the average value and output the value.

Forecast demand: for normal demand measurement, the value is output after the demand measurement cycle, but for forecast demand, the output demand value at the end of

the measurement cycle is calculated based on the current forecast value. PMAC770H refresh the forecast demand at each second.

## 4.5 Over limit measurement function

PMAC770H over limit measurement settings can only master software via communication, and the maximum over limit setting is 69 sets, each set including below contents:

- (1) Trigger way: on or off
- (2) Object:

Table 4-5 Settable alarm parameters

Over limit type	Objects
	Phase voltage
	Line voltage
	Phase current
	Frequency
	Total active power
	Total reactive power
	Total apparent power
	Power factor
	Import total active power real-time demand
	Export total active power real-time demand
	Import total reactive power real-time demand
	Export total reactive power real-time demand
	Import total active power forecast demand
	Export total active power forecast demand
	Import total reactive power forecast demand
	Export total reactive power forecast demand

	Import total apparent power real-time demand
	Export total apparent power real-time demand
	Voltage THD rate
	Current THD rate
	Voltage negative sequence imbalance degree
	Voltage zero sequence imbalance degree
	Current negative sequence imbalance degree
	Current zero sequence imbalance degree
	3 <sup>th</sup> /5 <sup>th</sup> /7 <sup>th</sup> /9 <sup>th</sup> /11 <sup>th</sup> /13 <sup>th</sup> voltage harmonic ratio
	3 <sup>th</sup> /5 <sup>th</sup> /7 <sup>th</sup> /9 <sup>th</sup> /11 <sup>th</sup> /13 <sup>th</sup> current harmonic ratio
	DI state
	Phase voltage deviation upper limit
	Line voltage deviation upper limit
	Frequency deviation upper limit
	Phase voltage deviation rate upper limit

(3) upper limit/lower limit:

1) upper limit: recovery value= action value - hysteresis value

If the measured value of the monitoring object is larger than the action value and the duration time exceeds the action delay, the alarm will be triggered, and if the measured value is less than the recovery value then the alarm will be recovery

2) lower limit: recovery value=action value + hysteresis value

If the measured value of the monitoring object is less than the action value and the duration time exceeds the action delay, the alarm will be triggered, and if the measured value is larger than the recovery value then the alarm will be recovery

(4) action delay: the time interval from detected an over limit to take an action, the setting

range is 0~120s

(5) trigger type: over limit trigger action

All over limit action will generate SOE record, and there are relay and light signal output can be set.

Note: DI state

- 1) value 0 means alarm open
- 2) value 1 means alarm close
- 3) None means alarm action delay

(6) Below is the logic description for upper limit alarm and lower limit alarm actions :

Figure 4-3 describes the situation of upper limit alarm, here takes relay output as trigger object. When measurement value of the measured parameter is larger than the set upper limit and the duration is over action delay time, then an alarm will be generated and trigger the relay output, after the measurement value of the measured parameter is less than the set lower limit and the duration is over return delay, then relay return to original state.

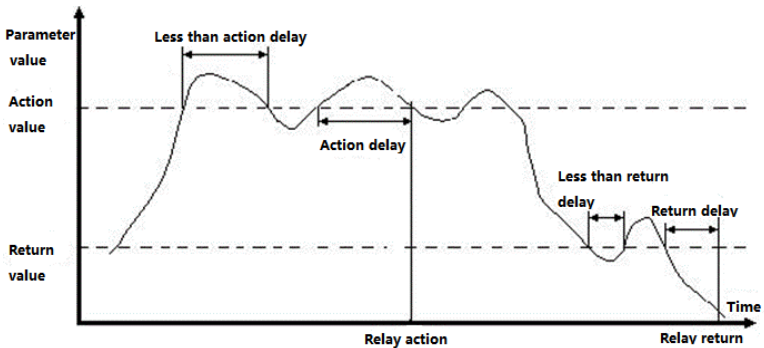

Figure 4-3 Upper limit

Figure 4-4 describes the situation of lower limit alarm, here takes relay output as trigger object. When measurement value of the measured parameter is less than the set lower limit and the duration is over action delay time, then an alarm will be generated and



trigger the relay output, after the measurement value of the measured parameter is larger than the set upper limit and the duration is over return delay, then relay return to original state.

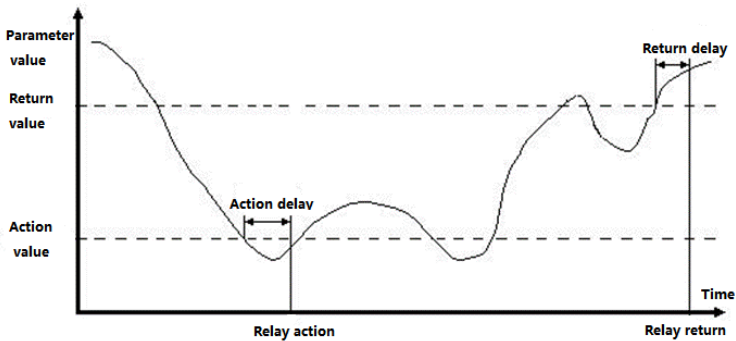

Figure 4-4 Lower limit

**Note:** An alarm will be generated once any phase trigger, and the alarm can be eliminated only when three phases recovery to normal value.

## 4.6 SOE record

PMAC770H supports recording up to 128pcs SOE events and without data loss even power outage, the events including over limit alarms, relay action, digital input state etc. SOE event is consists of event type, occur time and value, the time resolution is 1ms.

All SOE events can be read by master device over Modbus register list, and the record will be overturn when the capacity is reach to 128pcs.

## 4.7 PQ record

PMAC770H supports recording up to 128pcs PQ events and without data loss even power outage, it mainly records the power quality events including voltage swell, sag and interruption and voltage rapid change, each PQ event is consists of event type, occur time

and value, the time resolution is 1ms.

## 4.8 Waveform record

PMAC770H supports recording up to 128pcs waveform which including three phase voltage and three phase current, the default sampling cycle is 256 points/cycles, the recorded waveform will be installed into system file as COMTRADE format, and without data loss even power outage.

## 4.9 Extreme data record

PMAC770H supports recording the real-time extreme measured value and timestamps, parameters including:

- Three-phase current
- Phase voltage and line voltage
- Neutral line current/ neutral line to ground voltage
- Three-phase active power/reactive power/apparent power
- Total active power/reactive power/apparent power
- Frequency

## 4.10 Digital input

PMAC770H provides 11 digital inputs which marked as DI1~DI11, they are used to measure the switch position and state, digital inputs including active and passive two types, shall be selected as per actual needs.

Digital input state can be checked from LCD directly or via reading Modbus register, DI event is collected into SOE record, the time resolution is 1s.

DI No.	Position	Type
S1,S2,S3	Main body equipped	Active digital input:
S4,S5,S6,S7	Expansion module 1	SW model: active digital input(143~297VAC rated input) SD model: passive digital input(dry contact)

S8,S9,S10,S11	Expansion module 2	SW model: active digital input(143~297VAC rated input) SD model: passive digital input(dry contact)
---------------	--------------------	--

### 4.11 Relay output

PMAC770H supports two control modes for relay output which is remote control and local control, when local control is selected, then relay output is represent alarm output, when remote control is selected, then relay shall respond to the master device to perform open/close command.

### 4.12 Analog output

PMAC770 can add 2 expansion modules for adding analog output function, each module can configure 2 analog outputs, the max output load is 750Ω, output range is 4~20mA, 120% overload limit.

The relative objects for analog output are show as below:

Ua	Ub	Uc	Uab	Ubc	Uca	Frequency
Ia	Ib	Ic	P <sub>t</sub>	Q <sub>t</sub>	PF <sub>t</sub>	

AO calculation formula :

$$K = (\text{Value} - V_{\min}) / (V_{\max} - V_{\min})$$

$$AO = 4 + 16 * K \quad (\text{mA})$$

K: 0-100%

V<sub>max</sub>: max value

V<sub>min</sub>: min value

Value: actual input value

## 4.13 Communication

PMAC770H provides 2 RS485 ports(one is standard, one is optional) and 1 optional Ethernet port.

- 1) RS485 port supports Modbus communication protocol, and settable baud rate including 2400bps, 4800bps, 9600bps, 19200bps, 38400bps
- 2) Ethernet port using standard RJ-45 interface, equip with 10/100M communication speed, and supports Modbus-TCP/IP communication protocol(port number 502)

## 4.14 Timing

PMAC770H supports SNTP network timing and Modbus communication timing,

- 1) SNTP: the device will obtain the high precision real time from Ethernet server(only supported by model with LAN)
- 2) Modbus: master device adjust the system time over writing Modbus register list number.

## 4.15 Store function

PMAC770H provides 128MB storage capacity for storing data including waveform record, SOE record, PQ events etc.

## 4.16 Real-time waveform

PMAC770H provides a real-time waveform display function, waveform including real-time, three-phase current and three-phase voltage.

## Chapter 5. Display and settings

PMAC770H equips with a TFT colorful LCD which with resolution of 320×240.





### 5.1 Button

PMAC770H equips with 4 buttons on front panel, functions of each button are show as below:

Button	Description
“ < ”	Move cursor to left, or turn page to left
“ > ”	Move cursor to right, or turn page to right
“ ↶ ”	Exit to previous menu or cancel the entered value
“ ↷ ”	Enter next menu or confirm the entered value

### 5.2 Indicator light

PMAC770H equips with 4 indicator lights on front panel:

Indicator	Description
	Running status indicator, flashing when device is under normal operation
	Communication status indicator, flashing when series port is under normal communication
	Fault indicator, flashing when the device is faulty
	Pulse output indicator

### 5.3 Settings and display

The device will refresh the page after powering on, and will enter the default main menu after refreshing, the main menu includes 8 sub menus, show as below picture:

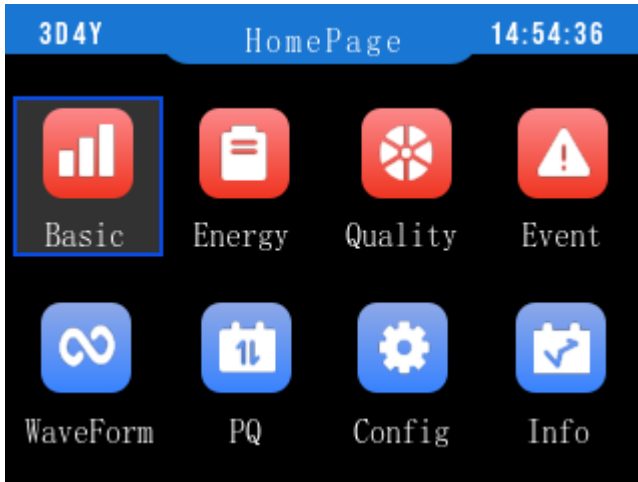

### 5.3.1 Basic measurement

The basic parameter measurement page consists of 11 sub menus, which include phase voltage, line voltage, phase current, active power, reactive power, power factor, frequency, current demand, power demand, digital input, relay etc.

Basic	
V (ph-N)	0.00 v
U (ph-ph)	A 0.00 v
V <sub>n</sub>	B 0.00 v
I	C 0.00 v
P	Avg 0.00 v
Q	
S	

### 5.3.2 Electrical energy measurement

Electrical energy measurement page is consists of 6 sub menus, which including total energy, active energy, reactive energy, apparent energy, four quadrant energy and multi-tariff energy etc. :

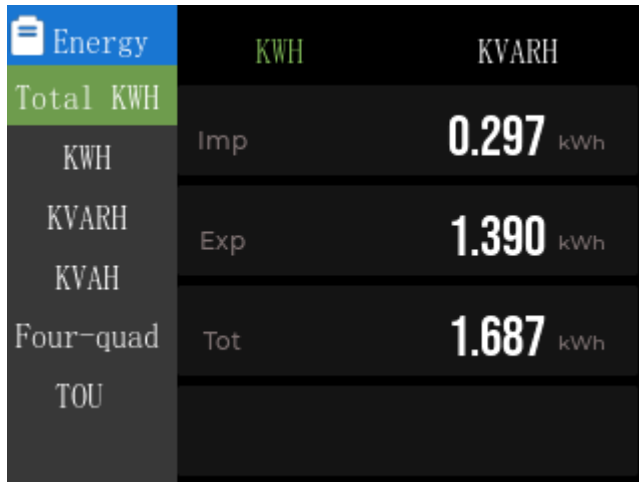

The screenshot shows a user interface for electrical energy measurement. On the left is a vertical menu with options: Energy (highlighted in blue), Total KWH (highlighted in green), KWH, KVARH, KVAH, Four-quad, and TOU. On the right is a data table with a dark background. The table has two columns: 'KWH' and 'KVARH'. The 'KWH' column lists 'Imp', 'Exp', and 'Tot'. The 'KVARH' column shows values '0.297 kWh', '1.390 kWh', and '1.687 kWh' respectively. The 'Tot' row in the 'KWH' column is currently empty.

	KWH	KVARH
Total KWH		
KWH	Imp	0.297 kWh
KVARH	Exp	1.390 kWh
KVAH	Tot	1.687 kWh
Four-quad		
TOU		

### 5.3.3 Power quality

Power quality page is consists of 7 sub menus, which including phase diagram, imbalance rate, sequence components, deviation, crest factor, flicker and current etc.

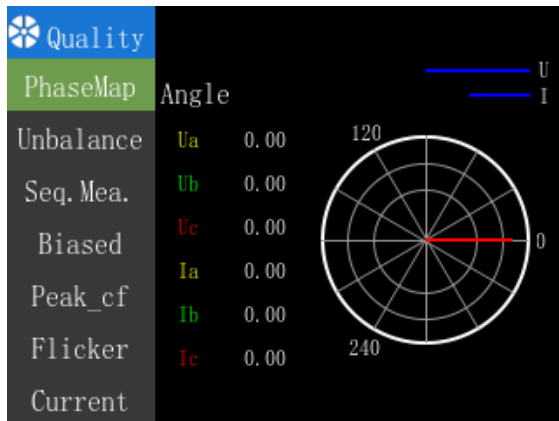

### 5.3.4 Event record

Event record page display the events including phase voltage over limit, phase voltage under limit etc. For more detailed events please refer to parameter settings->alarm setting.

Event		
Order	Time	Type
1	2022/08/01 14:07:52 751	Over U (ph-ph) alarm
2	2022/08/01 14:01:00 361	Over U (ph-ph) recov
3	2022/08/01 13:54:23 672	Over U (ph-ph) alarm
4	2022/08/01 13:54:20 664	Over U (ph-ph) recov
5	2022/08/01 13:53:52 612	Over U (ph-ph) alarm

PageUp PageDown Jump 1/26 Page



Item	Description
Previous page	Turn to previous page
Next page	Turn to next page
Turn to“1/1”page	Turn to specified page, 1/1 : 1: current page 1: total page(s)

### 5.3.5 Real-time waveform

Real-time waveform page including three-phase current and three-phase voltage waveform.

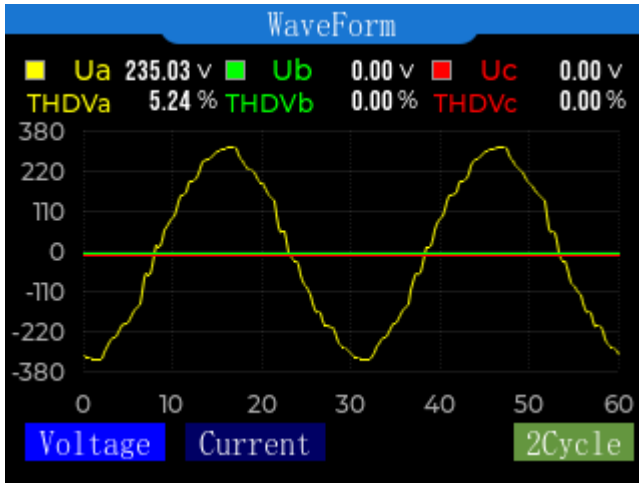

Item	Description	Switching button
Voltage	Voltage secondly value(220V/480V system)	“<” / “>”
Current	Current secondly value	
2 points/cycles	1point/ cycles, 2 points/cycles(default), 4 points/cycles	“←”

### 5.3.6 Waveform recording

Waveform recording function records three phase voltage swell, sag and interruption events.

Event		
Orde	Time	Type
1	2022/08/17 16:59:20 962	Ua Inter
2	2022/08/17 16:59:20 952	Ua Swell
3	2022/08/17 15:08:24 948	Ub Swell
4	2022/08/17 15:08:24 948	Uc Swell
5	2022/08/17 15:08:24 948	Ub Inter
PageUp		PageDown
Jump		1/20 Page

Waveform details can be read by selecting the corresponding event

Item	Description
Previous page	Turn to previous page
Next page	Turn to next page
Turn to "1/26" page	Turn to specified page, 1/26: 1: current page 26: total pages

### 5.3.7 Parameter settings

Please setup the parameters before using the equipment, the default password for performing parameter settings is 01.

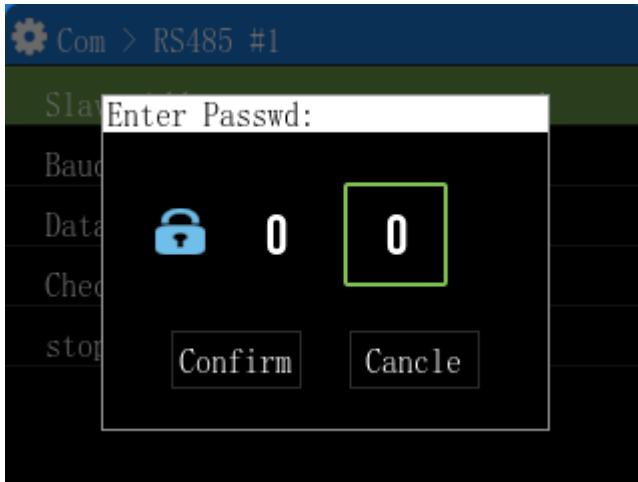

#### 5.3.7.1 Communication setting

Communication setting page shows parameters including Ethernet and 2 RS485 interface info:

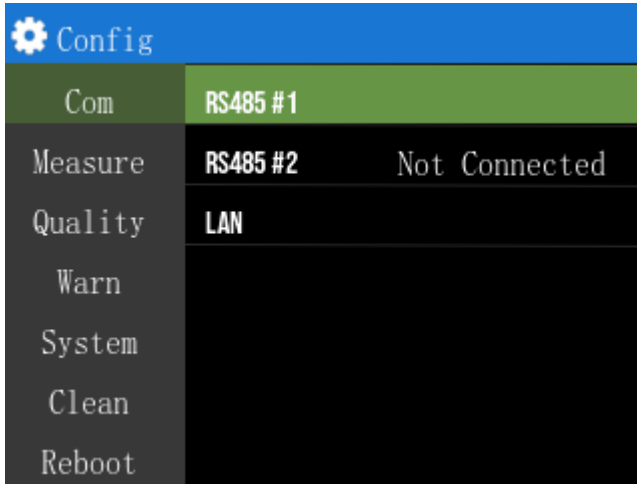

Set via register list	Factory default	Description
<b>RS485#1 setting</b>		
Device ID	1	1 ~ 247, each device shall have a unique ID for devices connected in a same circuit
Baud rate	9600	1200/2400/4800/9600/19200/38400bps
Data bit	8	7 or 8
Parity bit	None	None, Odd, Even
Stop bit	1	1 or 2
<b>RS485#2 setting</b>		

Settings same as <b>RS485#1</b>		
<b>Ethernet setting</b>		
IP	192.168.0.100	The Ethernet parameters setting shall meet below requirements: 1) IP add and sub mask cannot be 0(gateway IP is 0 means no gateway) 2) IP add and gateway should be in range of 1~223 3) IP add and gateway cannot be 127.x.x.x.
Sub mask	255.255.255.0	
Gateway	192.168.0.1	
DNS	8.8.8.8	

### 5.3.7.2 Measurement settings

Measurement settings page is consists of 6 sub menus, which including wiring mode setting, pulse setting, demand setting, AO setting, relay setting and load setting.

 Config	
Com	Wire
Measure	Pulse
Quality	Demand
Warn	AO
System	Relay
Clean	Load
Reboot	

#### 5.3.7.2.1 Wiring mode setting

Wiring mode setting page is used to modify wiring mode, PT ratio, CT ratio etc.

Measure > Wire	
Wire Mode:	3D4Y
PT Ratio:	1.00
CT Ratio:	1.00

Parameters table:

Item	Factory Default	Range
Wiring mode	3P4W	3P4W,3P3W
PT ratio	1.00	1.00-6900.00
CT ratio	1.00	1.00-10000.00

### 5.3.7.2.2 Pulse setting

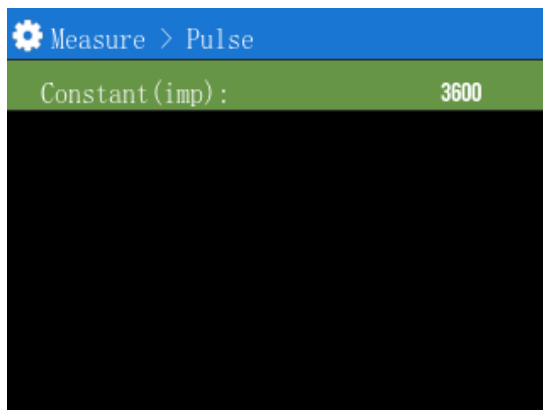

Pulse setting page is mainly used to set pulse constant.

Item	Factory default	Range
Pulse constant (imp)	3600	0-65536

#### 5.3.7.2.3 Demand parameter setting

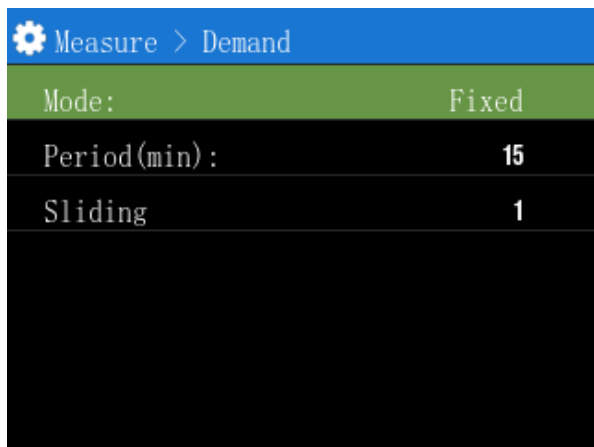

Demand parameter setting page is used to set demand mode, demand cycle and slip width:

Item	Factory default	Range
Demand mode	Fixed mode	Fixed/slip mode
Demand cycle(min)	15	5min/10min/15min/30min/60min
Slid width(min)	1	1min/2min/3min/5min

#### 5.3.7.2.4 AO setting (connect expansion module)

AO setting page including setting for AO1、AO2、AO3、AO4:

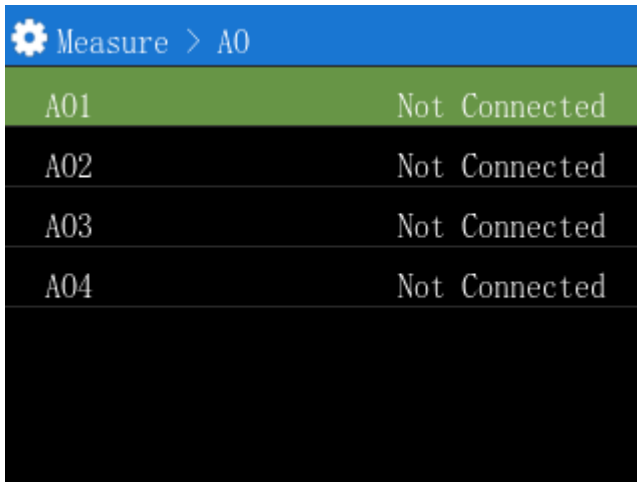

Select the right AO channel and enter the setting page accordingly



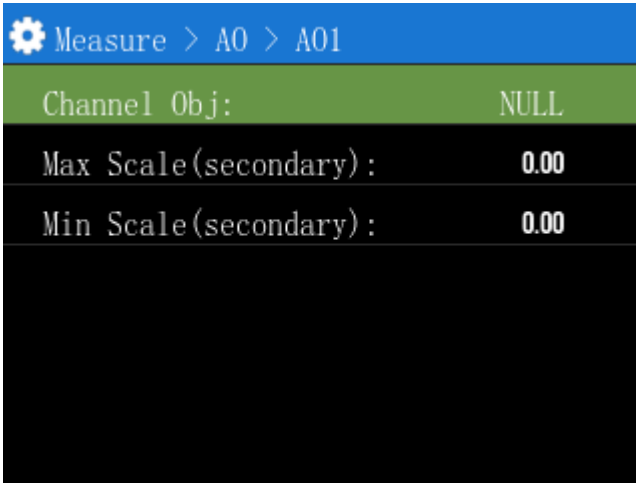

AO parameter setting table:

Item	Factory default	Range
Object	Null	Null/Ua/Ub/Uc/Uab/Ubc/Uca/Ia/Ib/Ic/ P/Q/PF/frequency
Max range(secondly value)	0.00	U/I/frequency: 0.00~9999.99
Min range(secondly value)	0.00	P/Q: -9999.99~9999.99 PF:-1.000~+1.000

### 5.3.7.2.5 Relay setting

Relay setting page is used to setup the relay working mode, when local control is selected, then relay output is represent alarm output, when remote control is selected, then relay shall respond to the master device to perform open/close command.

Measure > Relay	
Relay1:	Local
Relay2:	Local
Relay3:	Local
Relay4:	Local
Relay5:	Local
Relay6:	Local

Setting table:

Item	Factory default	Range
1~6 relay	Local	Local mode or remote mode

#### 5.3.7.2.6 Load setting

Load setting page including upper limit setting for voltage, current and total active power, and lower limit for voltage only.

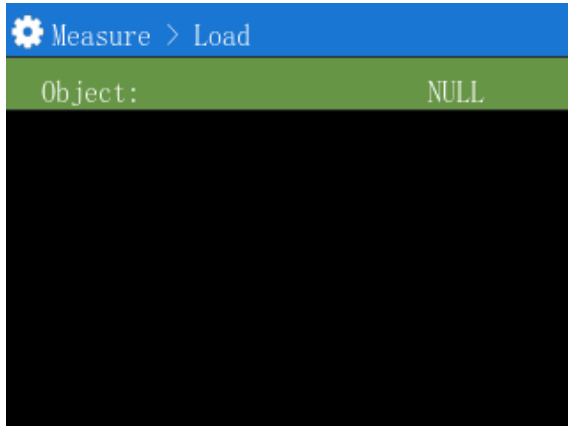

Setting table :

Item	Factory default	Range
Object	Null	Null,voltage,current,total active power
Upper limit	0.00	Voltage: 0.00 - 999.99(kV) Current: 0.00 - 999.99(kA) P <sub>t</sub> : -20MW - 20MW
Lower limit	0.00	Voltage: 0.00 - 999.99(kV)

### 5.3.7.3 Power quality

Power quality page is consists of 4 sub menus, which including voltage swell, voltage sag, voltage interruption and other.

Config	
Com	Vol Swell
Measure	Vol Sag
Quality	Vol inter
Warn	Other
System	
Clean	
Reboot	

#### 5.3.7.3.1 Voltage swell/sag/interruption

This page can be used to set voltage swell, sag and interruption for each phase(Ua,Ub,Uc):

Quality > Vol Swell	
Ua	
Ub	
Uc	

The parameter settings including threshold and hysteresis value :



Setting table:

Item	Factory default	Range
Threshold	220.00V	0-999.99V
Hysteresis	220	0-999

#### 5.3.7.3.2 Other

This page is mainly used to set CO2 emission factor.

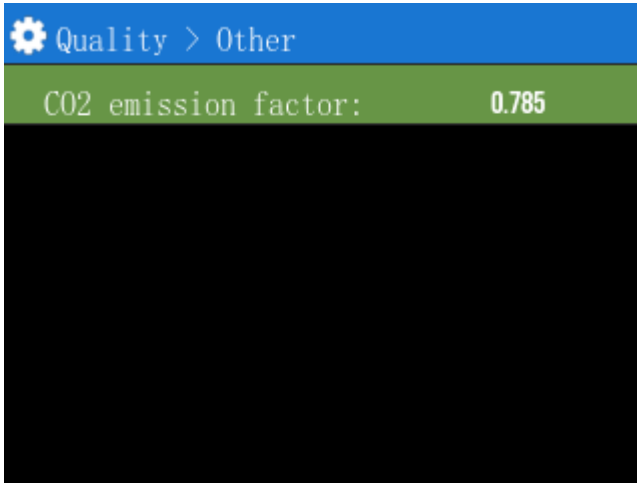

Setting table :

Item	Factory default	Range
CO2 emission factor	0.785	0 - 65.536

#### 5.3.7.4 Alarm setting

Alarm setting page consist of 7 sub menus, they are voltage setting, current setting, frequency setting, power setting, imbalance setting, harmonic distortion setting and other settings.

Config	
Com	Voltage
Measure	Current
Quality	Hz
Warn	Power
System	Unbalance
Clean	Distortion
Reboot	Other

#### 5.3.7.4.1 Voltage setting

Voltage setting page including 11 sub setting menus for phase voltage over limit, phase voltage lower limit, average phase voltage over limit, average phase voltage over limit, line voltage over limit, line voltage lower limit, average line voltage over limit, average line voltage lower limit, neutral line to ground voltage over limit, neutral line to ground voltage lower limit, voltage loss etc.

Warn > Voltage
over_VIn
under_VIn
over_VInAvg
under_VInAvg
over_VI1
under_VI1

Voltage parameters setting show as below:

Voltage > over_VIn	
Enable:	Open
Relevancy:	NULL
Threshold (V):	<b>0.00</b>
Retention(S):	<b>100</b>
Hysteresis (V):	<b>0.00</b>



Setting table:

Item	Factory default	Range
Enable	Off	On or off
Relative	None	None/R1/R2/R3/R4/R5/R6(R stands for relay)
Threshold(V,kV)	1.00	0.00 - 999.99(kV)
Hold time(S)	0	0 - 999
Hysteresis (V)	0	0.00-655.35

#### 5.3.7.4.2 Current setting

Current setting page including 6 sub setting menus for current over limit, current lower limit, neutral line current over limit, neutral line current lower limit, average current over limit, average current lower limit.

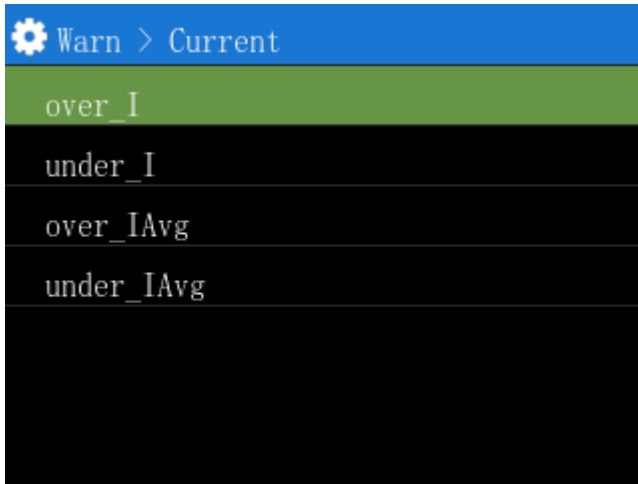

Current parameters setting show as below :

Current > over_I	
Enable:	Open
Relevancy:	NULL
Threshold (A):	0.00
Retention(S):	0
Hysteresis (A):	0.00

Setting table:

Item	Factory default	Range
Enable	Off	On or off
Relative	None	None/R1/R2/R3/R4/R5/R6(R stands for relay)
Threshold(A,kA)	1.00	0.00 - 999.99(kA)
Hold time (S)	0	0 - 999
Hysteresis (A)	0	0.00-65.53

#### 5.3.7.4.3 Frequency setting

Frequency setting page including upper and lower limit setting for frequency parameter.

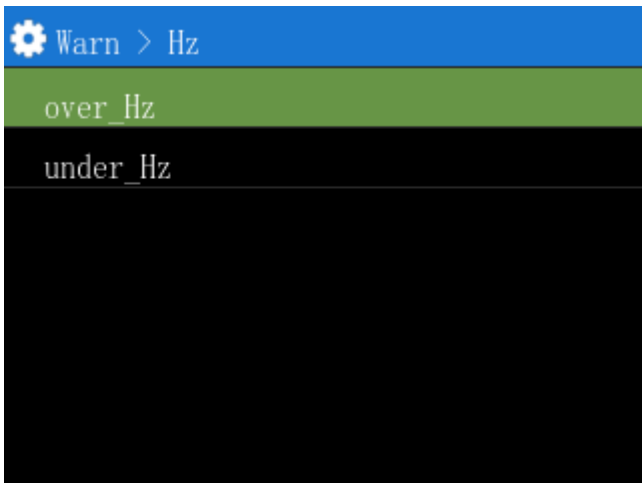

Frequency parameter setting show as below :

A screenshot of a settings menu for "Hz > over\_Hz". The top bar is blue with a gear icon and the text "Hz > over\_Hz". Below this, there are five rows of settings, each with a green bar on the left and a black bar on the right. The settings are: "Enable:" with value "Open", "Relevancy:" with value "NULL", "Threshold (Hz):" with value "0.00", "Retention(S):" with value "0", and "Hysteresis (Hz):" with value "0.00".

Enable:	Open
Relevancy:	NULL
Threshold (Hz):	<b>0.00</b>
Retention(S):	<b>0</b>
Hysteresis (Hz):	<b>0.00</b>

Setting table:

Item	Factory default	Range
Enable	Off	On or off
Relative	None	None/R1/R2/R3/R4/R5/R6(R stands for relay)
Threshold (pf)	1.00	0.00 - 999.99
Hold time (S)	0	0 - 999
Hysteresis (%)	0	0.00-655.35

#### 5.3.7.4.4 Power setting

Power setting page is consists of 17 sub menus, which including active power upper limit, active power lower limit, total active power upper limit, total active power lower limit, reactive power upper limit, reactive power lower limit, reactive power lower limit, total reactive power upper limit, total reactive power lower limit, apparent power upper limit, apparent power lower limit, total apparent power upper limit, total apparent power lower limit, power factor upper limit, power factor lower limit, total power factor upper limit, total power factor lower limit, total active power demand upper limit etc.

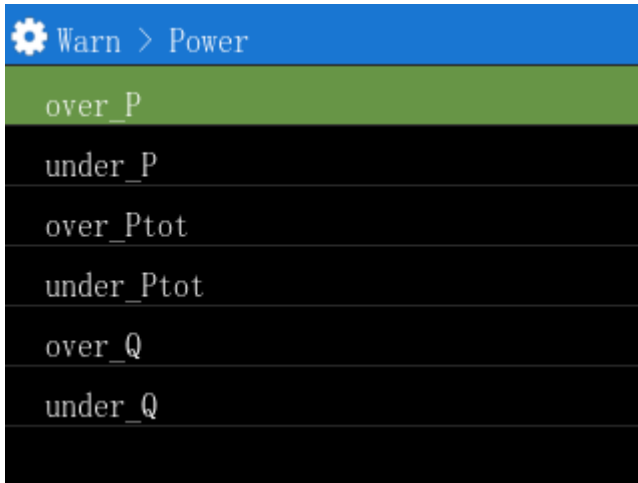

Power alarm settings page is show as below:

Power > over_P	
Enable:	Open
Relevancy:	NULL
Threshold (W) :	0.00
Retention(S) :	0
Hysteresis (W) :	0.00

Active power setting table(reactive power setting same as this part):

Item	Factory default	Range
Enable	Off	On or off
Relative	None	None/R1/R2/R3/R4/R5/R6(R stands for relay)
Threshold(W,kW,MW )	1100.00	-20MW - 20MW
Hold time (S)	0	0 - 999
Hysteresis (W)	0	0 - 655.35

Apparent power setting table:

Item	Factory default	Range
Enable	Off	On or off
Relative	None	None/R1/R2/R3/R4/R5/R6(R stands for relay)
Threshold(VA,kVA,M VA)	1100.00	0 - 20MVA
Hold time (S)	0	0 - 999
Hysteresis (VA)	0	0 - 655.35

Power factor setting table:

Item	Factory default	Range
Enable	Off	On or off

Relative	None	None/R1/R2/R3/R4/R5/R6(R stands for relay)
Threshold(pf)	0	-1.00 - 1.00
Hold time (S)	0	0 - 999
Hysteresis (pf)	0	0 - 1.00

#### 5.3.7.4.5 Imbalance rate setting

Imbalance rate setting page is consists of 4 sub menus, which including negative sequence voltage imbalance rate upper limit, negative sequence current imbalance rate upper limit, zero sequence voltage imbalance rate upper limit, zero sequence current imbalance rate upper limit.

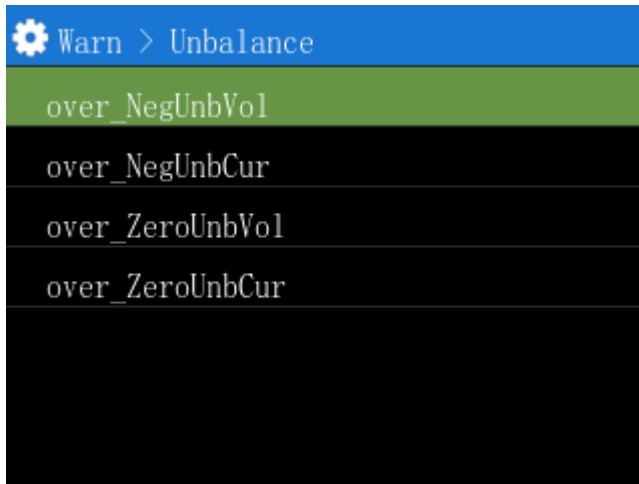

Imbalance rate alarm parameter setting page show as below:

Unbalance > over_NegUnbVol	
Enable:	Open
Relevancy:	NULL
Threshold (%) :	0.00
Retention(S) :	0
Hysteresis (%) :	0.00

Setting table:

Item	Factory default	Range
Enable	Off	On or off
Relative	None	None/R1/R2/R3/R4/R5/R6(R stands for relay)
Threshold(%)	0	0 - 100.00
Hold time(S)	0	0 - 999
Hysteresis (%)	0	0 - 100.00

#### 5.3.7.4.6 Harmonic distortion setting

Harmonic distortion setting page is consists of 14 sub menus, which including voltage THD upper limit, current THD upper limit, voltage 3<sup>rd</sup> harmonic upper limit, voltage 5<sup>th</sup> harmonic upper limit, voltage 7<sup>th</sup> harmonic upper limit, voltage 9<sup>th</sup> harmonic upper limit, voltage 11<sup>th</sup> harmonic upper limit, voltage 13<sup>th</sup> harmonic upper limit, current 3<sup>th</sup> harmonic upper limit, current 5<sup>th</sup> harmonic upper limit, current 7<sup>th</sup> harmonic upper limit, current 9<sup>th</sup> harmonic upper limit, current 11<sup>th</sup> harmonic upper limit, current 13<sup>th</sup> harmonic upper limit etc.

Warn > Distortion	
over_THDV	
over_THDI	
over_HD3V	
over_HD5V	
over_HD7V	
over_HD9V	

Harmonic distortion alarm setting page is show as below :

Distortion > over_THDV	
Enable:	Open
Relevancy:	NULL
Threshold (%) :	<b>0.00</b>
Retention(S) :	<b>0</b>
Hysteresis (%) :	<b>0.00</b>



Setting table:

Item	Factory default	Range
Enable	Off	On or off
Relative	None	None/R1/R2/R3/R4/R5/R6(R stands for relay)
Threshold (%)	0	0 - 100.00
Hold time (S)	0	0 - 999
Hysteresis (%)	0	0 - 100.00

#### 5.3.7.4.7 Other settings

Other settings page is consists of 15 sub menus, which including DI1 open, DI2 open, DI3 open, DI4 open, DI5 open, DI6 open, DI7 open, DI8 open, DI9 open, DI10 open, DI11 open, phase voltage deviation upper limit, line voltage deviation upper limit, frequency deviation upper limit, phase voltage deviation rate etc.

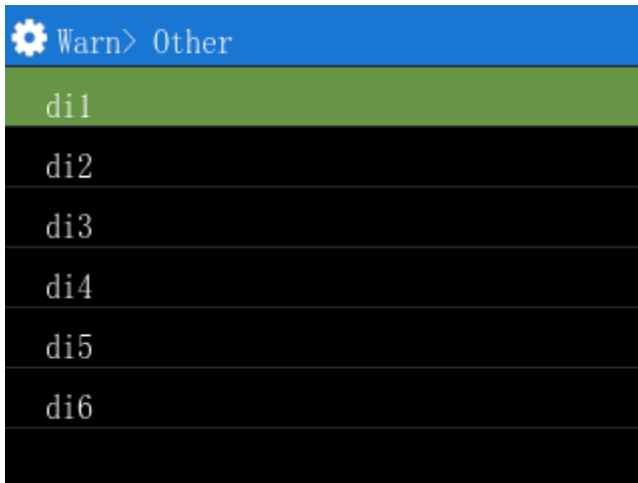

DI parameter setting page :



Setting table:

Item	Factory default	Range
Enable	Off	On or off
Relative	None	None/R1/R2/R3/R4/R5/R6(R stands for relay)
Threshold	open	Open or close

### 5.3.7.5 System settings

System settings page including 3 sub setting menus, they are working mode setting, 系统 time setting and language setting.

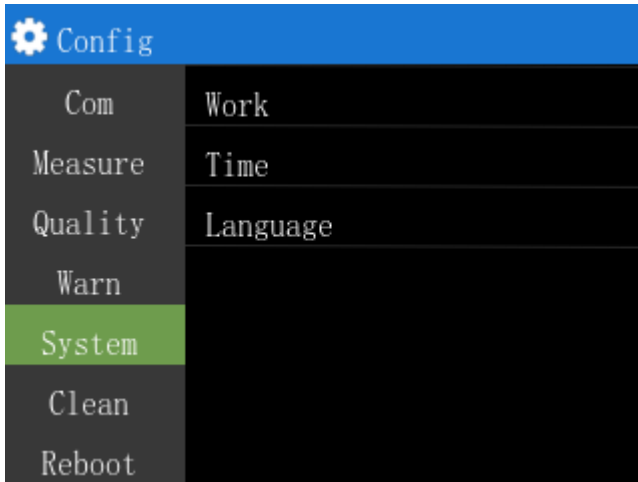

#### 5.3.7.5.1 Working mode setting

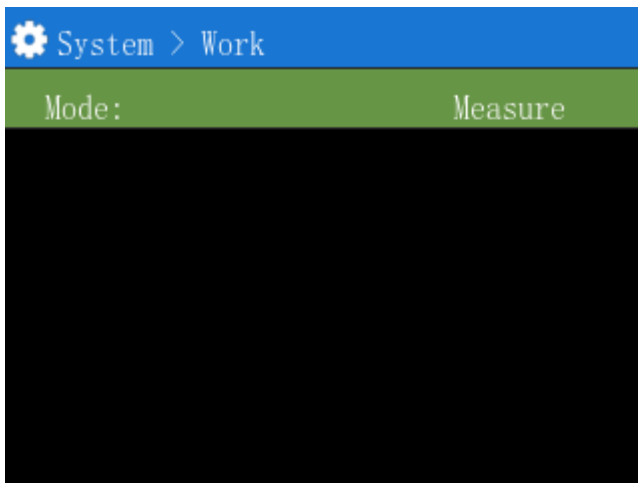

Setting table:

Item	Factory default	Range
Mode	Measurement mode	Measurement mode, commissioning mode

### 5.3.7.5.2 Time setting

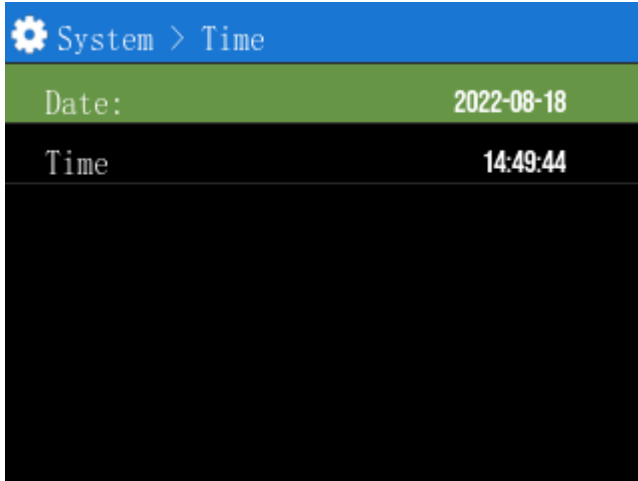

Setting table:

Item	Factory default	Range
Date	Current date(factory calibrated)	2022-01-01 - 2099-01-01
Time	Current time(factory calibrated)	00:00:00-23:59:59

### 5.3.7.5.3 Language setting

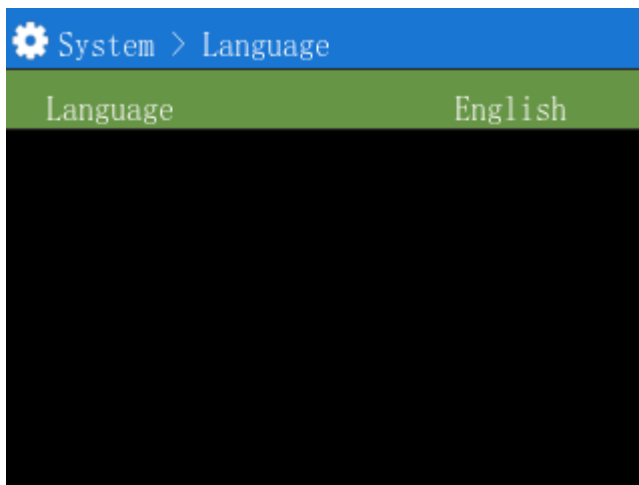

Setting table:

Item	Factory default	Range
Language	Chinese	Chinese or English

### 5.3.7.6 Clear record

Clear record page including user parameter and demand extreme value 2 sub menus :

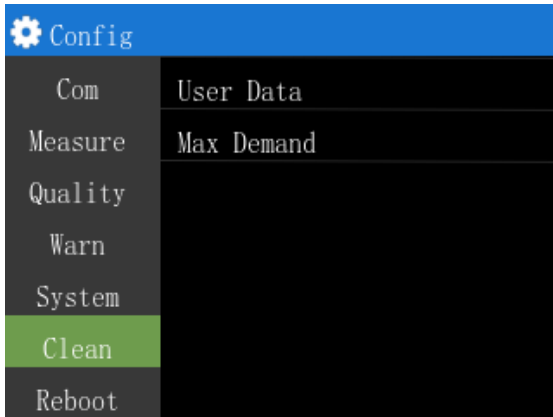

#### 5.3.7.6.1 User parameter

User parameter clear page is show as below, a password is needed to proceed the operation, the default password is 888.

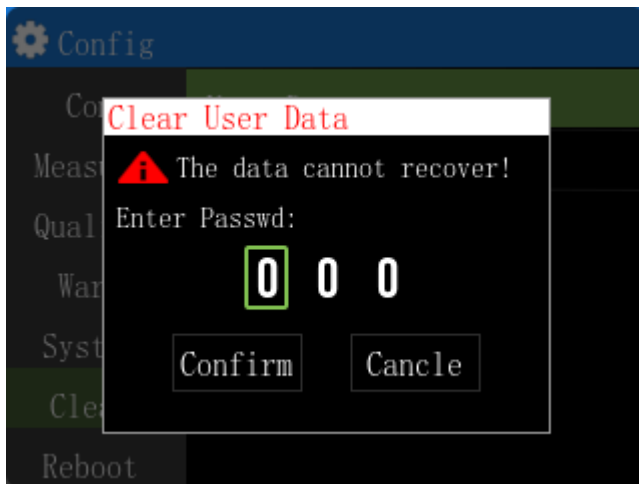

#### 5.3.7.6.2 Demand extreme value

Demand extreme value clear page is show as below, a password is needed to proceed the

operation, the default password is 888.

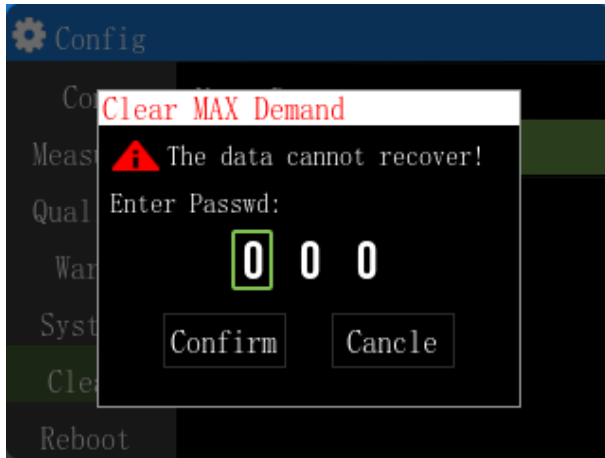

### 5.3.7.7 System reboot

A password is needed for proceeding system reboot operation, the default password is 888.

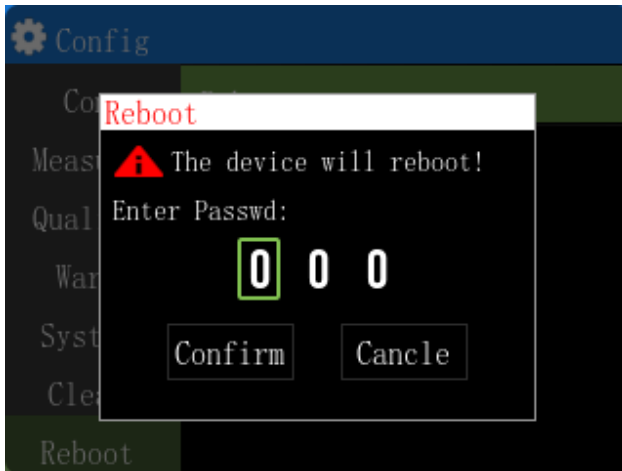

### 5.3.8 System info

Info	
Device	Name: PMAC770H
OS	Model PMAC770-H-NULL-NULL-LAN
	SN: PMAC123456789
	SoftVersion: v1.2.0r0880
	MAC: 00:e0:99:4f:45:fa
	Vender: Pilot Technology co.ltd

Item	Contents
Device state	Product name, model, SN, software version, MAC add, manufacturer info
System state	Operation system, CPU, running time, RAM,ROM, system temperature



## Chapter 6. Technical specification

### 6.1 Device parameters

PMAC770H meets standard of GB/T 17215.321-2021 for static meters for active energy class D requirement, and meets the standard of GB/T 19862-2016 for general requirements for monitoring equipment of power quality.

Measured parameters		Display	Communication	Accuracy
<b>Power quality parameters</b>				
Rapid voltage change	Voltage	Event	Event	
Voltage deviation	Voltage	%	%	0.1%
Frequency deviation	Frequency	-	-	0.01Hz
Imbalance rate	Voltage, current	Primary value	Primary value	S class
Harmonic ratio	63 <sup>rd</sup> voltage/current harmonic components	%	%	S class
Harmonic power	63 <sup>rd</sup>	Primary value	Primary value	S class
Harmonic RMS	63 <sup>rd</sup> voltage/current harmonic components	Primary value	Primary value	S class
Harmonic distortion rate	Total/odd/even harmonic distortion rate	%	%	S class

Flicker	Voltage	-	-	5%
<b>Real-time RMS</b>				
U	Phase/line/average	Primary value	Primary value	0.1%
I	Phase/zero sequence/average	Primary value	Primary value	0.1%
P	Single/three phase	Primary value	Primary value	0.2%
Q	Single/three phase	Primary value	Primary value	0.5%
S	Single/three phase	Primary value	Primary value	0.2%
PF	Single/three phase	Primary value	Primary value	0.2%
Active energy	Single phase/import/export/total	Primary value	Primary value	0.2S class
Reactive energy	Single phase/import/export/total	Primary value	Primary value	2 class
Extreme value	Phase voltage/phase current/total active power/total reactive power	Primary value	Primary value	—
Demand	Three phase current/total active power/total reactive power/total apparent power	Primary value	Primary value	—
Multi-tariff	Import and export	Primary value	Primary value	—

Frequency	Frequency	Primary value	Primary value	0.01Hz
<b>Communication</b>				
2 RS485 ports, 1 10/100M Ethernet port				
<b>Relay output</b>				
4 normal open relays				
<b>Digital input</b>				
8 active digital inputs or 8 passive digital inputs				
<b>Pulse output</b>				
2 settable pulse outputs for active energy and reactive energy( secondly full wave energy pulse)				
<b>Clock</b>				
Device local clock(0.5s/day)				

## 6.2 Performance specification

	Parameter	Range
<b>Rated parameters</b>	Working power supply	AC85~265V, DC100~300V
	Power consumption	< 10VA
	Overload capacity	2 times of voltage continuous, 4 times/1s 4times of current continue, 10 times/1s
	Digital input	Active: outer power supply 220Vac±35% or 220Vdc±35% Passive: internal power supply 30VDC
	Relay output	250Vac/5A or 30Vdc/5A
	<b>parameter</b>	<b>Performance</b>
<b>Insulation</b>	Power frequency withstand voltage	AC2kV/Min~1mA
	Insulation resistance	≥100MΩ

	Impulse voltage	6kV(peak value), 1.2/50 $\mu$ s	
	<b>Item</b>	<b>Standard</b>	<b>Test level</b>
<b>IEC</b>	Electrostatic discharge immunity	GB/T17626.2-2006 (IEC61000-4-2:2001)	Class 4
	Radio frequency electromagnetic field radiation immunity	GB/T17626.3-2006 (IEC61000-4-3:2002)	Class 3
	Electrical fast transient burst immunity	GB/T17626.4-2008 (IEC61000-4-4:2004)	Class 4
	Surge immunity	GB/T17626.5-2008 (IEC61000-4-5:2005)	Class 4
	Conducted disturbance immunity of RF field induction	GB/T17626.6-2008 (IEC61000-4-6:2006)	Class 3
	Power frequency magnetic field immunity	GB/T17626.8-2006 (IEC61000-4-8:2001)	Class 4
	Voltage dip, short-term interruption immunity	GB/T17626.11-2008 (IEC61000-4-11:2004)	Comply
	Electromagnetic disturbance limit	GB 4824-2013 (CISPR11: 2010)	Comply

## Chapter 7. Maintenance and troubleshooting

Issue	Cause	Solution
No display after powering on	Device power on failed	Check if terminal L/+ and N/- are connected with a right rated power supply. Check if the fuse has been burned down
Incorrect measurements	Incorrect voltage measurement	Check if the neutral line connection is well Check if the measured voltage is matched to the rated parameter Check if the PT setting is right
	Incorrect current measurement	Check if the measured current is matched to the rated parameter Check if the CT setting is right
	Incorrect power measurement	Check if the measurement mode setting is right Check if the phase sequence correspondence between voltage and current is right Check if the current homonymous ends are wrong
DI state no change	DI action voltage is not correct	Check if the external contact type is compatible with the rated input parameter Check if the external wiring is well
Relay no action	No control command is received	Check if the communication circuit connection is well
	Relay working mode is not correct	Check if the current relay is under a right working mode
Master device cannot	Device ID is not correct	Check if the device ID is same as defined

communicate with the meter	Device baud rate is not correct	Check if the device baud rate is same as defined
	Resistance did not connect to communication end	Check if the 120Ω resistance has been connected to the communication circuit
	Interference with the communication circuit	Check if the communication shielded twisted pair connection is well
	Communication circuit interrupted	Check if the communication circuit is disconnect

**ЭНЕРГОМЕТРИКА**  
[www.energometrika.ru](http://www.energometrika.ru)

---