



CATALOGUE

MAKE ENERGY USAGE SMARTER





Table Of Content

About Accuenergy	4
Accuenergy Meters	6
Acuvim II - Advanced Multi-Function Power & Energy Meter Series	6
Acuvim II - Expansion Modules.....	8
Acuvim II + AXM-WEB2.....	9
Acuvim-L - Standard Multi-Function Power & Energy Meter Series	10
AcuRev 1310 - DIN-Rail Digital Panel Meter.....	12
EV300 - Panel Meter Series.....	14
AcuPanel 9100 - Pre-Wired Metering Panels.....	16
AcuRev 2100 - Multi-Circuit Submeter with SnapOn CT Technology	18
AcuDC 240 - DC Energy Meter.....	20
Communications & Software Solutions	22
AcuCloud - Cloud-Based Metering Platform	22
AcuLink 810 - Data Acquisition Gateway.....	24
AcuMesh - Wireless RS485 Metering Network	26
Current Transformers	27
AcuCT Flex - Rogowski Coils.....	27
RIK Series - Rogowski Integrator Kit.....	28
AcuCT R - Revenue-Grade Split-Core Current Transformer.....	29
AcuCT mV - 333mV Split-Core Current Transformer	29
AcuCT 5A - 5A Split-Core Current Transformer	30
AcuCT Hinged - 5A Split-Core Current Transformer	30
AcuCT S113 - Solid-Core Current Transformer	31
AcuCT S77 - Revenue-Grade Solid-Core Current Transformer	31
AcuCT S220 - Switchgear Solid-Core Current Transformer	32
AcuCT S335 - Busbar Solid-Core Current Transformer	32
AcuCT S433 - Instrument Solid-Core Current Transformer.....	33
AcuCT S650 - Solid-Core Current Transformer	33
HAB 16555 - DC Current Sensors	34
HAK - Hall Effect Current Sensors.....	34
HV2 - DC Voltage Sensor	35
DC Shunts - Shunt Series	35
AcuCT C - Current Transformer Converter	36

We Are Accuenergy

Accuenergy Inc. specializes in power metering solutions that lead the industry in revenue grade energy metering, power quality analysis, ease of deployment and advanced communication methods. Our reliable power meters have been used globally to monitor electrical systems in commercial and industrial facilities, multi-tenant buildings, data centres, and cell towers for more than 20 years.

Our goal is to provide users with well-designed products that are easy to implement without sacrificing key functionality. Our pre-wired panel meters and wireless submeters are designed to offer the simplest tenant billing and metering solutions on the market, while providing ease of installation.







ACUVIM II



Advanced Multi-Function Power & Energy Meter Series

The Acuvim II series energy submeters are the simple, robust solution for power monitoring, power quality analysis, kW metering, and more. Designed for easy integration in almost any metering application, a wide array of plug-in expansion modules allows communication on over 15 different industry-standard protocols.

ACCUENERGY.COM/ACUVIM-II



EN55011



Key Specifications

- Revenue grade ANSI C12.20 Class 0.2 & IEC 62053-22 Class 0.2s
- Built-in Modbus-RTU and BACnet-MS/TP via RS485 port
- Expand with dual RJ45, WiFi, Fiber optic, Profibus and more interfaces
- Add up to three I/O expansion modules
- MV90 compatibility
- Datalogging with up to 50ms logging interval and graphical trending analysis*
- COMTRADE Waveform file format*
- Threshold alarms can be set to notify users of potential issues
- Time-of-Use (TOU) capability allows time-based or tier-based rate structure*
- Support BACnet, SNMP, EtherNet/IP, IPv6, RSTP, HTTPS,sFTP, MQTT and more protocols for integration
- Cloud metering data storage & analytics

**Selected models only*

PRODUCT COMPATIBILITY



ACUMESH



**ACUPANEL
COMPATIBLE
METER**



ACUCLOUD

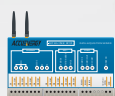

ACULINK 810

Data Logging

Essential to trend analysis and reporting, the Acuvim IIR and IIW offer a robust data logging feature where most metering parameters can be recorded for later review. The integrated real-time clock ensures logged events are accurately time stamped. 8MB of non-volatile memory is built into the meter and, by equipping the AXM-WEB2 module, an additional 8GB of memory with up to a 50ms logging interval is made available.

Anti-Tampering Seal

Much like a utility meter, the Acuvim II can be physically sealed to protect against tampering. All metrological programming and user-defined parameters are safeguarded with the physical seal.

Alarms

Quickly set over or under limit alarms for up to 16 indicated parameters with a specified time interval. If a parameter goes outside its setting limit, the alarm output is triggered, and the event is recorded with a time and date stamp for later analysis. Easy to manage and customize, the alarm can be configured using any of 80 available parameters.

Power Quality Monitoring

Power quality monitoring ensures systems run at maximum efficiency. The Acuvim IIW can detect energy deviations using harmonic analysis, event logging, and waveform capture. Facility managers can use the detailed PQ data to diagnose power quality issues before they result in system inefficiency.

Waveform Capture

The Acuvim IIW can record 100 groups of voltage and current waveforms. The instrument supports a settable triggering condition and provides a waveform record of 10 cycles before and after each triggering point. Data can be stored in the COMTRADE waveform file format for later analysis.

Time-Of-Use

Time-based tariffs can lead to higher power bills when energy-intensive devices are run during peak hours. Time-of-use metering allows facility managers to reduce energy costs where TOU rates have been applied. Gain valuable insight into a facility's load profile with built-in peak analysis tools.

AXM-DIN Rail Mounting Adapter

The AXM-DIN Rail Adapter is the easy solution for panel-mount Acuvim II series meters on either horizontal or vertical DIN rail.



IP66/NEMA4X Adapter Protection Cover

Defend against dust, water, or other contaminants: The Protection Cover is designed for all Acuvim II panel meters. It increases the IP environmental rating of a meter's display to IP66 or NEMA 4X.



Acuvim II Series Models

	Acuvim IIR	Acuvim IIW
Application	Billing / Data Logging	Power Quality
Metering	400 Parameters	400 Parameters
Data Logging	•	•
Onboard Memory	8MB	16MB
With AXM-WEB2	8GB	8GB
Time-of-Use	•	
Power Quality		•



EXPANSION MODULES

Snap-On Communication Modules for Acuvim II Series Meters



Acuvim II Communication Modules

The AXM modules are designed to expand the communication capabilities of the Acuvim II meter. Easy to deploy, the field-expandable modules connect directly to the meter to boost the number of compatible communication protocols or increase the number of I/O ports.



ACCUENERGY.COM/AXM-MODULES

I/O Modules

	AXM-IO1	AXM-IO2	AXM-IO3
Digital Input	6	4	4
Digital Output	-	2	-
Relay Output	2	-	2
Analogue Inputs	-	-	2
Analogue Outputs	-	2	-

Acuvim II AXM Expansion Modules

	Meter Only	AXM WEB2 FOLC	AXM WEB2	AXM WEB PUSH	AXM PROFI	AXM RS485
Modbus-RTU	•					•
BACnet-MS/TP	•					
DNP 3.0 Over IP		•	•	•		
IEC 61850		•	•			
Modbus-TCP/IP		•	•	•		
HTTP/HTTPs Webserver		•	•	•		
SMTP Email		•	•	•		
SNMP V3		•	•	•		
MQTT		•	•			
EtherNet/IP, RSTP, IPv6		•	•			
HTTP/HTTPs Push		•	•	•		
FTP Post		•	•	•		
sFTP Server		•	•	•		
Datalogging		8GB	8GB	4GB		
BACnet-IP		•	•			
PROFIBUS					•	
WiFi		•	•			
RJ45 Ports		2	1	1		
Fiber Optics LC		•				



ACUVIM II +

AXM-WEB2 • **AXM-WEB2 FOLC**

WiFi + Dual Ethernet WiFi + Ethernet + Fiber Optics LC

[ACCUENERGY.COM/AXM-WEB2](http://accuenergy.com/axm-web2)

[ACCUENERGY.COM/AXM-WEB2-FOLC](http://accuenergy.com/axm-web2-folc)



AXM-WEB2

AXM-WEB2 FOLC

Key Specifications

- Graphical display for easy analysis
- Metered data is backed up in 8GB non-volatile memory
- RJ45 daisy chain up to 32 devices using dual Ethernet ports
- Maintain high availability with RSTP
- Industry-leading 40ms response rates via Modbus TCP/IP
- Custom Modbus register list groups key parameters
- Compliant with industry-standard security protocols
- IPV6 & IPV4 dual IP network support
- Over-the-air (OTA) firmware updates
- Easy integration with Allen Bradley & Rockwell systems

Web Interface Provides Remote Access

Take full control of the Acuvim II power meter through the web browser interface. Access complete energy from anywhere in the world. Manage and update meter configuration settings including 16 over/under alarm settings. Two-tier user control settings ensure reliable access without compromising meter security.

Flexible Communication Support

Designed to securely meet a wide range of industrial communication requirements, each module is equipped with both Ethernet and WiFi channels. Additionally, the AXM-WEB2 FOLC includes a fiber optic LC port for fast, reliable signal transmission. Communication ports can be utilized simultaneously across different networks or data acquisition systems.

IEC 61850 Certification

The Acuvim IIV power meter with AXM-WEB2/AXM-WEB2 FOLC communication module has been 3rd party certified to meet stringent IEC 61850 (2nd ed.) requirements for seamless deployment in substations and other critical facilities.

Data Logging & Event Storage

The AXM-WEB2 module expands the meter's memory to an industry-leading 8GB with 50ms interval datalogging. Most metering parameters can be recorded for later download or analysis.



Datalogging and Event Storage



WPA2 Enterprise security protocol



Access anywhere via SerialNumber.accuenergy.io



COMtrade Waveform Format

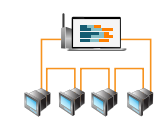

Daisy-chain support via Ethernet ports,

ACUVIM-L



PRODUCT UPDATE

Standard Multifunction Power & Energy Meter Series

The Acuvim-L is a cost-effective power meter that offers performance and value for standard metering solutions. Designed to be easily integrated in panels, as a DIN rail transducer, or as a pre-wired panel. Ideal for a variety of different industrial & commercial applications.

ACCUENERGY.COM/ACUVIM-L



EN55011



Key Specifications

- Revenue grade: ANSI C12.20 class 0.2 & IEC 62053-22 class 0.2s
- 4th CT input – measure neutral current
- Dual Ethernet ports with both RSTP bridge daisy-chain mode and separately configurable network
- Remote channel mapping and four channel multi-circuit metering
- Dual source meter to monitor energy usage from separate energy sources
- Data Logging available in 8MB onboard and 8GB with WEB2 module
- Designed with industry leading cybersecurity
- Available compatibility with multiple CT output options including 5A, RCT (Rogowski), or 333mV
- Modbus-RTU & BACnet MS/ TP ready. Optional modules add support for multiple industrial protocols & interfaces such as Modbus- TCP/IP, BACnet-IP, IEC61850, EtherNet/IP and WiFi

* Selected models only.

PRODUCT COMPATIBILITY



ACUPANEL
COMPATIBLE
METER



Modbus, BACnet with PROFIBUS Option

The Acuvim-CL and EL meters are equipped with Modbus-RTU & BACnet-MS/TP protocol, allowing for interoperability between devices that utilize serial communication. Through an expansion module, add optional PROFIBUS protocol ideal for factory automation systems.

Data Logging

Acuvim-L meters offer three, assignable historical logs and a real time clock to record metering parameters with accurate timestamping. Add the AXM-WEB2 module to expand the memory to 8GB with an adjustable log size.

Time-of-Use (TOU)

Users can assign up to four tariffs (sharp, peak, valley, & normal) to different time periods within a day, as well 12 seasons, and 14 schedules. The Acuvim-L meter will calculate and accumulate energy to different tariffs according to the meter's internal clock and TOU settings.

Alarms

Limits can be set for up to 16 indicated parameters with a specified time interval. Parameters that are over or under setting limit and persist longer than the specified time interval will be recorded and trigger the Alarm DO. Choose from 80 available parameters.

AXM-DIN Rail Mounting Adapter

The AXM-DIN Rail Adapter is the easy solution for panel-mount Acuvim-L series meters on either horizontal or vertical DIN rail.



IP66/NEMA4X Adapter Protection Cover

The protection cover is designed to defend against dust, water, or other contaminants. It increases the IP environmental rating of a meter's display.



Communication Module Comparison

	Meter Only	AXM WEB2 FOLC	AXM WEB2	AXM PROFI	AXM RS485
Modbus-RTU	•				•
BACnet-MS/TP	•				
DNP 3.0 Over IP		•	•		
IEC 61850		•	•		
Modbus-TCP/IP		•	•		
HTTP/HTTPs Webserver		•	•		
SMTP Email		•	•		
SNMP V3		•	•		
EtherNet/IP		•	•		
MQTT		•	•		
RSTP		•	•		
IPv6		•	•		
HTTP/HTTPs Push		•	•		
FTP Post		•	•		
sFTP Server		•	•		
Datalogging	8MB	8GB	8GB		
BACnet-IP		•	•		
PROFIBUS				•	
WiFi		•	•		
RJ45 Ports		1	2		
Fiber Optics LC		•			

Acuvim-L Series Models

	CL	EL
Metering	Voltage (V), Current (Amp), Power (kW)	Voltage (V), Current (Amp), Power (kW)
Energy & Demand	•	•
Time-of-use	•	•
Accuracy	0.5%	0.2%
Power Quality Individual Harmonics	2 nd to 31 st	2 nd to 63 rd



ACUREV 1310



DIN-Rail Digital Panel Meter

The AcuRev 1310 combines high performance with easy integration to provide a cost-effective power and energy monitoring solution for three-phase AC systems. It's robust design features a built-in LCD, Modbus-RTU communications, and 4 current input channels.

ACCUENERGY.COM/ACUREV-1310



Key Specifications

- Utility revenue grade accuracy - IEC 62053-22 0.5s Class / ANSI C12.20 0.5 Class
- Measurement Canada approved
- Compatible with a variety of CT options: 5A/1A, 333mV, Flexible Rogowski Coil, and 80/100/200mA
- 4 Channel current input including neutral current measurement
- Residual current measurement available
- 10-690Vac direct voltage input; fits all voltage rating system with one model
- Integrated RS485 port with Modbus-RTU and BACnet MS/TP for communication with most systems.
- Standard DIN-rail mount for ease-of-installation
- Compatible with both 50Hz and 60Hz systems
- Built-in energy pulse output and alarm output
- Optional relay output for alarm and remote control

PRODUCT COMPATIBILITY



4 Channel CT Input

Accurately measure neutral current with 4th CT channel to provide residual current measurement.

Auto Phase-Check

Designed to automatically check most common wiring mistakes including CT orientation, as well as voltage and current phase alignment.

Supports All Electrical Systems

Monitor a variety of electrical systems including three-phase three wire (3P3W), three-phase four-wire (3P4W), single-phase three-wire (1P3W two element), single-phase two-wire (1P2W one element), and more.

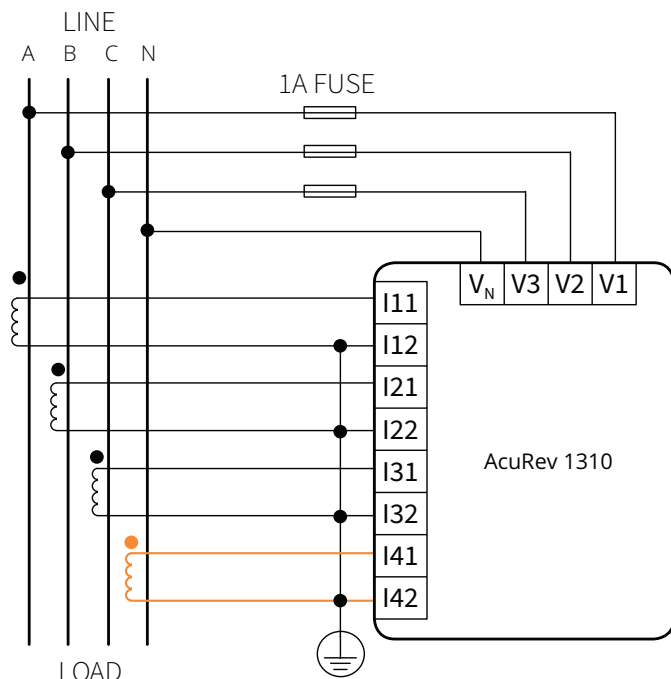

NEMA 4X Rated Wall Mount Enclosure For AcuRev 1310 Series

The AcuRev 1310 enclosure (AcuRev 1310-ENC) offers a mounting option for AcuRev1310 Series energy meters that helps protect from tampering and the elements.



AcuRev 1310 Series Models

	1311	1312	1313	1314
Application	DIN-Rail mounted realtime energy monitoring	DIN-Rail mounted real-time power and energy monitoring	DIN-Rail mounted real-time bi-directional power and energy monitoring	DIN-Rail mounted real-time multifunction monitoring with neutral current measurement and calculated residual current
Metering	Energy, Voltage, Current, Active Power	Energy, Time-of-Use, Power Demand, Current Demand, Voltage, Current, Power, Power Factor, Frequency	Energy, Time-of-Use, Power Demand, Current Demand, Voltage, Current, Power, Power Factor, Frequency	Energy, Time-of-Use, Power Demand, Current Demand, Voltage, Current, Power, Power Factor, Frequency
Current Input	5A/1A: Field-Configurable 5A or 1A Current Transformer Input 333mV: 333mV Current Transformer Input RCT: Flexible Rogowski Coil Current Transformer Input 80/100/200mA: Field Configurable 80mA, 100mA or 200mA Current Transformer Input			
I/O Options	One relay output for alarm and remote control			

EV300



Panel Meter Series

The EV300 energy meter is equipped with key essential metering parameters for an affordable, reliable solution. Combining revenue grade accuracy and custom I/O options, this panel-mountable meter's compact form-factor is ideal for a wide range of applications.

ACCUENERGY.COM/EV300



Key Specifications

- Bi-directional energy metering
- Utility revenue grade accuracy
- Field configurable 5A/1A CT input
- Compatible with both 50Hz and 60Hz systems
- RS485 port built-in with Modbus-RTU
- Standard panel mount 96mm DIN-direct retrofit
- Switch status monitoring and controlling
- Energy pulse output
- 4-20mA analog transducer output
- Over/Under limit alarm-triggered relay output
- Lowest cost in the same class guaranteed

PRODUCT COMPATIBILITY



ACUPANEL
COMPATIBLE
METER



ACUCLOUD

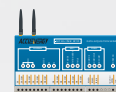

ACULINK 810

Modbus-RTU via RS485

EV300 series meters are Modbus-RTU protocol ready, allowing meter data interoperability between devices that utilizes serial communication.

Frequency

Automatic frequency detection adapts to 50Hz or 60Hz systems without compromising accuracy, simplifying the design and eliminating international OEM frequency issues.

Voltage

Supports any voltage system with a rating between 10V to 230V/400V. It also allows potential transformer ratio configuration.

Digital Output

Pulse output monitors all utilities including water, gas, & electricity provides energy data to any data acquisition server without communication.

Current

Field-configurable 5A and 1A CT input to suit any industrial current transformer.

Analog Output

Industry standard signal 4-20mA analog output is used for automation and process control and can be directly used with any programmable logic controller (PLC).

EV300 Series Models

	EV387	EV390
Voltage (V)	•	•
Current (Amp)	•	•
Power (kW)		•
Reactive Power (kVar)		•
Apparent Power (kVA)		•
Power Factor (PF)		•
Frequency (Hz)		•
Energy (Import/Export/Total/Net)		•
Reactive Energy (Import/Export/Total/Net)	•	•
Modbus-RTU via RS485	•	•
LCD Display	•	•

EV300 Series Input/Output Selection Table

	E0	E1	E2	E3	E4
Digital Input	2	6	6	6	6
Digital Output (Pulse)	-	-	2	2	-
Analogue Output (4-20mA)	-	-	-	2	2
Relay Output	-	2	-	-	2
Auxiliary Power 24Vdc	-	1	1	-	-

AcuPanel 9100



Pre-Wired Metering Panels

Cut down on costly installation & avoid wiring error with these pre-configured and pre-installed panel metering systems. The AcuPanel series also feature some of Accuenergy's most powerful meters including the Acuvim II, Acuvim L, and AcuRev 2100 series, secured in a either a NEMA 4 or NEMA 4X enclosure for versatile installation options.

ACCUENERGY.COM/ACUPANEL



Key Specifications

- Factory pre-wired for fast, reliable installation
- Factory pre-configuration eliminates meter programming on-site
- Required accessory components are all pre-installed
- Self-powered panel does not require separate power supply
- Durable enclosures provide high tolerance for external force with well protection
- Housed in either a NEMA 4 rated industrial steel enclosure, or NEMA 4X rated polycarbonate enclosure for either indoor or outdoor implementation
- Available metering options include the Acuvim II Series, Acuvim II BN, Acuvim L Series, EV300, AcuDC 240, and AcuRev 2100.

PRODUCT COMPATIBILITY



ACUDC240



ACUVIM II



ACUVIM-L



EV300

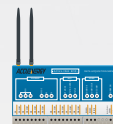

ACULINK 810



ACUREV 2100



Clean Factory Wiring

Factory installed connections and components have been diligently tested to be reliable and dependable for an error-free integration into your system.



Components Included

Pre-assembled shorting blocks for current transformers and fused terminal blocks for voltage connections are colour coded and clearly labeled to allow for time-saving maintenance and identification.

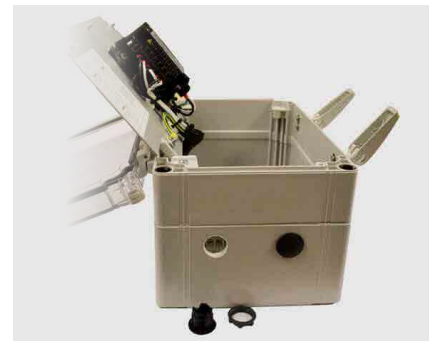

Pre-Cut Enclosure

Two pluggable, pre-cut holes allow wires to be securely fed through the enclosure without any added modifications to the enclosure. Simple grounding wire are firmly installed inside.

NEMA 4 Enclosure

Made from durable steel, this indoor rated enclosure provides a degree of protection against dirt, dust, and other solid objects.

NEMA 4X Enclosure

Rated for indoor and outdoor use, this NEMA 4X enclosure provides the ultimate shield against hostile environmental hazards including adverse weather & corrosion.

Standard pre-wired enclosure includes:

- Terminal blocks for current transformer input
- Shorting block for current transformer
- Terminal blocks for voltage input
- 3 Industrial-grade fuses



AcuPanel Series Models

	AcuPanel 9104	AcuPanel 9104X	AcuPanel 9104X-DC	AcuPanel 9106X
Compatible Meters	Acuvim II, Acuvim IIBN, Acuvim L, EV300	Acuvim II, Acuvim IIBN, Acuvim L, EV300	AcuDC 240	AcuRev 2100
Application	Indoor installations that require rugged protection, but not weather resistance	Indoor or outdoor installations that require exceptional environmental protection and weather resistance		
NEMA Rating	NEMA 4	NEMA 4X	NEMA 4X	NEMA 4X
Material	Steel	Polycarbonate	Polycarbonate	Polycarbonate
Anti-Corrosive		•	•	•
Dust-Proof	•	•	•	•
Suitable for Indoor Use	•	•	•	•
Suitable for Outdoor Use		•	•	•
Pre-Wired	•	•	•	•
Pre-Configured	•	•	•	•



AcuRev 2100

Multi-Circuit Submeter with SnapOn CT Technology

Monitor Multiple Circuits with SnapOn CT Technology. The AcuRev 2100 is the next-generation multi-circuit power and energy meter designed to measure 18 single-phase circuits using SnapOn CT technology for quick and easy installations in high-density, multi-point applications. Reliably monitor real-time energy consumption and power quality in commercial, residential, and industrial multi-tenant energy management systems.



ACCUENERGY.COM/ACUREV-2100



Key Specifications

- 18 single-phase or 6 (or 9) polyphase circuits
- Measurement Canada approved revenue-grade (ANSI C12.2 Class 0.5 & IEC 62053-22 Class 0.5s)
- Advanced power quality analysis
- Built-in WEB2 module meets all communication protocol needs
- Modbus, BACnet, SMTP, HTTP/HTTPS Post, FTP & NTP, SFTP, SNMPv3, and RSTP
- WiFi communication channel, with IPv6
- Remote meter access via `SerialNumber.accuenergy.io`
- Dual Ethernet ports for unparalleled communication and daisy-chain connection
- Secure and encrypted HTTPS web server for meter reading and configuration
- 8GB onboard memory for data logging and historical trend analysis
- Programming and terminal tamper-proof seal
- 18 Digital Inputs for water and gas metering
- 6 Digital Outputs, 2 Relay Outputs
- Optional cloud-based data storage with AcuCloud

PRODUCT COMPATIBILITY

SnapOn CT Technology

Accuenergy has designed an innovative CT technology that allows any 80mA, 100mA, or 333mV current transformer to plug into the AcuRev 2100 submeter without the use of traditional terminal blocks or error prone wiring configuration. Simply attach the SnapOn connector to a CT and plug into the meter for a fast, convenient installation experience. 20 SnapOn CT connectors are included with the meter.

Measurement Canada Approved

The AcuRev 2100 is approved to meet stringent Measurement Canada specifications and ANSI C12.20 Class 0.5 and IEC 62053-22 Class 0.5s accuracy requirements. Terminal sealing provides added security, prevents tampering with metering settings, and safeguards data integrity.

Over/Under Limit Alarms

Ten limit alarms can be assigned to various conditions. The alarm function effectively alerts and protects systems by sending out notifications and automatically shutting down equipment. Alarms can be configured for peak demand, current, or power quality thresholds. Use the web interface to view active and historical alarms, as well as configure new alarms.

WEB2

The built-in WEB2 module provides remote access to real-time energy data monitoring. View details on power & energy, power quality, and other critical measurements. A wide range of communication methods are supported including dual Ethernet & WiFi. Additionally, it provides compatibility with an array of industrial protocols including Modbus TCP/IP, BACnet IP, MQTT, SMTP, HTTP/ HTTPs Post, and more.

Power Quality Analysis

Power quality analysis is essential in industrial & commercial applications where protecting sensitive electronic equipment is critical. AcuRev 2100 series meters provide power quality parameters such as voltage and current THD, individual voltage and current harmonics up to the 31st order, voltage crest factor, current K factor, and voltage and current unbalance. These parameters are monitored in real-time and logged in memory.

Data Logging

Real-time energy metering, power quality analysis, and I/O data can be stored in the onboard, non-volatile memory. Logged information can be retrieved via serial connection or remotely by Ethernet in Excel, CSV, or text format for historical trending and system analysis. The ample internal memory provides class-leading storage capacity suitable for any advanced application. For instance, it will take over 100 years to fill the memory if the meter is configured to monitor 100 energy parameters at 5-minute intervals.

IP66/67 Rated Wall Mount Enclosure

The AcuRev 2100 enclosure (ENC-12127PIP67) offers a mounting option for AcuRev 2100 Series energy meters that helps protect from tampering and the elements.



AcuRev 2100 Series Models

AcuRev 2110	
Application	Multi-Tenant & High-Density Submetering
Number of Single Phase Circuits Monitored	18
Number of Three Phase Circuits Monitored	6
CT Input	80mA, 100mA, 333mV, Rogowski Coil
Communication	RS485, Dual RJ45, WiFi





AcuDC 240



DC Energy Meter

The AcuDC 240 series of DC power and energy meters are designed for monitoring DC consumption and generation in applications like renewable energy. The AcuDC 240 is a effective metering device able to read voltage, current, power, energy and ampere-hour.

ACCUENERGY.COM/ACUDC-240



Key Specifications

- Built-in three-line LCD
- Modbus-RTU communications.
- Monitor and control power switches
- Standard 72x72mm size allows for drawer-type panel installation
- 0.2% accuracy on voltage and current; 0.5% on power and energy parameters.
- Accessible with SCADA, PLC systems
- Onboard datalogging provides historical logging of all DC metering parameters for analysis
- Built-in Hall effect sensor power supply (+/-15Vdc) for ease-of-measuring
- Optional digital input and output, analog and relay output I/O expansions

PRODUCT COMPATIBILITY

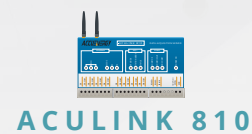

Solar Arrays

Directly monitor the power and energy produced from the solar array, before the inverter, for the most accurate analysis of solar production.

Wind Turbines

Meter the production and effectiveness of wind generated energy before its sent into the grid and integrate with existing systems through Modbus-RTU.

Vehicle Charging

Audit and observe the electrical consumption of charging stations or individual EV motors from a charge station in real time, as an accumulated total, and with historical data logging.

Communications Modules

These plug-in expansion modules are available for the AcuDC line of DC power and energy meters.



AcuDC 240 Series Din Rail Mounting Adapter

AcuDC 240 Series DIN Rail adapter (DC-DIN) provides an easy installation for all panel-mounted AcuDC 240 meter models and I/O options that require a DIN rail solution.

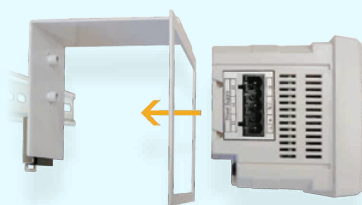

AcuDC 240 Series Models

Function	AcuDC 243
Application	All DC Monitoring & Metering Applications
Metering Parameters	Voltage, Current, Power, Energy, Ampere-Hour
I/O Modules Available	•
Data Logging	Optional
Communication Protocol	Modbus-RTU

AcuDC 240X Expansion Modules

	Digital Input (DI)	Analogue Output (AO)	Analogue Input (AI)	Relay Output (RO)	Digital Output (DO)	Hall Effect Sensor Power Supply
X1	2	2				
X2	2	2				
X3	2			2		
X4	2				2	
X5	2					+/-15Vdc
X6			2			+/-15Vdc
X7			2			+/-15Vdc



AcuCloud



Energy Management Software

AcuCloud Software is a cloud-based energy data management platform that provides facilities professionals access to real-time and historical data from power and energy meters. Users can view, download, and share energy data as well as perform sophisticated analysis and report creation.



ACUENERGY.COM/ACUCLOUD

Key Features

- Feature-rich set of tools for monitoring real time energy, performing M&V, interpreting energy trends, and analysing a complete energy portfolio.
- Efficient delivery of complex data in an intuitive, user-friendly format.
- Seamless integration with Accuenergy web-enabled devices or via AcuLink 810 as a gateway for serial and third party devices.

PRODUCT COMPATIBILITY



Data Storage + History

Energy managers have access to energy data in unparalleled detail. AcuCloud stores the history for important energy parameters including per phase and system voltage, current, power, energy, power factor, demand, and pulse data in 5-minute intervals.

Data Sharing + Integration

Successful energy management depends on the stable integration of energy data across platforms. AcuCloud makes it easy to forward all metered data to a 3rd party software system for analysis, reporting, billing, efficiency studies, or measurement & verification projects. Multiple data formats are supported.

Flexible Reporting

Collaborate with colleagues on critical facility decisions: AcuCloud features a powerful sharing tool which allows data to be downloaded & emailed for insightful project coordination. Easily send all reports or choose from a range of valuable, pre-configured dashboards that highlight key energy management metrics.

Convenient Alerts

When energy usage reaches a threshold or if a meter goes offline, a timely alert can be critical to ongoing facility operations. AcuCloud offers configurable email alerts that are automatically triggered.

Powerful Data Analysis

Metered data has no value without additional analysis from sophisticated software. Simple, yet powerful data analytics tools provide actionable insight. Monitor trends, perform analysis, manage energy projects, and more.



APPLICATIONS:

Tenant Kilowatt-Hour Profiles

- Provide each tenant with account access to view real-time energy & consumption trends
- Tenant profiles raise awareness of energy usage and can be compared against building averages
- Analyze the energy usage for multiple tenant groups

Tenant Billing Management

- Manage tenant bills individually
- Adapt to various billing structures
- Generate bills from multiple submeters for internal rebilling or cost allocation
- Use custom rate structures and formulas to create bills that fit any circumstance

ACUCLOUD INTEGRATION EXTENSIONS:

Tariff Analytics

Quickly assess the anticipated savings when negotiating new energy contracts with utilities. Enter a proposed rate and the tariff analysis tool calculates payments based on the past energy consumption.

Trending Analytics

Energy profiles make it easy to analyze usage patterns and identify irregularities.

Measurement and Verification

An advanced alternative to tedious spreadsheets: track energy conservation, calculate average consumption, and verify outcomes after upgrades.

Dashboard

Use configurable widgets to monitor measurements, metrics, and savings.

AcuLink 810



Data Acquisition Server & Gateway

Accuenergy's AcuLink 810 is a comprehensive DAQ BACnet gateway and server. Devices and metering data can be managed and accessed through a central hub before distributed to an energy management system. Energy data is available to be stored locally or transferred via an IP-based network to a remote server or controller.

ACCUENERGY.COM/ACULINK-810



Key Specifications

- Track energy usage, peak demand and other energy parameters
- BACnet-MS/TP data acquisition and logging with 8GB on-board memory
- BACnet gateway (Converts Modbus-RTU and BACnet-MS/TP to BACnet IP)
- Remote access to monitor and configure devices
- RSTP high availability to reduce network downtime
- Poll data from all RTU devices via Modbus-TCP/IP
- Ethernet Gateway for Modbus RS485 and Digital Output Devices
- Remote web-server access for real-time data and easy configurations
- Dual Ethernet RJ45 port and WiFi communication channels
- SSL and TLS1.2 compliant enhanced cybersecurity protection
- Over/Under alarm monitoring for connected devices

PRODUCT COMPATIBILITY



BACnet Gateway

AcuLink 810 can read Modbus, BACnet, and MBus devices offering integrators the option to retrofit existing systems saving time and costs. Support for multiple protocols facilitates the intercommunication of devices by allowing such devices to interoperate on a BACnet IP network.

Data Logging

Critical data, such as energy and power quality measurements, is stored in 8GB non-volatile memory with a capacity for over three years of energy data collected at 15-minute intervals. Logged information is easily retrieved from a web browser or posted to a remote sever via HTTP/HTTPs, FTP in CSV or JSON format.

Embedded Web Server

Access and monitor all connected devices anytime, anywhere using a web browser. A friendly UI allows users to easily view of all collected devices with detailed real-time metering summary, setup, alarms, and configurable upload channels.

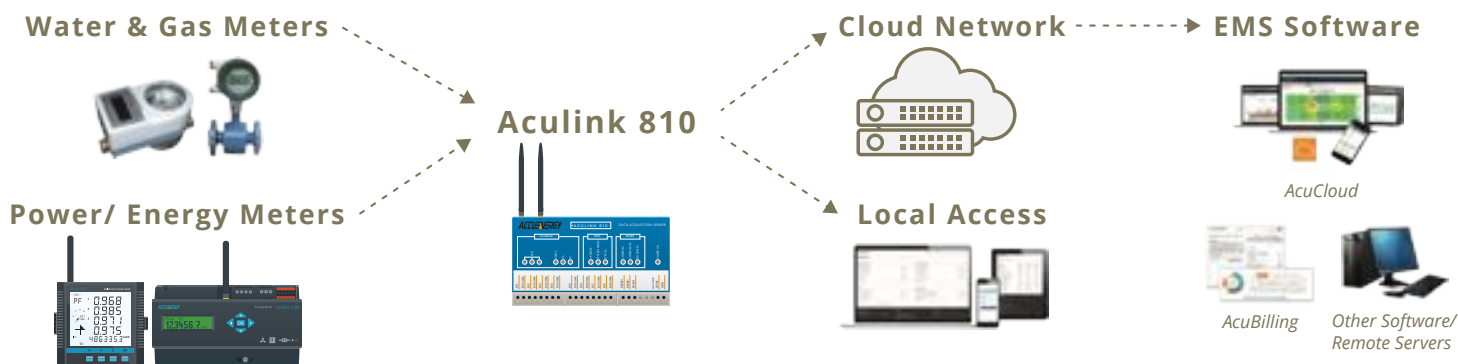

IoT Connectivity

Support for MQTT protocol allows subscribers to instantly receive up-to-date device data to their mobile phone or other Internet of Things devices. Messages can be configured to send at intervals for specific connected devices.

Poll Downstream Data

Allow a Modbus master on a remote network to poll downstream metering data directly from all RTU devices that are connected to the DAQ BACnet gateway. The AcuLink 810 supports Modbus polling for eight pulse counters used for water, heat, gas and electricity metering.

Daisy Chain 32 Devices

Users can daisy-chain up to 32 devices using the RSTP protocol. This can cut down the amount of network switches required in different applications and allows the use of 1 network switch/router to be used with up to 32 devices. An additional 32 Modbus-RTU devices can be connected via USB port.

AcuLink 810 Gateway Conversion

	AcuLink 810-X	AcuLink 810-900	AcuLink 810-868
Gateway	Incoming Protocols	Modbus-RTU, Modbus-TCP/IP, BACnet-MS/TP, BACnet-IP, SunSpec, Mbus, Pulse Counter, Virtual Meter	
	Outgoing Protocols	Modbus-TCP/IP, BACnet-IP, SNMP, HTTP, HTTPs, FTP, sFTP, MQTT	
Digital Input		8 Pulse Counters	
Onboard Memory		8GB	
Interval Logging		1 to 1,440 Minutes	
AcuMesh 900Mz		●	
AcuMesh 868Mz		●	

AcuMesh



Wireless RS485 Transceiver

The AcuMesh network solution is designed to connect RS485-enabled devices including meters, sensors, gateways, PLCs, and more into a seamless wireless network. It offers a cost-effective, non-intrusive installation that eliminates the need for additional communications wiring.

ACCUENERGY.COM/ACUMESH

ROHS
COMPLIANT



Key Specifications

- Devices are connected automatically on power up without configuration or software
- Compatible with Modbus-RTU protocol
- Utilizes either the 900MHz or 868MHz frequency band available in most countries.
- Highly secure communication with 128-bit Advanced Encryption Standard (AES)
- Field-upgradable firmware
- Complex networks are easily configured using free software
- Communicate wirelessly between meters and other RS485 devices running any protocol within a building or campus
- Long-range communication: 1000 ft (305m) indoor / 4 Miles (6.5km) outdoor in a single hop

AcuMesh Wireless RS485 Network

The AcuMesh wireless RS485 network solution eliminates the need for physical RS485 communication wiring. Devices directly connect to an AcuMesh transceiver and the job is done. The AcuMesh transceiver transmits data and commands wirelessly within the network.



AcuCT Flex

Rogowski Coils

Designed for unmatched ease-of-installation, this specialized line of flexible AC current transformers is ideal for deployment in power metering, power quality, and general use applications where space is limited.

ACCUENERGY.COM/ACUCT-FLEX



Key Specifications

- High accuracy for demanding applications
- Wide current input range 5A - 50,000A AC
- Four coil lengths available: 16", 24", 36", or 47"
- A broad frequency range makes it an excellent choice for monitoring harmonics and power quality
- Directly compatible with Accuenergy RCT input devices - no external power supply or integrator needed

4 Standard Lengths

We offer four coil lengths: 16", 24", 36", and 47". Custom lengths available upon request.

Flexible Style CT

Rope-like coil allows it to fit into limited spaces where regular, ridged CTs cannot be used.

Wide Current Sensing

Measure current from 5A to 50,000A on a standard coil.
Higher current range available upon request.

Wide Frequency Response Range

Standard frequency response range 10 Hz - 20kHz.
Higher frequency range available upon request.

High Accuracy & Linearity

Accuracy is 0.5% across the entire range of measurement.

Standard & Custom Output

Multiple output ratio options available, including: 100mV/1000A, 40mV/1000A, 25mV/1000A, 10mV/1000A.

AcuCT Flex Series Options

	RCT16	RCT24	RCT36	RCT47
Input Range	5A - 50000A	5A - 50000A	5A - 50000A	5A - 50000A
Output Option	Output to Specified RCT input			
Window Size	4.17" (106mm)	7.01" (178mm)	10.67" (271mm)	14.53" (369mm)
Length	15.75" (400mm)	23.62" (600mm)	35.43" (900mm)	47.24" (1200mm)
Accuracy	0.5% Combined with Acuvim II Series at Any Point			



RIK Series

Rogowski Integrator

The integrators are a versatile, plug-and-play solution that allows Rogowski coils to be field-configurable for multiple CT input ratios. Single-phase and three-phase options are available.

ACCUENERGY.COM/ACUCT-RIK



Key Specifications

- CT ratios are field-configurable for on-site flexibility.
- Output types include 0-5A, 0-1A, 0-333mV, 4-20mA, 0-20mA, 0-5V, 0-10V
- RIK 1AR: 0-A Output Relay Class (5P20).
- Individual CT ratios can be configured for each channel.
- Works in any single-phase or three-phase applications.
- Works in both 50Hz and 60Hz systems.
- Four coil lengths available (sold separately).

RIK Series Options

	RIK 1AR*	RIK 5A	RIK mV*	RIK mA*	RIK V*
Current Measurement Range	0.25A - 100kA		2.5A - 60,000A		
Sensing Range	50A, 200A, 500A, 2000A and 5000A (User Selectable)	500A, 1000A, 2500A, 5000A, 10000A, 25000A and 50000A (Field Configurable)			
Output Rated Options	0-1A	0 – 6A RMS (0 – 5A RMS Nominal)	0-333mVac	4-20mA _d c, 0-20mA _d c	0-5V _d c, 0-10V _d c
Accuracy	% at 1A, 5% at 20A	1.0%	1.0%	1.0%	1.0%
Rogowski Coil Sizes			16", 24", 36", 47"		
Frequency	50Hz and 60Hz		45Hz to 65Hz		
Single-Phase	•	•	•	•	•
Three-Phase		•	•	•	•

*Rogowski coil and power supply sold separately.



AcuCT R



Revenue-Grade Split-Core CT

High-accuracy split core current transformers with a unique press-to-open hinged design and current input range from 5A to 5000A AC. AcuCT R also offers revenue grade accuracy for billing applications.

ACCUENERGY.COM/ACUCT-R

AcuCT R Series Options

	AcuCT-075R	AcuCT-100R	AcuCT-125R	AcuCT-200R	AcuCT-3135R	AcuCT-4161R	AcuCT-5170R
Input Range	1A - 150A	5A - 250A	5A - 400A	5A - 1000A	5A - 1000A	5A - 5000A	5A - 5000A
Typical Input	50A, 100A, 150A	100A, 200A, 250A	100A, 200A, 300A, 400A	400A, 600A, 800A, 1000A	600A, 800A, 1000A, 1200A, 1500A	1200A, 1600A, 2000A, 2500A, 3000A, 4000A, 5000A	2000A, 3000A, 4000A, 5000A
Output Option	333mV, 80mA, 100mA, 200mA	1A, 333mV, 80mA, 100mA, 200mA	1A, 333mV, 80mA, 100mA, 200mA	1A, 333mV, 80mA, 100mA, 200mA	5A, 1A, 333mV, 80mA, 100mA, 200mA	5A, 1A, 333mV, 80mA, 100mA, 200mA	5A, 1A, 333mV, 80mA, 100mA, 200mA
Window Size	0.75" x 0.75" (19.5 x 19.5 mm)	1" x 1" (25 x 25 mm)	1.25" x 1.25" (32 x 32 mm)	2" x 2" (51 x 51 mm)	3.1" x 3.5" (80 x 90 mm)	4.1" x 6.1" (105 x 155 mm)	5.1" x 7" (130 x 180 mm)
Exterior Dimensions	2.3" x 2.3" x 0.9" (58 x 58 x 22 mm)	2.6" x 2.6" x 0.9" (65 x 65 x 22 mm)	3.2" x 3.2" x 0.9" (82 x 82 x 22 mm)	4.4" x 4.4" x 1.25" (111 x 111 x 32 mm)	5.7" x 6.1" x 1.25" (144 x 154 x 32 mm)	7.3" x 9.3" x 1.8" (185 x 235 x 45 mm)	8.3" x 10.2" x 1.8" (210 x 260 x 45 mm)
Accuracy	IEC 60044-1 0.5s class						

AcuCT mV



333mV Split-Core CT

Split-core CT with 333mV output is designed for retrofit projects used in general panel metering applications. It can be pulled apart and securely pushed back together to allow installation without disrupting the existing system.

ACCUENERGY.COM/ACUCT-MV



AcuCT mV Series Options

	AcuCT-075	AcuCT-125	AcuCT-200	AcuCT-3050
Input Range	10A - 200A	30A - 600A	60A - 1500A	40A - 5000A
Typical Input	100A, 200A	300A, 400A, 600A	600A, 800A, 1000A, 1200A, 1500A	400A, 600A, 1000A, 1500A, 2000A, 3000A, 5000A
Rated Option	333mV			
Window Size	0.75" x 0.75" (19.1 x 19.1 mm)	1.25" x 1.25" (31.8 x 31.8 mm)	2" x 2" (50.8 x 50.8 mm)	3" x 5" (76.2 x 127 mm)
Exterior Dimensions	2" x 2.098" x 0.669" (50.8 x 53.3 x 17 mm)	3.248" x 3.35" x 1.025" (82.5 x 85.1 x 26 mm)	4.764" x 5" x 1.81" (121 x 127 x 30 mm)	5.748" x 7.5" x 1.402" (146 x 190.5 x 35.6 mm)
Accuracy	0.5%	0.5%	0.5%	0.5%



AcuCT 5A



5A Split-Core CT

Split-core CT with 5A output is ideal for a wide range of industrial metering solutions where accuracy is critical. Designed with specialized mounting clips and tension screws for optimal installation.

ACCUENERGY.COM/ACUCT-5A

AcuCT 5A Series Options

	AcuCT-0812	AcuCT-2031	AcuCT-3147	AcuCT-3163
Input Range	5A - 400A	5A - 1000A	5A - 1600A	5A - 5000A
Typical Input	100A, 150A, 200A, 250A, 300A, 400A	400A, 600A, 800A, 1000A	1000A, 1200A, 1600A	2000A, 2500A, 3000A, 4000A, 5000A
Output Option	5A, 1A	5A, 1A	5A, 1A	5A, 1A
Window Size	0.83" x 1.22" (21 x 31 mm)	1.97" x 3.15" (50 x 80 mm)	3.15" x 4.72" (80 x 120 mm)	3.15" x 6.3" (80 x 160 mm)
Exterior Dimensions	3.5" x 4.13" x 1.57" (89 x 105 x 40 mm)	3.5" x 4.13" x 1.57" (89 x 105 x 40 mm)	5.67" x 7.28" x 1.97" (144 x 185 x 50 mm)	6.93" x 9.72" x 2.76" (176 x 247 x 70 mm)
Accuracy	0.5%	0.5%	0.5%	0.5%



AcuCT Hinged



Compact Split-Core CT

Ultra small hinged split-core CT can be used on branch circuits within an electrical panel with spatial constraints. Simple to install and quick to deploy in retrofit applications with a 333mV rated output.

ACCUENERGY.COM/ACUCT-HINGED

AcuCT mV Series Options

	AcuCT-H040	AcuCT-H063	AcuCT-H100	AcuCT-H138
Input Range	5A - 75A	5A - 150A	5A - 250A	10A - 630A
Typical Input	20A, 30A, 40A, 50A, 60A	50A, 100A, 150A	100A, 120A, 200A, 250A	200A, 400A, 600A
Rated Option	333mV			
Window Size	0.4" (10.2 mm)	0.63" (16 mm)	1" (25.4 mm)	1.38" (35 mm)
Exterior Dimensions	1.16" x 1.64" x 1.04" (29.4 x 41.7 x 26.4 mm)	1.42" x 2.09" x 1.2" (36 x 53 x 30.5 mm)	2" x 2.76" x 1.52" (50.8 x 70.1 x 38.6 mm)	2.56" x 3.27" x 1.57" (65 x 83 x 40 mm)
Accuracy	0.5%			



AcuCT S113



Solid-Core Current Transformer

Accuenergy solid core CTs are compact, cost-efficient, and provide high accuracy measurements in a rugged form factor. Designed specifically for integration into products that require accurate 1% signal transformation, the solid core design makes them especially resilient in harsh, industrial environments.

ACCUENERGY.COM/ACUCT-S113

AcuCT S113 Solid-Core Series Options

	AcuCT S113-200	AcuCT S113-300	AcuCT S113-400
Primary Input	200A	300A	400A
Rated Output	1A, 5A, 333mV	1A, 5A, 333mV	1A, 5A, 333mV
Rated Voltage	<1,000V	<1,000V	<1,000V
Burden	≤3.75VA	≤3.75VA	≤3.75VA
Rated Frequency	50Hz - 60Hz	50Hz - 60Hz	50Hz - 60Hz
Exterior Dimension	2.38" x 2.68" x 0.96" (60.5 x 68.0 x 24.5 mm)	2.38" x 2.68" x 0.96" (60.5 x 68.0 x 24.5 mm)	2.38" x 2.68" x 0.96" (60.5 x 68.0 x 24.5 mm)

AcuCT S77



Revenue-Grade Solid-Core CT

Solid-core CT feature a class-leading 0.15% accuracy while exceeding Measurement Canada requirements for use in metering installations. Its compact size can be used for applications that requires high precision signal transformation.

ACCUENERGY.COM/ACUCT-S77



AcuCT S77 Series Options

	AcuCT S77-100	AcuCT S77-200
Primary Input	100A	200A
Rated Output	80mA, 100mA	80mA, 100mA
Resistance	50 MΩ	50 MΩ
Burden	0.005	0.005
Window Radius	0.78" (19.7 mm)	0.78" (19.7 mm)
Exterior Radius (in)	2.01	2.01

AcuCT S220



NEW PRODUCT

Switchgear Solid-Core Current Transformer

High precision solid-core current transformer for permanent installations. The AcuCT S220 features multiple input and output options in a small compact form factor. It provides consistent, reliable measurements across industrial and commercial for general metering or switchgear applications.

ACCUENERGY.COM/ACUCT-S220



AcuCT S220 Series Options

	AcuCT S220
Primary Input	300A, 500A, 600A, 800A, 1000A, 1200A, 1500A
Rated Output	5A, 1A, 333mV
Insulation Resistance	500V/100MΩ min
Burden	2.5-5VA
Exterior Dimension	115.0mm x 125.0mm x 32.0mm (4.53" x 4.92" x 1.26")
Window Size	Ø 57.0mm (2.24")

AcuCT S335



NEW PRODUCT

Busbar Solid-Core Current Transformer

Ideal for mounting to a busbar or a cable, the AcuCT S335 is a solid-core current transformer for permanent installations. Features multiple input and output options in a compact form factor. It provides consistent, reliable measurements across industrial and commercial for general metering applications.

ACCUENERGY.COM/ACUCT-S335



AcuCT S335 Series Options

	AcuCT S335
Primary Input	500A, 600A, 800A, 1000A, 1200A, 1500A, 2000A, 2500A, 3000A
Rated Output	5A, 1A, 333mV
Insulation Resistance	500V/100MΩ min
Burden	2.5-5VA
Exterior Dimension	146.0mm x 156.0mm x 32.0mm (5.75" x 6.14" x 1.26")
Window Size	Ø 72.0mm (2.83")





AcuCT S433



NEW PRODUCT

Instrument Solid-Core Current Transformer

The AcuCT 433 is used in permanent metering installations with rated outputs for 5A, 1A, or 333mV. Accuracy rating at 0.5%, it provides consistent, reliable measurements across industrial and commercial for general metering applications.

ACCUENERGY.COM/ACUCT-S433



AcuCT S433 Series Options

	AcuCT S433
Primary Input	800A, 1000A, 1500, 2000A, 2500A, 3000A, 3500A, 4000A
Rated Output	5A, 1A, 333mV
Insulation Resistance	500V/100MΩ min
Burden	2.5-5VA
Exterior Dimension	115.0mm x 125.0mm x 32.0mm (4.53" x 4.92" x 1.26")
Window Size	Ø 93.0mm (3.66")



AcuCT S650

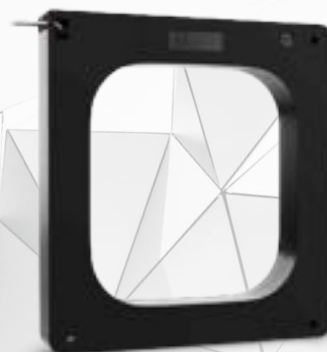

NEW PRODUCT

Solid-Core Current Transformer

High accuracy solid-core current transformer for permanent installations. The AcuCT S650 features multiple input and output options in a small compact form factor. It provides consistent, reliable measurements across industrial and commercial for general metering applications.

ACCUENERGY.COM/ACUCT-S650



AcuCT S650 Series Options

	AcuCT S650
Primary Input	800A, 1000A, 1500A, 2000A, 2500A, 3000A, 3500A, 4000A
Rated Output	5A, 1A, 333mV
Insulation Resistance	500V/100MΩ min
Burden	2.5-5VA
Exterior Dimension	220.0mm x 230.0mm x 35.0mm (8.66" x 9.06" x 1.38")
Window Size	160.0mm x 160.0mm (6.30" x 6.30")



HAB 16555



DC Current Sensors

Ideal for retrofit installation, the split-core, nonintrusive design offers seamless integration into any existing DC electrical system using a bus bar or other large conductor. Available in both unidirectional and bidirectional options, measure up to 5000A with a rated output signal of either 4-20mA or 0-5V.

ACCUENERGY.COM/HAB



DC Current Sensor Series Options

	HAB-16555
Primary Input	1000A, 2000A, 3000A, 4000A, 5000A
Rated Output	4-20mA, 0-5V
Window Diameter Size (in)	6.50 x 2.17
Window Size (mm)	165 x 55
Exterior Dimension	3.80" x 9.25" x 1.93" (96 x 235 x 49 mm)
Accuracy	0.5%
Bidirectional	Optional

HAK



Hall Effect Current Sensors

The HAK Hall Effect current sensor measures DC current up to 1000A with a rated output signal at either 4-20mA or 0-5V. Ideal for sensitive environments, the Hall Effect provides a natural, protective field that isolates the sensor from high electrical fluctuation from the conductor.

ACCUENERGY.COM/HAK



Hall Effect Current Series Options

	HAK21	HAK40
Primary Input	50A, 100A, 200A	400A, 600A, 1000A
Rated Output	4-20mA, 0-5V	4-20mA, 0-5V
Window Diameter Size (in)	0.83	1.58
Window Size (mm)	21	40
Exterior Dimension	2.36" x 2.40" x 0.63" (60 x 61 x 16 mm)	3.94" x 3.94" x 0.94" (100 x 100 x 24 mm)
Accuracy	0.5%	
Bidirectional	Optional	

HV2



HV2 Series

The HV2 Hall effect DC voltage sensor series is designed to provide reliable, accurate voltage measurements in DC applications up to 1500V. Ideal for railway, DC coupled energy storage, solar systems, or other high voltage DC installations.



ACCUENERGY.COM/HV2

HV2 Series Options

	HV2-1000	HV2-1200	HV2-1500
Primary Input	1000V	1200V	1500V
Rated Output	0-5Vdc	0-5Vdc	0-5Vdc
Exterior Dimension	6.57" x 2.44" x 3.58" (167.0 x 62.0 x 91.0mm)		
Accuracy	0.50%	0.50%	0.50%
Polarity	Terminal Connection	Terminal Connection	Terminal Connection

DC Shunts



Shunt Series

DC current shunts are engineered for precision measurement in DC current systems. Pair with a DC power meter in renewable energy, mass transit, battery charging, heavy industrial environments, and other DC current applications.



ACCUENERGY.COM/DC-SHUNTS

DC Current Shunt Series Options

Shunt	50A	100A	200A	500A	1000A	2000A	4000A
Voltage Drop	75mV	75mV	75mV	75mV	75mV	75mV	75mV
Primary Input	50A	100A	200A	500A	1000A	2000A	4000A
Operation Temperature	-40 to +60C	-40 to +60C	-40 to +60C	-40 to +60C	-40 to +60C	-40 to +60C	-40 to +60C
Exterior Dimension	0.98" x 4.72" x 0.87" 25 x 120 x 22mm	0.91" x 4.29" x 0.43" 23 x 109 x 11mm	0.87" x 4.65" x 0.87" 22 x 118 x 22mm	1.81" x 5" x 0.87" 46 x 127 x 22mm	3.82" x 5" x 0.87" 97 x 127 x 22mm	5.35" x 7.87" x 3.82" 136 x 200 x 97mm	7.87" x 7.48" x 3.82" 200 x 190 x 97mm
Accuracy	0.5%	0.5%	0.5%	0.5%	0.5%	0.5%	0.5%





AcuCT C

Current Transformer Converter

AcuCT-C Series access-type precision 5A current transformer is approved by Measurement Canada for rated systems higher than 400A and 800A. Designed with a closed magnetic core, the CT's main benefit is derived from its ultra-micro crystal magnetic core and an advanced secondary winding process to provide stable performance and high accuracy 0.15 measurement.

NEW PRODUCT ACCUENERGY.COM/ACUCT-C



Key Specifications

- Measurement Canada Approved
- IEEE Std C57.13-2016 0.15 class accuracy
- 500V/100MΩ min insulation resistance
- 3,000Vac withstand voltage
- Phase error < 8'
- Ratio error < 0.5%
- Frequency: 50-60Hz

AcuCT C Series Options

	AcuCT C
Input Rating	5A
Rated Output	80mA, 100mA
Phase Error	< 8'
Accuracy	0.15
Exterior Dimension	2.11" x 3.10" x 1.20" (53.5mm x 78.5mm x 30.5mm)

NEED HELP?

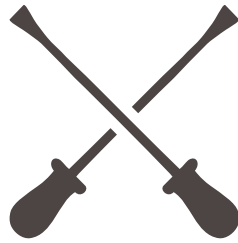

CONTACT US FOR

ENGINEERING

DESIGN & SPECIFICATION SUPPORT



ISO9001 Certified



ACCUENERGY (CANADA) INC.

22 Howden Road
Toronto, ON M1R 3E4, Canada

TF: 1-877-721-8908
INT: +1-416-497-4100
FAX: +1-416-497-4130
E: marketing@accuenergy.com



ACCUENERGY SOUTH AFRICA (PTY) LTD.

Castle Walk Corporate Park, Block B, Cnr.
Nossob & Swakop Street, Erasmuskloof,
Pretoria, 0181, South Africa

TF: +27 (0) 87 802 6136

All specifications are subject to change without notice.

