

# **BFM036/136**

## **Branch Feeder Monitor**

### Installation and Operation Manual

---



## LIMITED WARRANTY

The manufacturer offers the customer a 24-month functional warranty on the instrument for faulty workmanship or parts from date of dispatch from the distributor. In all cases, this warranty is valid for 36 months from the date of production. This warranty is on a return to factory basis.

The manufacturer does not accept liability for any damage caused by instrument malfunction. The manufacturer accepts no responsibility for the suitability of the instrument to the application for which it was purchased.

Failure to install, set up or operate the instrument according to the instructions herein will void the warranty.

Only a duly authorized representative of the manufacturer may open your instrument. The unit should only be opened in a fully anti-static environment. Failure to do so may damage the electronic components and will void the warranty.

The greatest care has been taken to manufacture and calibrate your instrument. However, these instructions do not cover all possible contingencies that may arise during installation, operation or maintenance, and all details and variations of this equipment are not covered by these instructions.

For additional information regarding installation, operation or maintenance of this instrument, contact the manufacturer or your local representative or distributor.

## WARNING

Read the instructions in this manual before performing installation, and take note of the following precautions:

- ⊕ BFM036/136 is intended for measurements performed in building installations, relating to measurement category III (UL61010-1, 6.7.4).
- ⊕ Ensure that all incoming AC power and other power sources are turned OFF before performing any work on the instrument. Failure to do so may result in serious or even fatal injury and/or equipment damage.
- ⊕ Before connecting the instrument to the power source, check the labels on the back of the instrument to ensure that your instrument is equipped with the appropriate power supply voltage, input voltages and currents.
- ⊕ Under no circumstances should the instrument be connected to a power source if it is damaged.
- ⊕ To prevent potential fire or shock hazard, do not expose the instrument to rain or moisture.
- ⊕ The secondary of an external current transformer must never be allowed to be open circuit when the primary is energized. An open circuit can cause high voltages, possibly resulting in equipment damage, fire and even serious or fatal injury. Ensure that the current transformer wiring is secured using an external strain relief to reduce mechanical strain on the screw terminals, if necessary.
- ⊕ Only qualified personnel familiar with the instrument and its associated electrical equipment must perform setup procedures.
- ⊕ Do not open the instrument under any circumstances when it is connected to a power source.
- ⊕ Do not use the instrument for primary protection functions where failure of the device can cause fire, injury or death. The instrument can only be used for secondary protection if needed.

**Read this manual thoroughly before connecting the device to the current carrying circuits. During operation of the device, hazardous voltages are present on input terminals. Failure to observe precautions can result in serious or even fatal injury or damage to equipment.**

All trademarks are property of their respective owners.

September 2007

Copyright 2005-2007 © SATEC Ltd.

# Table of Contents

<b>Chapter 1 General Information.....</b>	<b>7</b>
<b>Labeling .....</b>	<b>8</b>
<b>Chapter 2 Installation.....</b>	<b>9</b>
<b>Mechanical Installation .....</b>	<b>9</b>
<b>Electrical Installation.....</b>	<b>13</b>
<b>Communications.....</b>	<b>18</b>
RS-485 Connection.....	18
RS232 Connection.....	20
Modem Connection .....	20
Ethernet Connection.....	21
RF ZigBee.....	21
<b>Controls and Indicators .....</b>	<b>22</b>
Indicator LEDs .....	22
Energy Pulse LED.....	22
Front Panel Display .....	22
<b>Device Settings .....</b>	<b>23</b>
Password.....	23
Submeter System.....	23
Submeter Addressing .....	23
Basic Device Settings.....	24
Energy/TOU System .....	24
<b>Device Diagnostics.....</b>	<b>24</b>
<b>Chapter 3 BFM136 Display Operations .....</b>	<b>25</b>
<b>Startup Diagnostics.....</b>	<b>25</b>
<b>Display Features .....</b>	<b>25</b>
Submeter Displays .....	25
Display Update.....	25
Auto Return .....	25
Auto Scroll.....	25
Backlight .....	25
<b>Navigation Buttons.....</b>	<b>25</b>
<b>Display Views.....</b>	<b>26</b>
<b>Navigating in Menus.....</b>	<b>30</b>
Entering Numbers .....	30
Entering a Password.....	30
Selecting Menus.....	30
Viewing and Changing Setup Items .....	31
<b>Menu Operations .....</b>	<b>31</b>
Submeter Channel Assignments .....	31
Reset.....	32
Real Time Clock Setting .....	33
Basic Device Settings.....	33
Device Options.....	33
Communication Ports .....	34
Local Network Settings .....	35
Local Settings .....	35
Meter Security.....	35
Display Settings .....	36
<b>Chapter 4 PAS Application Software.....</b>	<b>37</b>

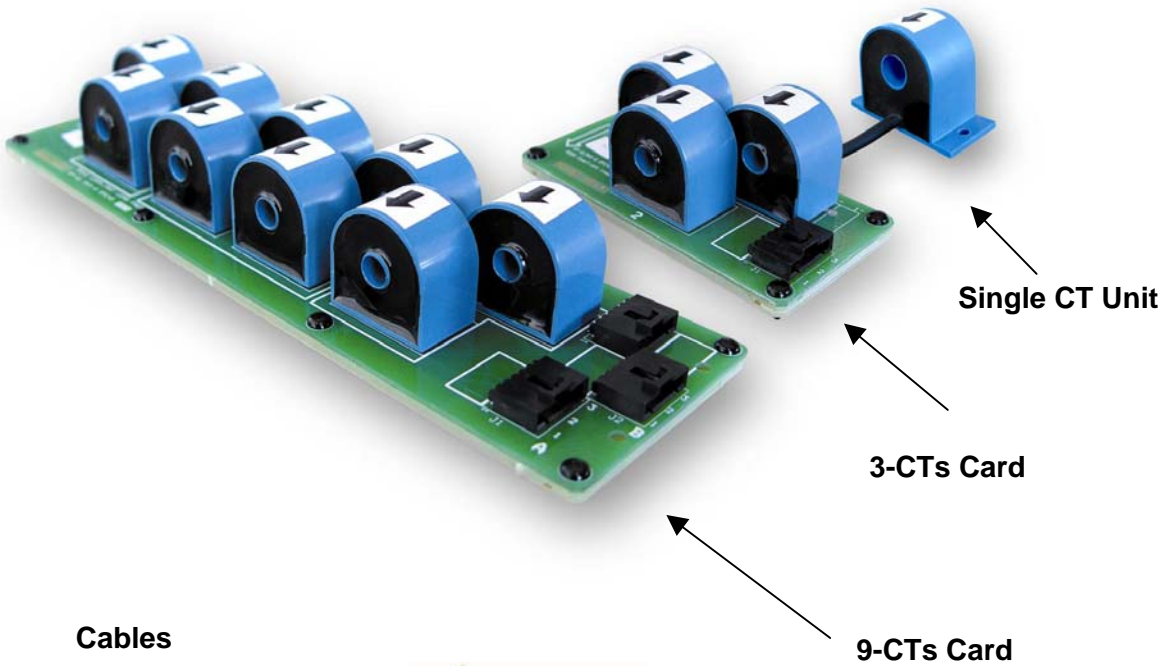
<b>Setting up your Submeters.....</b>	<b>37</b>
<b>Setting up Communications.....</b>	<b>38</b>
Communicating through a Serial Port .....	38
Communicating through the Internet.....	39
<b>Preparing Setups.....</b>	<b>40</b>
Downloading Setups.....	40
Uploading Setups .....	40
<b>Authorization.....</b>	<b>40</b>
<b>Changing Port Settings.....</b>	<b>40</b>
Setting Up Communication Ports .....	41
Setting Up the Local Network.....	41
Configuring Wireless RF Connections.....	42
Configuring eXpertPower Client.....	43
<b>General Meter Setup.....</b>	<b>45</b>
Basic Meter Setup .....	45
Channel Assignments .....	46
Local Settings .....	47
Using Alarm/Control Setpoints.....	48
<b>Configuring Billing Energy and TOU Registers .....</b>	<b>50</b>
Setting up Total and Tariff Registers .....	51
Configuring the Daily Tariff Schedule.....	52
Configuring the Season Tariff Schedule .....	53
<b>Configuring Data Recorders.....</b>	<b>54</b>
<b>Remote Device Control .....</b>	<b>54</b>
Viewing and Clearing Device Diagnostics .....	55
Updating the Clock.....	55
Clearing Maximum Demands and Log Files .....	55
<b>Administration .....</b>	<b>56</b>
<b>Upgrading Device Firmware .....</b>	<b>56</b>
<b>Data Monitoring .....</b>	<b>59</b>
Viewing Real-Time Data .....	59
Retrieving Log Files .....	59
<b>Appendix A Technical Specifications.....</b>	<b>62</b>
<b>Appendix B CT Connection Template .....</b>	<b>65</b>
<b>Appendix C Parameters for Data Monitoring and Logging .....</b>	<b>66</b>
<b>Appendix D Setpoint Triggers and Actions .....</b>	<b>69</b>
<b>Appendix E Data Scales .....</b>	<b>70</b>
<b>Appendix F Device Diagnostic Codes .....</b>	<b>71</b>

**This package contains**

**BFM036/136**



**Current transformer units according to your request**



## Designator Label Sets

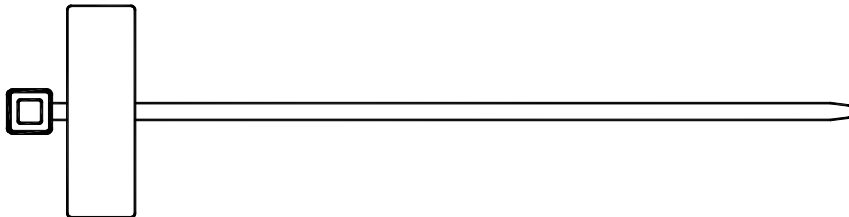
CT card designator label set - to attach to the CT card next to the connector(s)

3	2	1
3	2	1
3	3	1
3	2	1
3	4	1
3	2	1
3	5	1
3	2	1
3	6	1
3	2	1
3	7	1
3	8	1
3	2	1
3	9	1
3	2	1
3	10	1
3	2	1
3	11	1
3	2	1
3	12	1
3	2	1

CT designator label set - to attach to the CT

I1	I10	I19	I28
I2	I11	I20	I29
I3	I12	I21	I30
I4	I13	I22	I31
I5	I14	I23	I32
I6	I15	I24	I33
I7	I16	I25	I34
I8	I17	I26	I35
I9	I18	I27	I36

Cable designator tie-marker



# Chapter 1 General Information

The BFM036/136 is a 3-phase, multi-channel, multi-function energy meter suitable for use in single-phase and multi-phase electrical networks.

The BFM036/136 product line includes two models:

- BFM136 - a device with an LCD display
- BFM036 - a device without an LCD display

## Meter highlights

- Multi-channel submetering - up to 36 single-phase, or 18 two-phase, or 12 three-phase submeters in a single device. Any combination of single-, two-, and three-phase consumers can be chosen up to a total of 36 current inputs.
- Automatic totalization energy from different sub-consumers

## Features

- Class 1 active energy and Class 1 reactive energy meter
- 3-phase/2-phase/single-phase meters (true RMS, volts, amps, power, power factor, neutral current)
- Ampere/Volt demand meter
- Time-of-Use, 4 energy/demand registers x 4 tariffs, 4 seasons x 4 types of days, 8 tariff changes per day, easy programmable tariff schedule
- Automatic 120-day daily profile for energy and maximum demand readings (total and tariff registers) separate for each submeter
- Event recorder for logging internal diagnostic events and setpoint operations
- Data recorders; programmable periodical data logs separate for each submeter
- Embedded programmable controller (4 control setpoints, programmable thresholds and delays) separate for each submeter
- Easy to read 2-row x 16 characters LCD display with backlight (BFM136 only)
- 50/60 Hz operation
- Internal clock, keeping the clock running over one week without external power
- Standard RS-485 serial port
- Optional second communication port. Communication options available:
  - RS-232
  - RS-422/485
  - 56K Dial-up modem
  - Ethernet 10/100BaseT
  - Wireless RF modem (ZigBee, unlicensed 907-922 MHz or 2.4GHz)

- Modbus RTU and Modbus ASCII communication protocols
- Easy field upgrading device firmware through any communication port

## Labeling

MEASUREMENT VOLTAGES :	
(115) 88-138VAC <input type="checkbox"/>	(230) 176-265VAC <input type="checkbox"/>
(277) 176-320VAC <input type="checkbox"/>	
50 Hz <input type="checkbox"/>	60 Hz <input type="checkbox"/>
10VA	
COM2 :	RS-232 <input type="checkbox"/>
	RS-485 <input type="checkbox"/>
	RF <input type="checkbox"/>
	MODEM <input type="checkbox"/>
	ETHERNET <input type="checkbox"/>
	<input type="checkbox"/>
S/N	USE ONLY WITH THE SUPPLIED CURRENT TRANSFORMERS !

05-11018

**Figure 1-1 Device label**



# Chapter 2 Installation

## Mechanical Installation

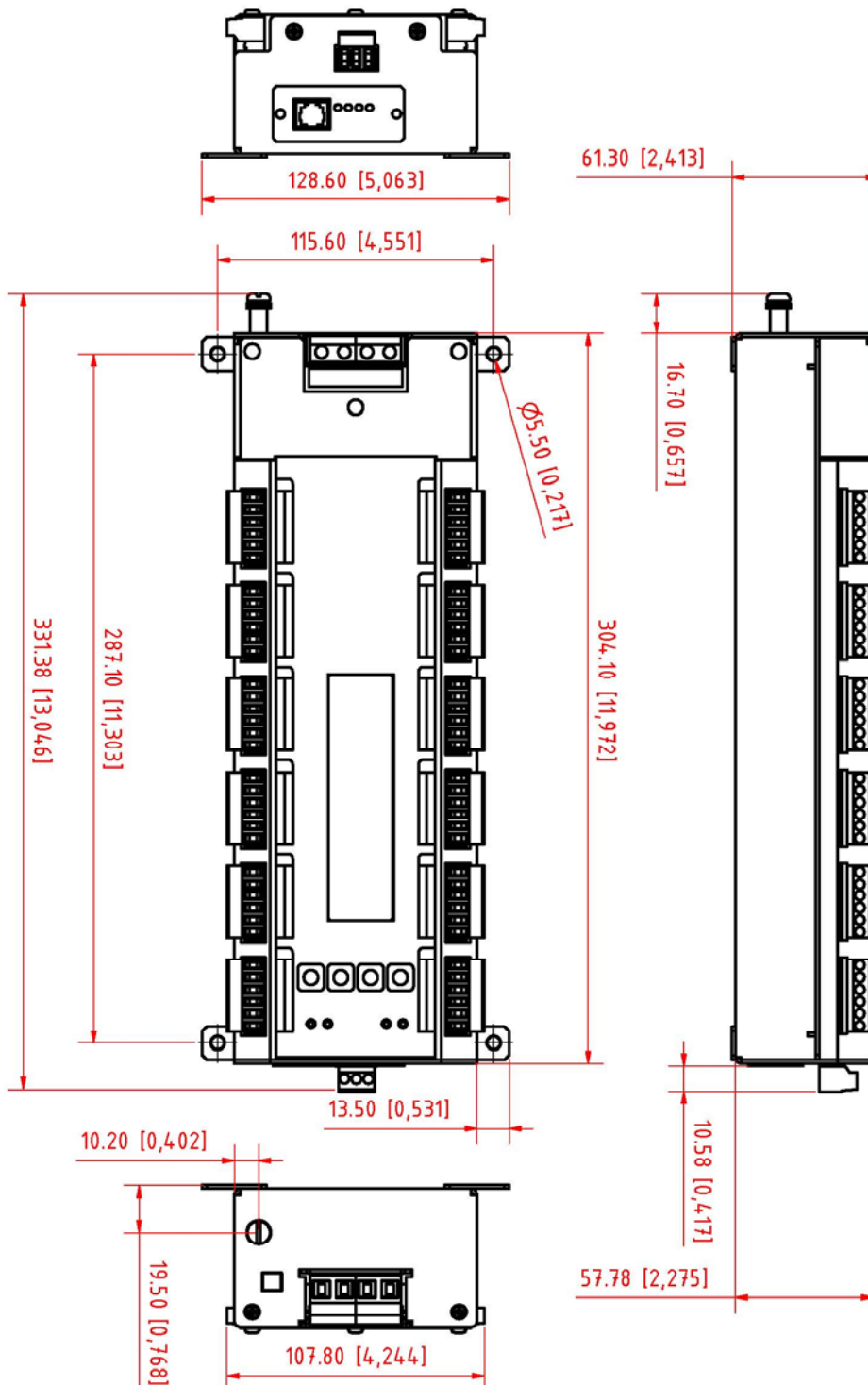
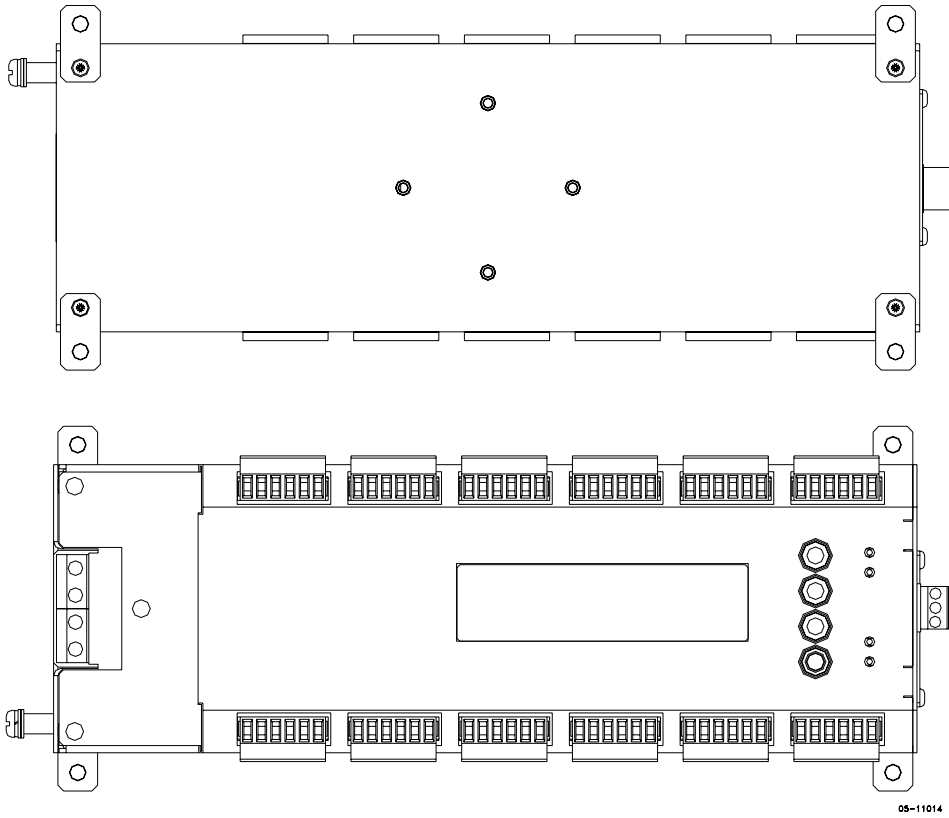
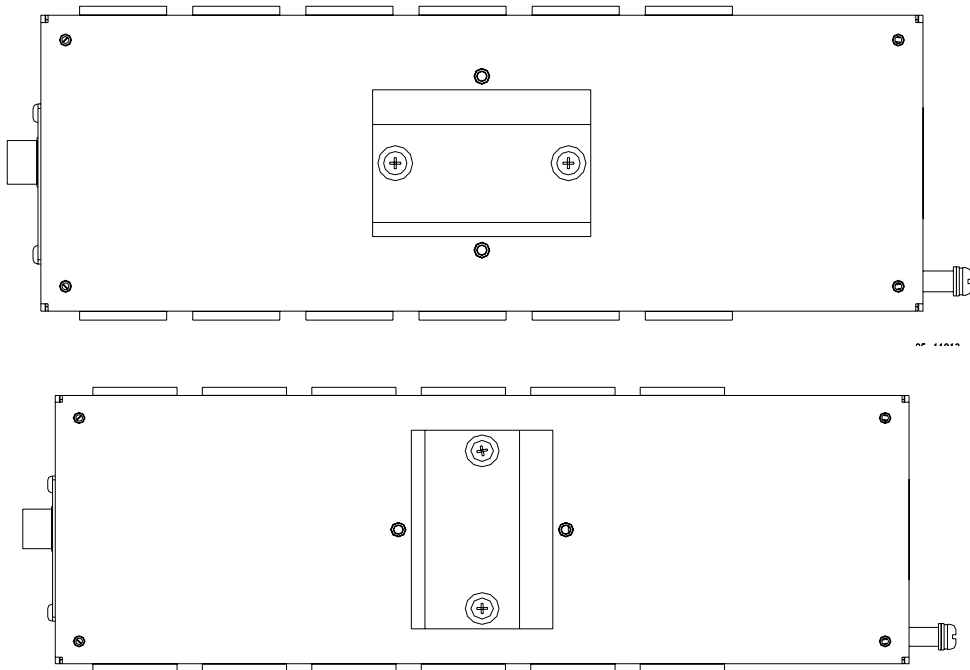


Figure 2-1 BFM036/136 dimensions



**Figure 2-2 Wall mounting**



**Figure 2-3 DIN rail mounting**

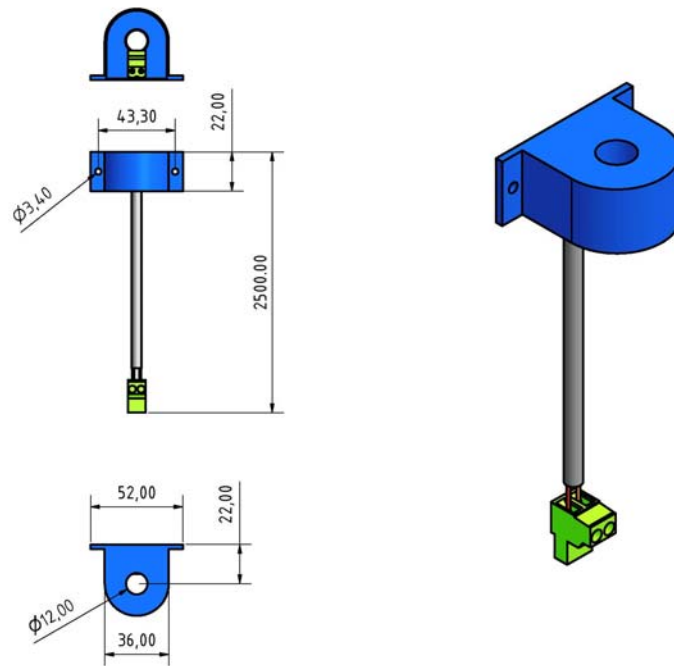


Figure 2-4 Single CT dimensions

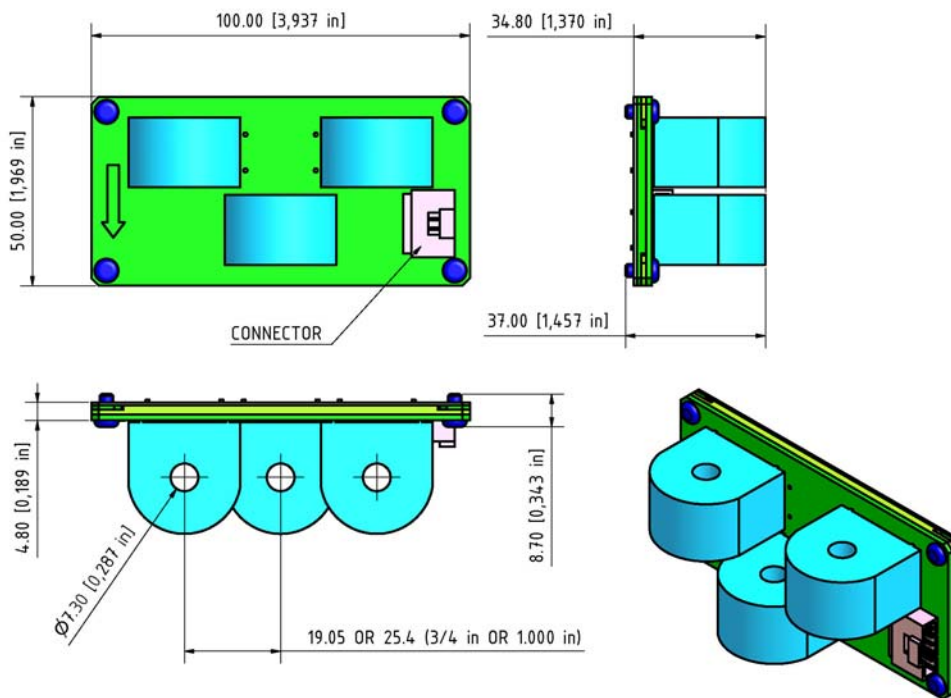


Figure 2-5 3-CTs card dimensions

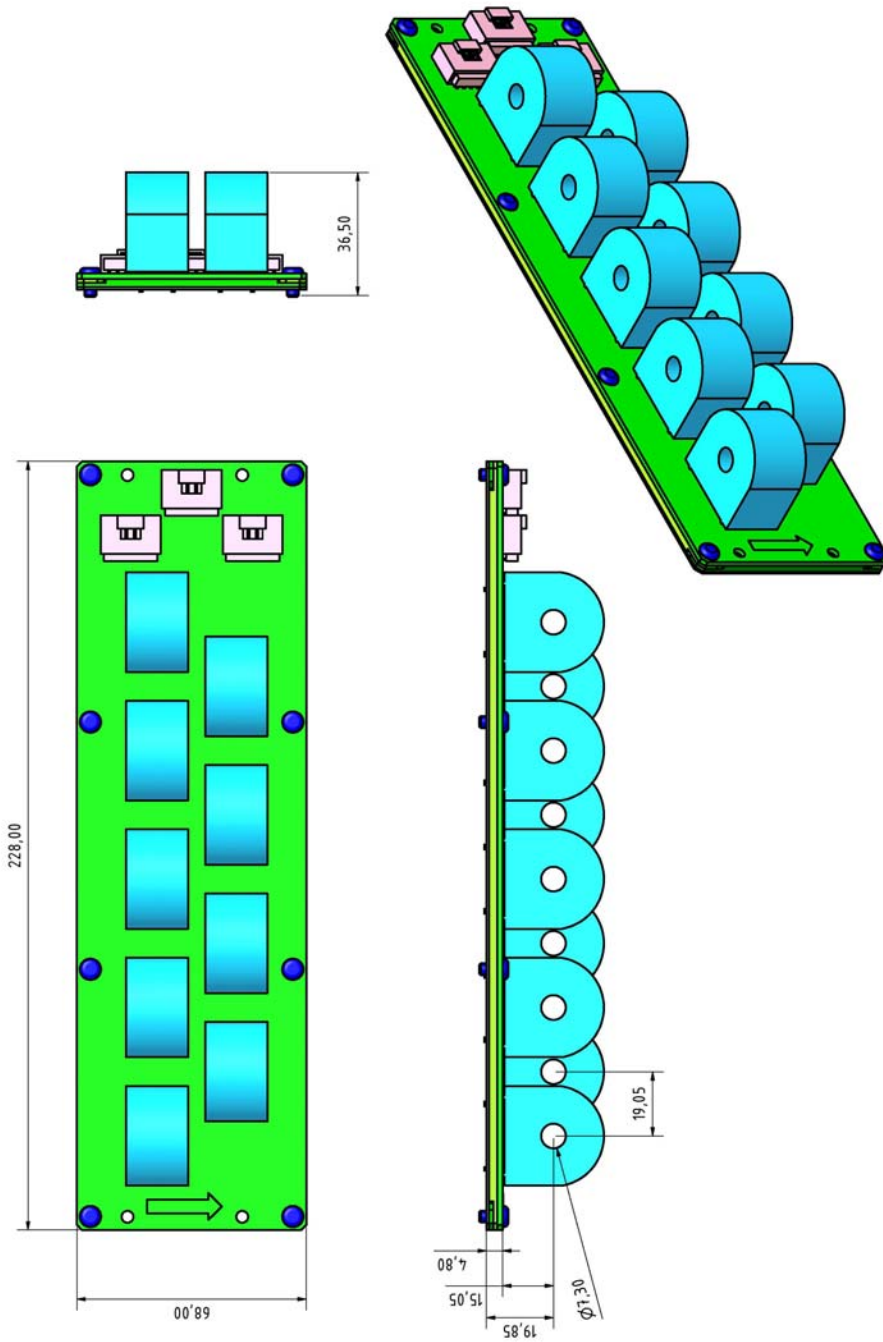
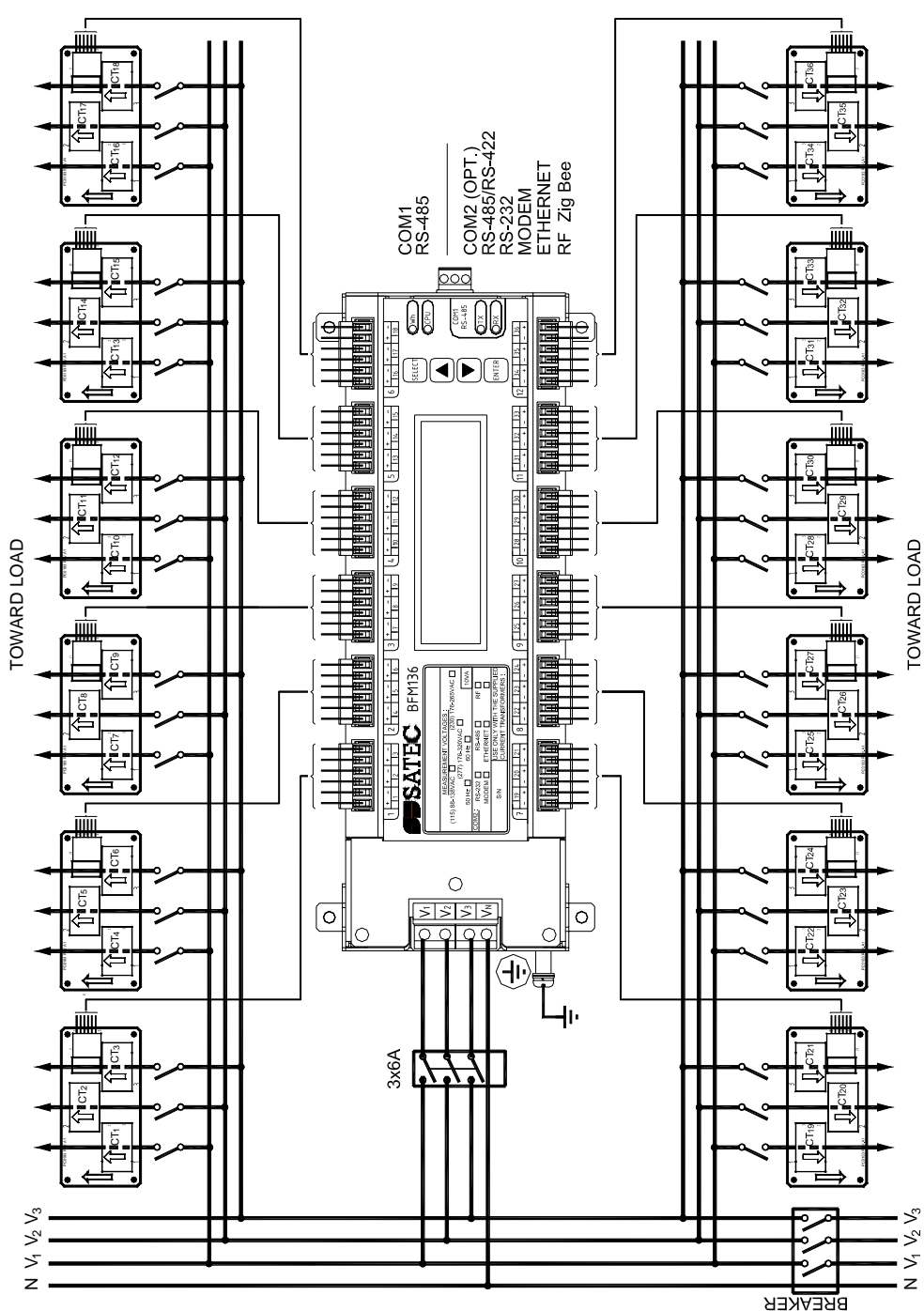


Figure 2-6 9-CTs card dimensions

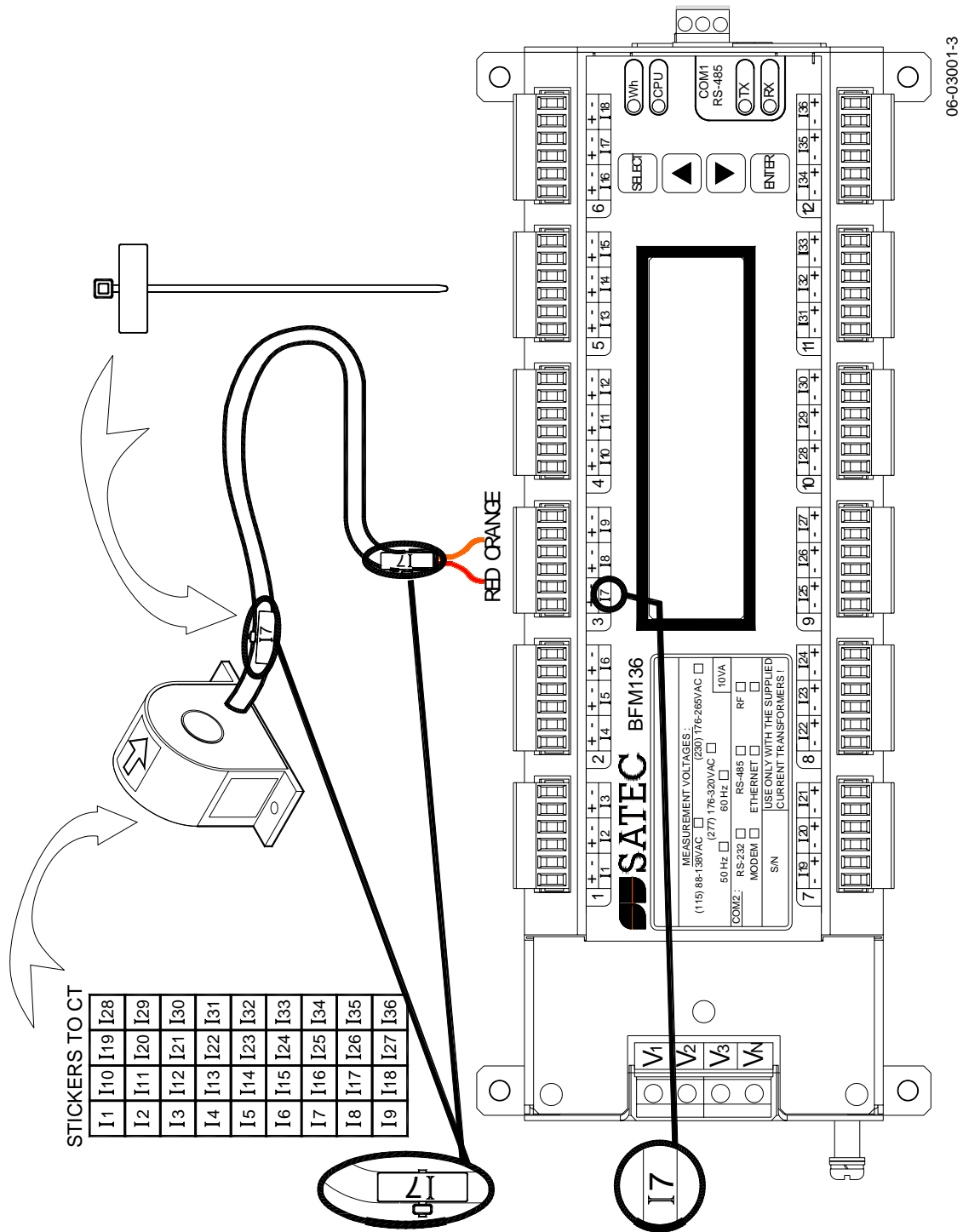
# Electrical Installation

BFM036/136 offers maximum flexibility of current connections by using the variety of CT options and by wiring any CT to any current input of the device. The following drawings present applications serviced by the BFM036/136.

**Before installation ensure that all incoming power sources are shut OFF. Failure to observe this practice can result in serious or even fatal injury and damage to equipment.**



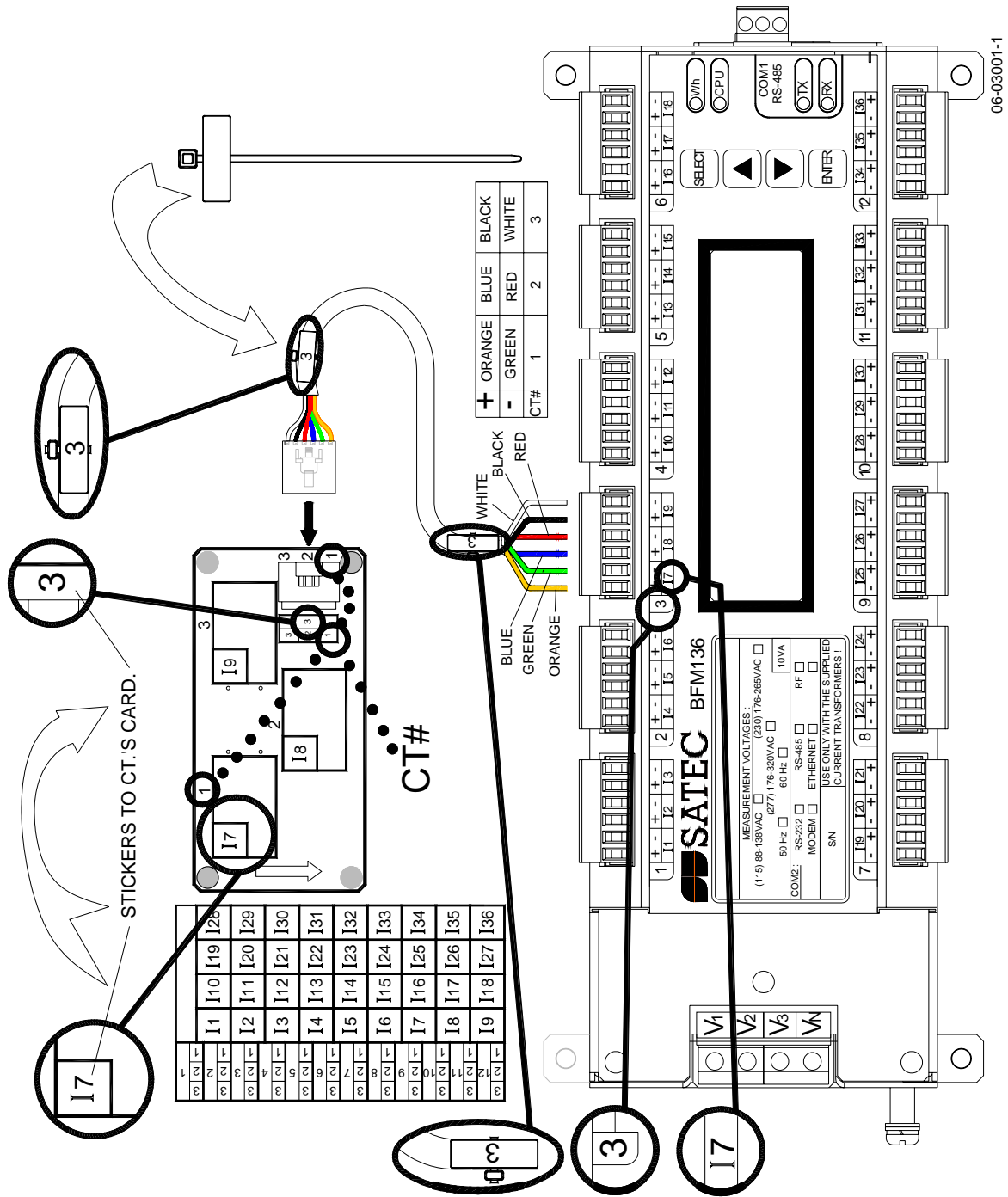
**Figure 2-7 Typical installation**  
(see Safety Requirements on p.17)



**Figure 2-8 Single CT wiring and labeling**

Connect the wires to the + and - inlets according to the following polarity colors:

+	RED
-	ORANGE



06-03001-1

**Figure 2-9 3-CTs card wiring and labeling**

Connect the wires to the + and - inlets according to the following polarity colors:

	CT #1	CT #2	CT #3
+	ORANGE	BLUE	BLACK
-	GREEN	RED	WHITE

It is recommended to mark the cables, CT card terminals, and CTs with the supplied tie markers.





CT stickers I1 through I36 correspond to the BFM036/136 current inputs with matching labels. Cable stickers 1 through 12 correspond to the BFM036/136 current terminal blocks with matching labels.

Use the table from Appendix B to annotate your input assignments and wiring connections.

**Labeling example (see Figure 2-10):**

Assume you want to connect three CTs from block C on your CT card (marked as 1, 2, and 3 on the block C terminal) to the device terminal block 3 so these three CTs would be connected to the device inputs I7, I8, and I9 respectively:

1. Take a CT connection cable, attach a tie wrap marker to each side of the cable and mark them as 3 to indicate that it should be connected to the device terminal block 3.
2. Put the CT block label sticker "3: I7, I8, I9" near CT block C on your CT card to indicate that cable 3 should be connected to this block, and the three CTs connected to the block will be attached to the device current terminals I7, I8, and I9.
3. Put the CT label stickers I7, I8, and I9 directly on CTs 1, 2, and 3 in block C on your CT card to indicate that these CTs will be associated with the device current terminals I7, I8, and I9.
4. Connect the open end wires on your connection cable 3 to the device terminal block 3 terminals using the following polarity color code:
  - CT1: Orange+, Green-
  - CT2: Blue+, Red-
  - CT3: Black+, White-
5. Finally, attach the cable 3 connector to the CT block C terminal on your CT card.

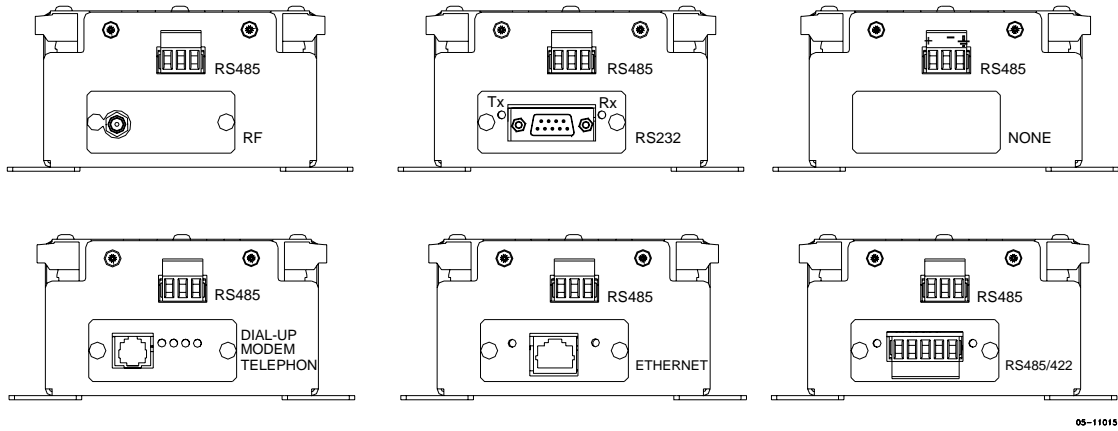
**Safety Requirements**

To ensure safety requirements the BFM036/136 must be grounded - the protective ground terminal (see Figure 2-7) should be connected to protective earth with a copper conductor or strap with minimal length (less than 1 m desirable) and cross-section 5.3 mm<sup>2</sup> (AWG10) at least.

The properly marked external 3-pole disconnect device with circuit-breaker and a fuse 6A, 600V in every pole should be installed between voltage measurement terminals and power lines, located as close as possible (less than 2 m recommended) to the BFM036/136.

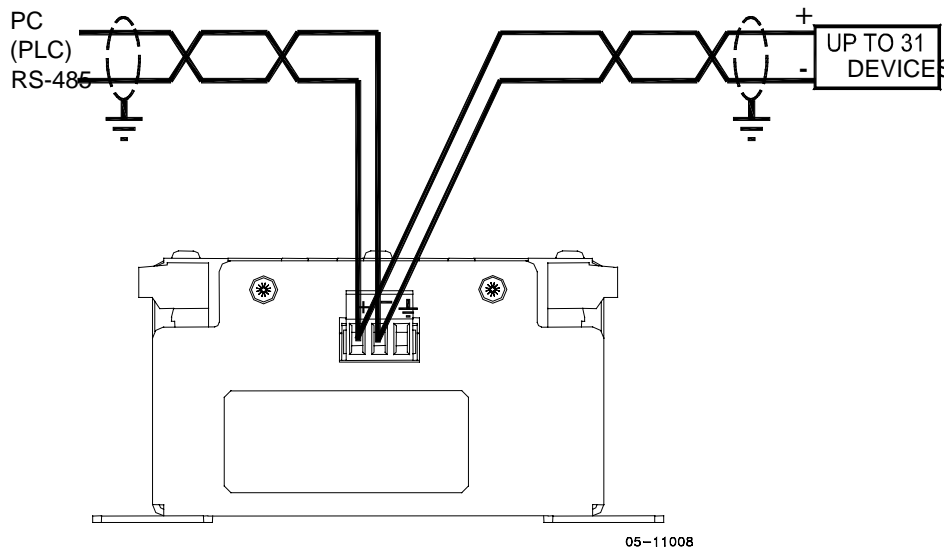
# Communications

Several communication options are available for the BFM036/136.

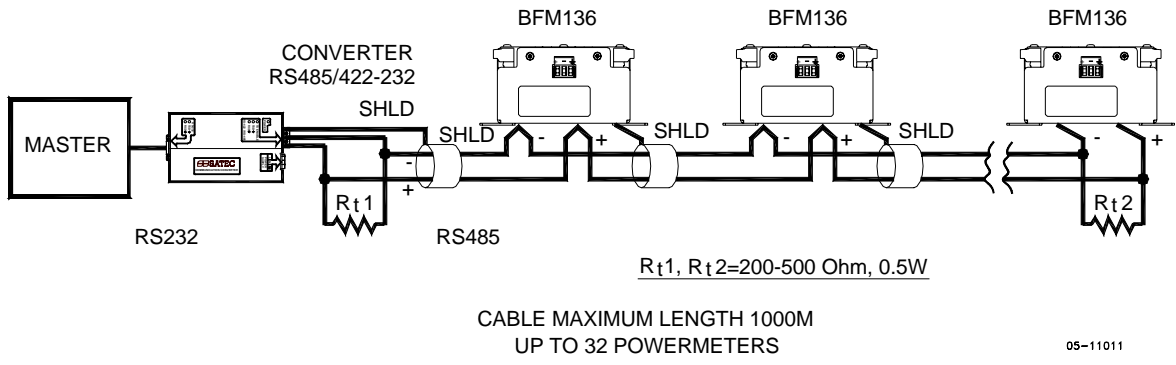


**Figure 2-11 Communication options**

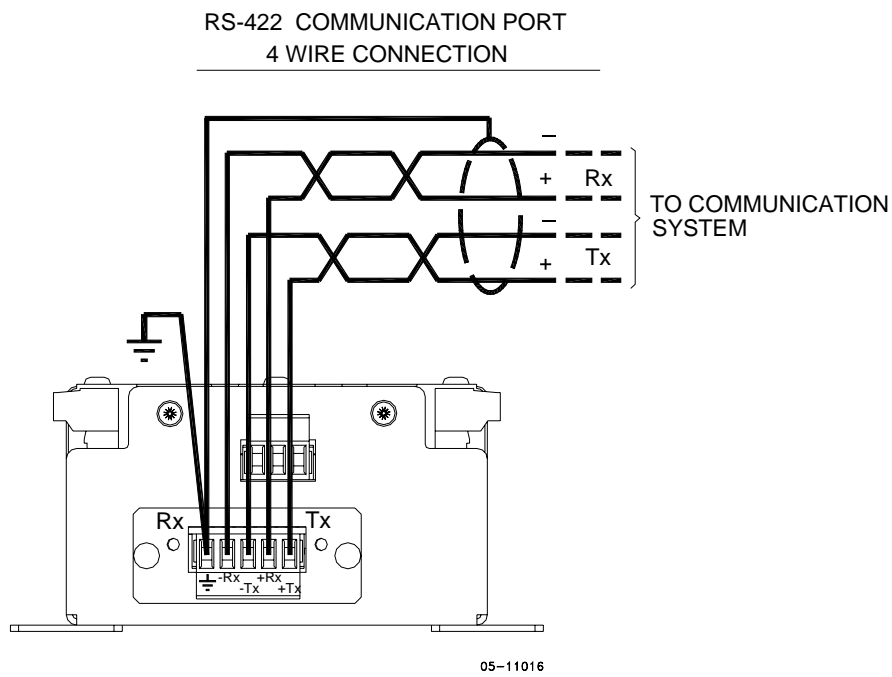
## RS-485 Connection



**Figure 2-12 RS-485 2-wire connection**

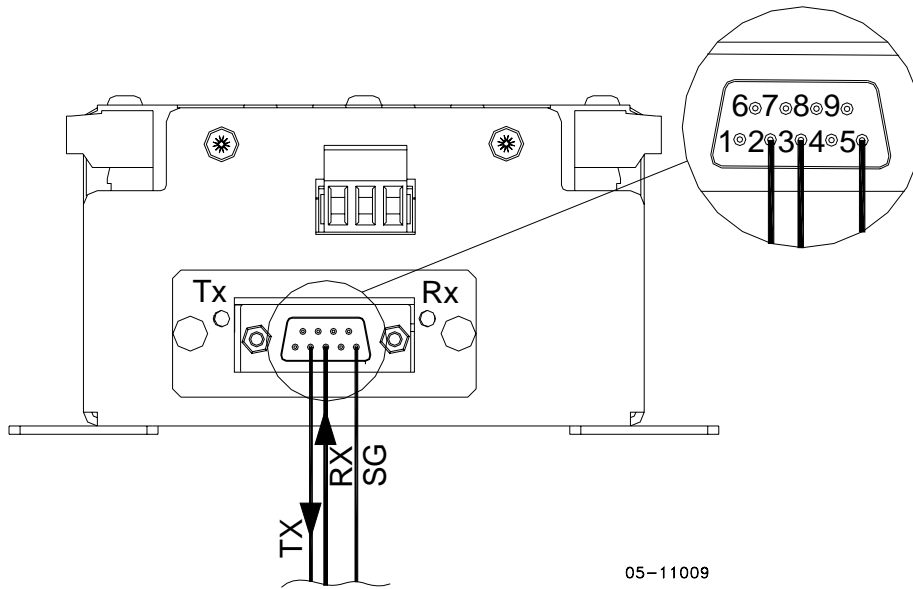


**Figure 2-13 RS-485 multidrop connection**



**Figure 2-14 RS-422/485 4-wire connection**

**RS232 Connection**



**Figure 2-15 RS-232 connection**

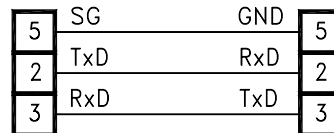
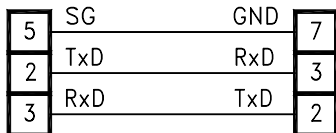
COMPUTER CONNECTIONS RS-232

EM610  
RS232  
MALE CON.

IBM PC/COMPATIBLE  
25-PIN DB25  
FEMALE CON.

EM610  
RS232  
MALE CON.

IBM PC/COMPATIBLE  
9-PIN DB9  
FEMALE CON.



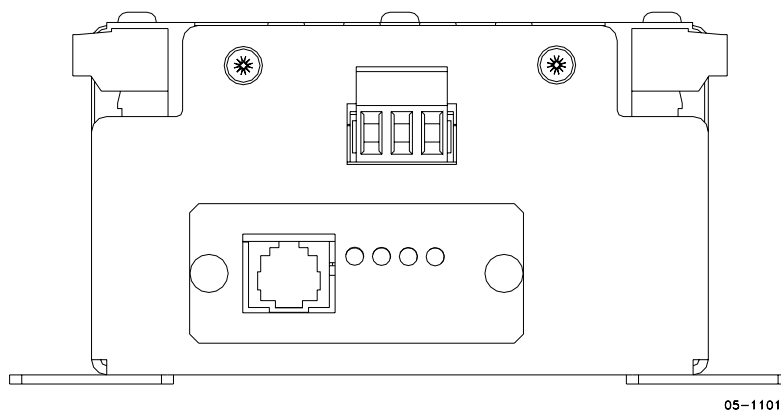
RS-232 SIMPLE 3-WIRE  
CONNECTION 25-PIN

RS-232 SIMPLE 3-WIRE  
CONNECTION 9-PIN

05-08004-5A

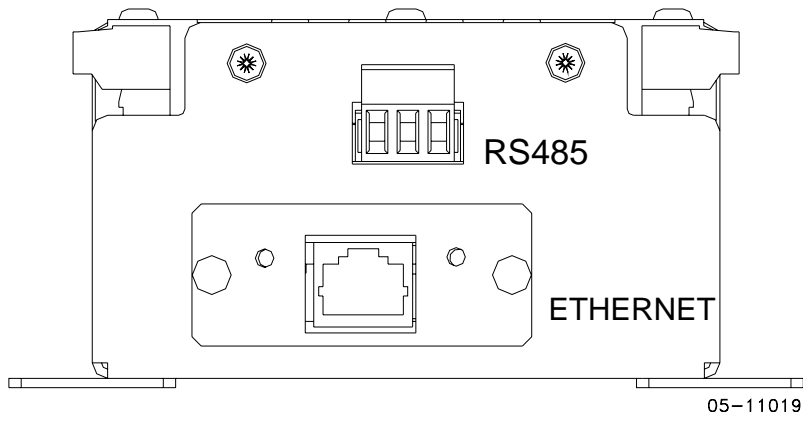
**Figure 2-16 RS-232 cable drawings**

**Modem Connection**

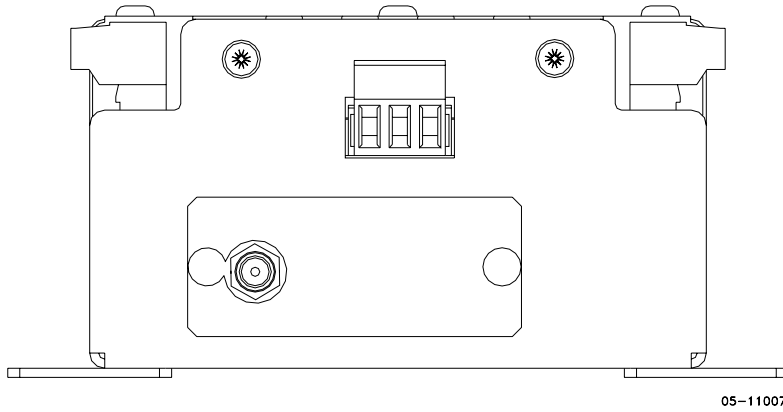


05-11010

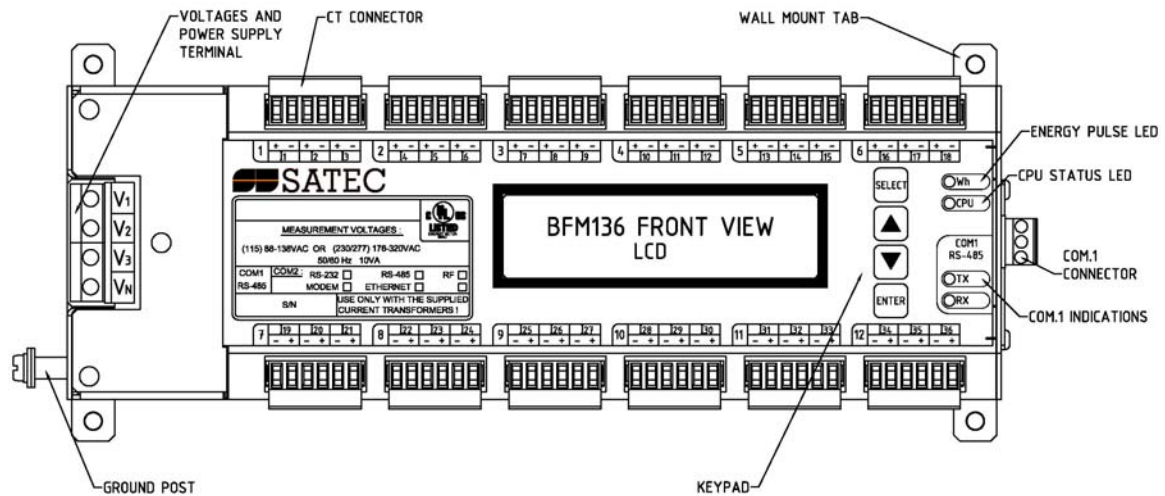
**Ethernet Connection**



**RF ZigBee**



## Controls and Indicators



**Figure 2-17 BFM036/136 Front View**

### Indicator LEDs

The flashing yellow CPU LED shows that the device is operational and is functioning normally.

The green TX and RX LEDs indicate activity on the COM1 communication port. The LEDs flash when the port is receiving or transmitting data.

### Energy Pulse LED

The red “Wh” LED flashes at a user-programmed rate when a load is applied to the device. In normal mode, the LED pulses indicate imported Wh for a selected submeter. In energy test mode, the LED pulses indicate either imported Wh, or imported (inductive) varh for a selected submeter. Energy test mode is used for testing the device energy measurement accuracy. In test mode, the energy and demand accumulators do not account for consumed energy.

See [Device Options](#) in Chapter 3 and [General Meter Setup](#) in Chapter 4 on how to put the device into energy test mode and how to select the LED pulse rate and a submeter for testing.

### Front Panel Display

The BFM136 is provided with an LCD display and four push buttons that are used for local meter reading and setup. See [BFM136 Display Operations](#) in Chapter 3 for information on using the front panel display.

## Device Settings

Before operating your BFM036/136, provide the device with information about your particular environment. The device front display (see [Display Operations \(BFM136\)](#)) and the supplementary PAS software (see [PAS Application Software](#)) allow you to configure the BFM036/136 for your particular use.

### Password

The BFM036/136 configuration setups are secured by a factory-preset password. Contact your dealer for your primary password. Later, you will be able to change the password via the device Access Menu (see [Meter Security](#)).

### Submeter System

The BFM036/136 provides up to 36 submeters with separate measurement and energy registers. Each submeter can service current inputs dedicated to a particular consumer (metering submeter) or be used as a totalization meter for automatic totalization of energy from different sub-consumers (totalization submeter). Additionally, the BFM036/136 provides four more totalization submeters (37 through 40) that you can use for totalization purposes when all 36 metering submeters have been utilized.

A submeter remains inactive while there are no current inputs associated with the submeter (see [Channel Assignments](#)), or until you link another submeter as a source to its energy registers making it a totalization submeter (see [Setting up Total and Tariff Registers](#)). The Channel Assignment setup allows you to link one to three current inputs to each submeter and to specify the primary rating of the current transformers. A totalization submeter provides totalization of energy from any number of metering and totalization submeters.

By default, your device is configured for 12 three-phase metering submeters with 100A (maximum) current inputs (50A nominal rating).

### Submeter Addressing

The BFM036/136 uses the Modbus communication protocol for data transmission and accessing setups through communications. A full description of the communications protocol is found in the BFM036/136 Modbus Reference Guide provided with your device.

Each active submeter in the BFM036/136 is assigned a unique communication address that allows accessing its private registers and setups. All submeter addresses are assigned automatically in a sequential order starting with the device base address that is programmed through the device Communication Setup (see [Setting Up Communication Ports](#)). The following table illustrates submeter addressing in the device with the base address N.

Device Base Address	Submeter Number	Submeter Address
N	SM 1	N
	SM 2	N+1
	...	
	SM 36	N+35
	SM 37	N+36
	...	
	SM 40	N+39

Your device is factory preset to address 1 and occupies the range of addresses 1 through 12, configured for 12 three-phase submeters.

#### NOTES

- Device setup settings, excluding the alarm setpoints and data log setup, are shared across all submeters. Though you can read or write them using any submeter address, your changes affect all submeters in the device.**

2. When using the ExpertPower™ client, submeter address 99 on the Ethernet port COM2 is reserved for the BFM036/136 router and must not fall inside the range of the submeter addresses for this port.

Select your submeters (both metering and totalization) in a sequence without gaps so that your device does not occupy unnecessary network addresses.

If you connect a number of devices to a serial network, allocate a range of addresses for each device so that they do not overlap. For example, if you use three devices with 12 submeters in each one, assign the base address 1 to the first device, the address 13 to the second, and the address 25 to the third device so that they will occupy three non-overlapped address ranges 1 through 12, 13 through 24, and 25 through 36.

## Basic Device Settings

For proper device operation, select the correct power frequency (see [Basic Device Settings](#)) and set the correct primary ratings for device current inputs (see [Channel Assignments](#)) before you connect the device to your network.

## Energy/TOU System

The BFM036/136 provides 4 separate billing energy (total/summary and parallel tariff and maximum demand) registers for each individual submeter. Each register can be linked to any internal energy source or another submeter. The first billing register in your meter is linked to the kWh accumulator by default. Other registers are not operational unless you configure them through the Energy/TOU Setup (see [Configuring Billing Energy and TOU Registers](#)).

## Device Diagnostics

Device diagnostic messages may appear as a result of the BFM036/136 built-in diagnostic tests performed during start-up and device operation. See [Device Diagnostic Codes](#) in Appendix F for the list of diagnostic codes and their meanings.

The device diagnostics status is stored in a non-volatile register, which may be inspected and cleared via PAS, from the meter display or from a user application. All diagnostic events with time stamps are also recorded in the device Event log and can be inspected via PAS (see [Retrieving the Event Log](#) in Chapter 4).

See [Diagnostics Display](#) and [Reset](#) in Chapter 3 on how to inspect and clear the device diagnostics status from the display. See [Viewing and Clearing Device Diagnostics](#) in Chapter 4 on how to inspect and clear the device diagnostics status via PAS. Refer to the BFM136 Modbus Reference Guide for the diagnostic register address and layout.

In the event of a device fault, check the fault reason and clear the device diagnostics. In the event of a time fault, update the device clock. In the event of a configuration reset, check the setup affected by the fault via the device Event log, and then verify the setup data.

Hardware failures are normally non-critical recoverable faults that do not cause a system failure but may cause data loss. Hardware failures are often caused by excessive electrical noise in the region of the device.

If the device continuously resets itself, contact your local distributor.



# Chapter 3 BFM136 Display Operations

## Startup Diagnostics

After applying power to the meter, a start-up diagnostic message is displayed for one second. “Power Up” indicates a normal power-up sequence. You can observe the list of device diagnostic codes recorded during restart and device operation via the [Status Display](#).

See [Device Diagnostic Codes](#) in Appendix F for the list of diagnostic messages.

## Display Features

The multifunctional 2x16 alphanumeric LCD display with backlight allows easy read outs of the measurement parameters both in the dark and under sunlight. The menu-driven multi-page display allows viewing numerous measurement parameters by scrolling through display screens and pages.

### Submeter Displays

In display mode, the display shows readings for the currently selected submeter. Its number is indicated at the upper-left corner of the display. To scroll through active submeters, press and hold the SELECT button, and then use the UP/DOWN buttons to move to another submeter.

### Display Update

The display is updated by default once per second; you can adjust the display update rate via the Display Setup Menu.

### Auto Return

If no buttons are pressed for 5 minutes and the display Auto Return option is not disabled, the display will automatically return to the real-time screen mode from any other measurement display or programming mode. The Auto Return option can be disabled through the Display Setup Menu.

### Auto Scroll

If no buttons are pressed for 30 seconds while the display is in the real-time screen mode, and the Auto Scroll option is enabled in the BFM136, the measurement display will scroll automatically through all submeters. The scroll interval can be adjusted through the Display Setup Menu. To stop auto scrolling, press any button.

### Backlight

If no buttons are pressed for 1 minute, the BFM136 turns the backlight off. To restore the backlight, press any button briefly.

## Navigation Buttons

The BFM136 has four push buttons that are normally used to navigate between screen modes and pages. In programming mode, the buttons allow you to navigate through device setup menus and to change the device settings.

The SELECT button functionality:

- In display mode  
Hold down the SELECT button, and then use the UP or DOWN button to scroll through the submeters.



Press the SELECT button for more than 5 seconds to enter programming mode.

- In programming mode

Press briefly the SELECT button to highlight/activate a menu item or to highlight a digit for changing when entering numbers.

The UP and DOWN buttons functionality:

- In display mode

Press briefly the UP or DOWN button to scroll through the display pages.

Hold down the SELECT button and then press briefly the UP or DOWN button to scroll through the submeters.

Press the UP and DOWN buttons together to move to the default display page.

- In programming mode

Use the UP and DOWN buttons to scrolls through the menu options or to change a selected digit when entering numbers.

The ENTER button functionality:

- In display mode

Press briefly the ENTER button to scrolls through the different screen modes

- In programming mode

Press briefly the ENTER button to select a highlighted menu item and to enter a submenu, or to store a changed item.

## Display Views

The BFM136 display has 5 multi-page screen modes for viewing numerous measurement parameters shown in the following tables. Scroll through the screen modes by briefly pressing the ENTER button. Scroll through the display pages within the selected mode by briefly pressing the UP and DOWN buttons.

Summary/TOU Energy		
Page No	Page content	Description
1	<b>Reg.1 kWh</b> <b>Trf.1 32.535</b>	KWH Tariff 1
2	<b>Reg.1 kWh</b> <b>Trf.2 7.465</b>	KWH Tariff 2
3	<b>Reg.1 kWh</b> <b>Trf.3 0.535</b>	KWH Tariff 3
4	<b>Reg.1 kWh</b> <b>Trf.4 0.465</b>	KWH Tariff 4
5	<b>Reg.1 kWh</b> <b>Tot. 41.000</b>	KWH Total
6	<b>Reg.2 kvarh</b> <b>Trf.1 0.100</b>	kvarh Tariff 1
7	<b>Reg.2 kvarh</b> <b>Trf.2 0.117</b>	kvarh Tariff 2
8	<b>Reg.2 kvarh</b> <b>Trf.3 0.235</b>	kvarh Tariff 3
9	<b>Reg.2 kvarh</b> <b>Trf.4 0.050</b>	kvarh Tariff 4
10	<b>Reg.2 kvarh</b> <b>Tot. 0.502</b>	Kvarh Total
11	<b>Reg.3 kVAh</b> <b>Trf.1 32.535</b>	kVAh Tariff 1

Summary/TOU Energy		
Page No	Page content	Description
12	<b>Reg.3 kVAh</b> <b>Trf.2 7.469</b>	kVAh Tariff 2
13	<b>Reg.3 kVAh</b> <b>Trf.3 0.584</b>	kVAh Tariff 3
14	<b>Reg.3 kVAh</b> <b>Trf.4 0.468</b>	kVAh Tariff 4
15	<b>Reg.3 kVAh</b> <b>Tot. 41.523</b>	kVAh Total



Real Time Measurements		
Page No	Page content	Description
1	<b>V1 120.5 V</b>	Volts
2	<b>V2 120.5 V</b>	Volts
3	<b>V3 120.5 V</b>	Volts
4	<b>V L12 208.1 V</b>	Line to line volts
5	<b>V L23 208.1 V</b>	Line to line volts
6	<b>V L31 208.1 V</b>	Line to line volts
7	<b>I1 neg 5.58 A</b>	Amps. The <b>neg</b> label appears in the case of a reverse current connection.
8	<b>I2 neg 7.70 A</b>	Amps. The <b>neg</b> label appears in the case of a reverse current connection.
9	<b>I3 neg 5.58 A</b>	Amps. The <b>neg</b> label appears in the case of a reverse current connection.
10	<b>Tot. kW 1.558</b>	Total kW
11	<b>Tot. PF 0.997</b>	Total power factor
12	<b>Tot. kVA 1.601</b>	Total kVA
13	<b>Tot. kvar 0.097</b>	Total kvar
14	<b>Freq. 60.00 Hz</b>	Frequency
15	<b>V1.Ang 0.0</b> <b>I1. Ang 0.0</b>	Phase 1 angles
16	<b>V2. Ang -120.0</b> <b>I2. Ang -120.0</b>	Phase 2 angles
17	<b>V3. Ang 120.0</b> <b>I3. Ang 120.0</b>	Phase 3 angles



Summary/TOU Max. Demands		
Page No	Page content	Description
1	<b>Reg.1 MD kW</b> <b>Trf.1 32.535</b>	KW maximum demand Tariff 1
2	<b>Reg.1 MD kW</b> <b>Trf.2 7.465</b>	KW maximum demand Tariff 2
3	<b>Reg.1 MD kW</b> <b>Trf.3 0.535</b>	KW maximum demand Tariff 3
4	<b>Reg.1 MD kW</b> <b>Trf.4 0.465</b>	KW maximum demand Tariff 4
5	<b>Reg.1 MD kW</b> <b>Tot. 41.000</b>	KW maximum demand Total

Summary/TOU Max. Demands		
Page No	Page content	Description
6	<b>Reg.2 MD kvar Trf.1 0.100</b>	kvar maximum demand Tariff 1
7	<b>Reg.2 MD kvar Trf.2 0.117</b>	kvar maximum demand Tariff 2
8	<b>Reg.2 MD kvar Trf.3 0.235</b>	kvar maximum demand Tariff 3
9	<b>Reg.2 MD kvar Trf.4 0.050</b>	kvar maximum demand Tariff 4
10	<b>Reg.2 MD kvar Tot. 0.502</b>	kvar maximum demand Total
11	<b>Reg.3 MD kVA Trf.1 32.535</b>	kVA maximum demand Tariff 1
12	<b>Reg.3 MD kVA Trf.2 7.469</b>	kVA maximum demand Tariff 2
13	<b>Reg.3 MD kVA Trf.3 0.584</b>	kVA maximum demand Tariff 3
14	<b>Reg.3 MD kVA Trf.4 0.468</b>	kVA maximum demand Tariff 4
15	<b>Reg.3 MD kVA Tot. 41.523</b>	kVA maximum demand Total



Total Energy and Maximum Demand Registers		
Page No	Page content	Description
1	<b>Total kWh: 124100.0</b>	Total kWh
2	<b>Total kvarh: 124.0</b>	Total kvarh
2	<b>Total kVA: 124100.0</b>	Total kVAh
3	<b>Max.Dmd kW 25.588</b>	Total kW maximum demand
4	<b>Max.Dmd kvar 4.709</b>	Total kvar maximum demand
5	<b>Max.Dmd kVA 26.017</b>	Total kVA maximum demand
6	<b>Max.Dmd I1, A 15.58</b>	Ampere maximum demand
7	<b>Max.Dmd I2, A 15.58</b>	Ampere maximum demand
8	<b>Max.Dmd I3, A 15.58</b>	Ampere maximum demand
9	<b>Max.Dmd V1, V 120.5</b>	Volt maximum demand
10	<b>Max.Dmd V2, V 120.5</b>	Volt maximum demand
11	<b>Max.Dmd V3, V 120.5</b>	Volt maximum demand



Service Display		
Page No	Page content	Description
1	<b>Diagnostics 3</b>	Device diagnostics. See <a href="#">Diagnostics Display</a> below.
2	<b>S/N 056456</b>	Device serial number
3	<b>S/W V17.02</b> <b>Boot: V1.0.3</b>	Software version Boot loader version
4	<b>COM1:</b> <b>A1, Bd19.2</b>	COM1 port: address and baud rate
5	<b>COM2: Ethernet</b> <b>192.168.0.203</b>	COM2 port: node address and net ID, or IP address
6	<b>Ph1 Ph2 Ph3</b> <b>I1 I2 I3</b>	Submeter phase current assignments

### Diagnostics Display

The diagnostics display shows a list of the device diagnostic codes recorded as a result of the meter self-test diagnostics. The diagnostics page is only displayed if errors were detected.

See [Device Diagnostic Codes](#) in Appendix F for the list of diagnostic codes and their meanings. See [Device Diagnostics](#) in Chapter 2 for more information on the BFM136 built-in diagnostics. See [Reset](#) in Chapter 3 on how to clear the device diagnostics status from the display.

## Navigating in Menus

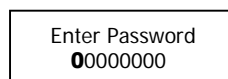
The BFM136 setup is menu-driven. To enter the setup menus, press the SELECT button for more than 5 seconds.

### Entering Numbers

Each digit in numbers is adjusted separately with the UP/DOWN buttons. A brief press on the button increments or decrements the highlighted digit by one. A highlighted digit is flashing twice per second. To move to the next digit, press briefly the SELECT button.

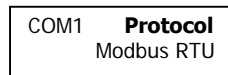
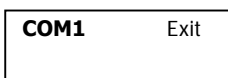
When the number is set to a desired value, press briefly the ENTER button to store your new setting.

### Entering a Password



The setup menus are secured by an 8-digit user password. If the password entered is correct, you will move to the main menu, otherwise you will return to the display mode.

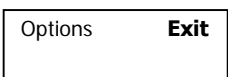
### Selecting Menus



The main menu is represented by two entries; the left item shows a menu list, while the right item is an assisting exit window that allows easy returning to the display mode. Flashing highlights a currently active menu item (in the following diagrams, a highlighted item is pointed out by using a bold font). To highlight a desired menu item, press briefly the SELECT button.

To select a menu entry from the menu list:

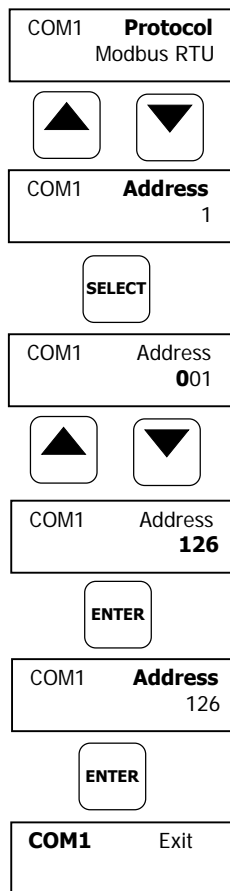
1. Highlight the left item by briefly pressing the SELECT button if it is not highlighted yet.
2. Scroll through the menu list by briefly pressing the UP and DOWN buttons until the desired menu entry appears.
3. Press the ENTER button.



To exit the main menu:

1. Highlight the Exit item by briefly pressing the SELECT button.
2. Press the ENTER button.

## Viewing and Changing Setup Items



A second level menu normally consists of three items: the upper-left static item indicates the menu name, while the upper-right item represents a list of setup parameters you can scroll through, and the lower item shows the present parameter value.

To select a parameter you want to view or change:

1. Highlight the upper-right item by briefly pressing the SELECT button if the item is not highlighted yet.
2. Scroll through the parameter list with the UP/DOWN buttons until the desired parameter name appears.

To change the selected parameter:

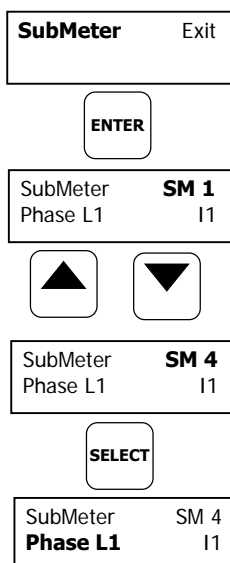
1. Press the SELECT button briefly to highlight the lower item.
2. If a number represents the parameter value, highlight a desired digit by briefly pressing the SELECT button, then adjust the digit to the desired value by the UP and DOWN buttons.
3. If a name represents the parameter value, select the desired value by the UP and DOWN buttons.
4. Press the ENTER button to store your selection. You return to the parameter list to select another parameter or return to the main menu.

To exit the menu:

1. Highlight the menu name (upper-left item) by pressing briefly the SELECT button.
2. Press the ENTER button.

## Menu Operations

### Submeter Channel Assignments



This menu allows you to link the device current terminals to submeters so they can monitor them. Additionally, the menu allows you to specify the primary current rating of the current transformers connected to the device terminals. The number of the selected current inputs for a submeter specifies if it will be a single-, two-, or three-phase meter.

**Always select your submeters in a sequence without gaps so that your device does not occupy unnecessary network addresses.**

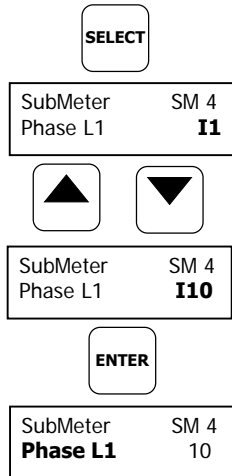
To enter the menu, select the SubMeter entry from the main menu, and then press the ENTER button.

To select a parameter you want to view or change:

1. Highlight the upper-right item by using the SELECT button.
2. Select the submeter you wish to configure with the UP/DOWN buttons.
3. Highlight the lower-left item by briefly pressing the SELECT button.
4. Scroll through the parameter list with the UP/DOWN buttons until the desired parameter name appears.

To change the selected parameter:

1. Highlight the lower-right item by using the SELECT button.



2. To link a current input to a submeter, select the desired input ID with the UP/DOWN buttons.
3. To change the CT primary rating, highlight desired digits by briefly pressing the SELECT button, then adjust them to the desired value with the UP/DOWN buttons.
4. Press the ENTER button to store your selection. You return to the parameter list to select another parameter or return to the main menu.

To exit the menu, highlight the menu name (upper-left item) with the SELECT button, and then press the ENTER button.

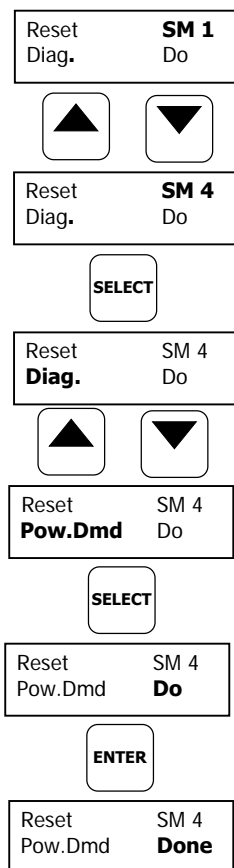
The following table lists available options.

Label	Parameter	Options	Default	Description
<b>Phase L1</b> <b>Phase L2</b> <b>Phase L3</b>	Phase current input terminal number	I1-I36, None = not connected	See note <sup>1</sup>	Links a current input terminal to the corresponding submeter's phase voltage input V1, V2 or V3
<b>CT</b>	CT primary current <sup>2</sup>	1-10000 A	50 A	Specifies the primary rating of the submeter current transformers

<sup>1</sup> The device is pre-configured for twelve three-phase submeters.

<sup>2</sup> Specify the CT ratings assuming a ×200% device inputs overrange. The device inputs are preset for 100A current transformers with a 50A primary rating.

### Reset



This menu allows you to reset maximum demands in each submeter and to clear the device diagnostics.

To enter the menu, select the Reset entry from the main menu, and then press the ENTER button.

To reset the desired registers:

1. Highlight the upper-right item by briefly pressing the SELECT button.
2. Select the submeter you are going to clear with the UP/DOWN buttons.
3. Highlight the lower-left item by pressing the SELECT button.
4. Scroll through the list with the UP/DOWN buttons until the desired entry appears.
5. Press the SELECT button to highlight the lower-right item.
6. Press and hold the ENTER button for 5 seconds. The “Do” entry is replaced with “Done” showing the operation is complete.

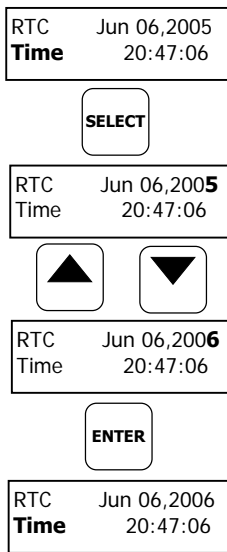
To exit the menu, highlight the menu name (upper-left item) with the SELECT button, and then press the ENTER button.

The following table lists reset options.

Label	Parameter
<b>Diag.</b>	Clears device diagnostics status
<b>Pow.Dmd</b>	Clears maximum power demands
<b>Amp.Dmd</b>	Clears maximum ampere and volt demands
<b>Max.Dmd</b>	Clears all maximum demands



### Real Time Clock Setting



This menu allows you to adjust internal real time clock.

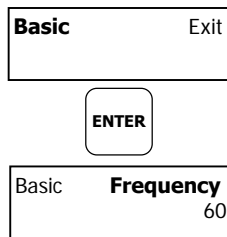
To enter the menu, select the RTC entry from the main menu, and then press the ENTER button.

To adjust the clock:

1. Highlight a time or date item you want to change item by briefly pressing the SELECT button.
2. Adjust the selected item with the UP/DOWN buttons.
3. Highlight the next item you want to change and adjust it in the same manner.
4. To store your new date and time, press the ENTER button. If you confirm the time change while the seconds item is highlighted, the seconds' reading will be zeroed, otherwise seconds stay unchanged.

To exit the menu, highlight the menu name (upper-left item) with the SELECT button, and then press the ENTER button.

### Basic Device Settings



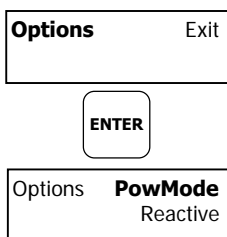
This menu allows you to define the general characteristics of the electrical network.

To enter the menu, select the Basic entry from the main menu, and then press the ENTER button. For instructions on navigating in the menu, see [Viewing and Changing Setup Items](#).

The following table lists available options.

Label	Parameter	Options	Default	Description
<b>Pt</b>	PT Ratio	1.0-6500.0	1.0	The phase potential transformer's primary to secondary ratio
<b>Frequency</b>	Nominal frequency	50, 60 Hz	60 Hz	The nominal power frequency
<b>PowDmdPer</b>	Block power demand period	1, 2, 5, 10, 15, 20, 30, 60 min	30	The length of the demand period for power demand calculations
<b>Num.Per.</b>	The number of blocks in the sliding window	1-15	1	The number of blocks to be averaged for sliding window demands
<b>VDmnPer.</b>	Volt demand period	0-9000 sec	900	The length of the demand period for volt demand calculations
<b>ADmdPer.</b>	Ampere demand period	0-9000 sec	900	The length of the demand period for ampere demand calculations

### Device Options



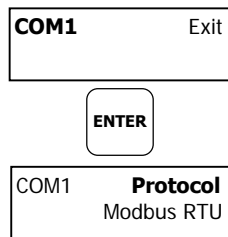
This menu allows you to select some user-configurable device options or put the BFM036/136 into energy test mode.

To enter the menu, select the Options entry from the main menu, then press ENTER. For instructions on navigating in the menu, see [Viewing and Changing Setup Items](#).

The following table lists available options.

Label	Parameter	Options	Default	Description
<b>PowMode</b>	Power calculation mode	Reactive, NonActive (non-active power)	Reactive	The method used for calculating reactive and apparent powers
<b>ErgyRoll</b>	Energy roll value	100000.0-100000000.0 kWh	100000000.0	The value at which energy counters roll over to zero
<b>TestMode</b>	Energy test mode	OFF, Wh, varh	OFF	Setting this option puts the device into the energy test mode
<b>PlsConst</b>	Wh LED pulse rate, Wh/pulse	0.01-100.00	5.40Wh/pulse (one equivalent disk revolution)	LED pulse constant - the amount of accumulated energy giving one pulse via "Wh" LED
<b>WhLEDSrc</b>	Energy LED source	1-40, None	1	Selects a submeter as a LED pulsing source

### Communication Ports



These two menus allow you to configure parameters for communication ports COM1 and COM2. The BFM036/136 automatically detects a replaceable communication module and will not allow you to change the baud rate and data format for the Dial-up modem, and for the Ethernet and RF modules.

To enter the menu, select the COM1 or COM2 entry from the main menu, and then press the ENTER button. For instructions on navigating in the menu, see [Viewing and Changing Setup Items](#).

The following table lists available port options.

Label	Parameter	Options	Default	Description
Protocol	Communications protocol	Modbus RTU, Modbus ASCII	Modbus RTU	The communications protocol for the port
Interface	Port interface	RS485, RS485, RS232, Modem, Ethernet, RF	COM1, COM2	Not changeable; automatically detected by the device
Address	Device address	1-247	1	Device's base network address (see <a href="#">Submeter Addressing</a> )
Baud rate	Baud rate	2.4-115.2 kbps	19.2 kbps	The port baud rate
Data/Prtly	Data format and parity	7E, 8N, 8E	8N	7E data format should not be used with the Modbus RTU protocol
Send Delay	Transmission delay	0-1000 ms	5 ms	The minimum time after the last request character is received to start the transmission.
Chr.Tmout	Inter-character timeout	0-1000 ms	4 ms	The maximum time the line is allowed to idle before closing a connection in the Modbus RTU protocol

#### NOTE

When using the ExpertPower™ client (see [Configuring eXpertPower Client](#)), submeter address 99 on the Ethernet port COM2 is reserved for the BFM036/136 router and must not fall inside the range of the submeter addresses for this port.

## Local Network Settings

<b>Net</b>	Exit
ENTER	
Net	<b>IP Address</b> 192.168.000.203

This menu allows you to configure the Ethernet modem (if present) for direct communications through the LAN or the Internet.

To enter the menu, select the Net entry from the main menu, and then press the ENTER button. For instructions on navigating in the menu, see [Viewing and Changing Setup Items](#).

The following table lists available Ethernet options.

Label	Default	Description
IP Address	192.168.0.203	Device IP address
Subnet Mask	255.255.255.0	Subnet mask
Def.Gateway	192.168.0.1	Default gateway

## Local Settings

<b>Local</b>	Exit
ENTER	
Local	<b>Country</b> Default

This menu allows you to configure your local time zone settings.

To enter the menu, select the Local entry from the main menu, and then press the ENTER button. For instructions on navigating in the menu, see [Viewing and Changing Setup Items](#).

The following table lists available options.

Label	Parameter	Options	Default	Description
Country	Country code	Default, or country name	Default	Defines a currency and calendar settings. The default setting stands for the U.S.A.
Daylight	Daylight savings time (DST) option	Disabled, Enabled	Enabled	When DST is disabled, the RTC will operate in standard time only. When enabled, the BFM036/136 will automatically update the time at 2:00 AM at the pre-defined DST switch dates.
DST Mon	DST start month	January-December	April	The date when Daylight Savings Time begins. The DST switch point is specified by the month, week of the month and weekday. By default, DST starts at 2:00 AM on the first Sunday in April of each year.
DST Week	DST start week of the month	First, Second, Third, Fourth, Last	First	
DST Day	DST start day of the week	Sunday-Saturday	Sunday	
End Mon	DST end month	January-December	October	The date when Daylight Savings Time ends. The DST switch point is specified by the month, week of the month and weekday. By default, DST ends at 2:00 AM on the last Sunday in October of each year.
End Week	DST end week of the month	First, Second, Third, Fourth, Last	Last	
End Day	DST end day of the week	Sunday-Saturday	Sunday	

## Meter Security

<b>Access</b>	Exit
ENTER	
Access	<b>Password</b> 9

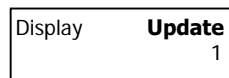
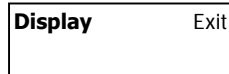
This menu allows you to change the user password and define a level of the device security for accessing the BFM036/136 through communication ports.

To enter the menu, select the Access entry from the main menu, and then press the ENTER button. For instructions on navigating in the menu, see [Viewing and Changing Setup Items](#).

The following table lists available options.

Label	Parameter	Options	Default	Description
Password	User password	0-99999999	Factory set (consult your dealer)	A user password for accessing the device menus. It is effective for the display and for all ports
Com.Pass	Remote password checking	OFF, ON	ON	Controls password checking when the BFM036/136 is accessed through communication ports

## Display Settings



This menu allows you to configure options for the BFM136 display.

To enter the menu, select the Display entry from the main menu, and then press the ENTER button.

For instructions on navigating in the menu, see [Viewing and Changing Setup Items](#).

The following table lists available options.

Label	Parameter	Options	Default	Description
<b>Update</b>	Display update rate	1-10 sec	1 sec	Defines the interval between display updates
<b>Scroll</b>	Auto scroll interval	None, 2-15 sec	None	Defines the scroll interval for the main data display or disables auto scroll
<b>Auto Ret</b>	Auto return to the main screen	Disabled, Enabled	Enabled	Enables automatic return to the main display if no buttons are pressed for 5 minutes
<b>Backlit</b>	Backlight control	Off, On	Off	ON - the backlight is still lights all the time. OFF - the backlight is turned off in 1 minute if no button is pressed.

## Chapter 4 PAS Application Software

The supplemental PAS software can be used for configuring the BFM036/136 through communication ports, for retrieving real-time and energy profile data, and for remote upgrading device firmware.

To run PAS, you need Windows 98, Windows NT, Windows 2000 or Windows XP installed on your computer. PAS will not run properly on Windows 95.

For information on how to install PAS on your PC, see the PAS Getting Started guide supplied on the installation CD.

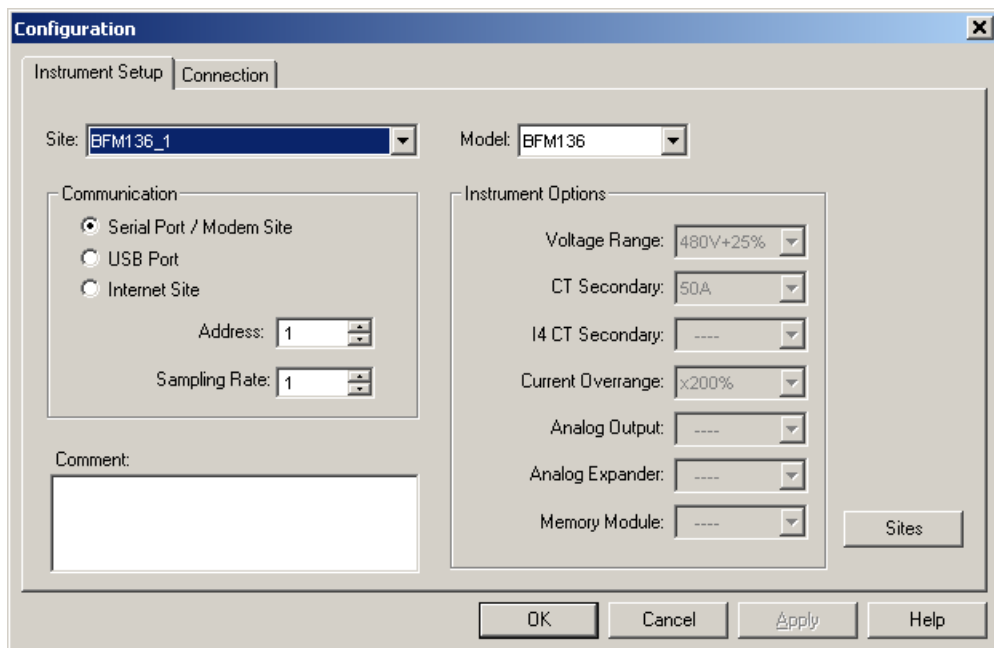
### Setting up your Submeters

Each submeter in your device is accessed using a different communication address (see [Submeter Addressing](#)).

To communicate with your submeters, create a separate site database for each submeter. During configuration, store all setups to the site database so that PAS will recognize your device's properties regardless of whether the device is online or offline.

To create a new database for a submeter:

1. Select Configuration from the Tools menu, and then click the Sites button on the right-hand-side.



2. From the "Look in" box, select the directory where a new database will be stored. By default, it will be the "Sites" directory. Type a site name for the submeter in the "File name" box, click New, and then click OK.
3. On the Instrument Setup tab, select BFM136 in the "Model" box. PAS automatically selects the appropriate instrument options for the submeter.
4. If you wish to add any comments for the submeter, type them into the "Comments" box.

## Setting up Communications

You can communicate with your meter via a local RS-485 serial port, or remotely through a second adjustable communication port. Depending on what was ordered, your meter may be equipped with an RS-232 or RS-422/485 serial port, with a dial-up modem for communicating through public telephone lines, with an Ethernet module for communicating through the Internet, or with an RF modem for wireless communications.

The communication protocol and port settings in PAS must match the settings made in your device.

To configure your communications with the BFM036/136:

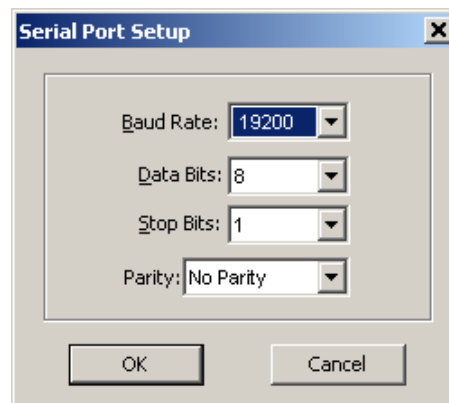
1. Select Configuration from the Tools menu. Under the Communication group on the Instrument Setup tab, select the type of connection for your device.
2. In the Address box, select an appropriate submeter address.
3. In the Sampling Rate box, select a rate at which PAS updates data on your screen when you continuously poll the device via the PAS Data Monitor.

### Communicating through a Serial Port

Select Serial Port/Modem Site on the Configuration tab, and then click on the Connection tab to configure your serial port settings.

#### Configuring a Serial Port

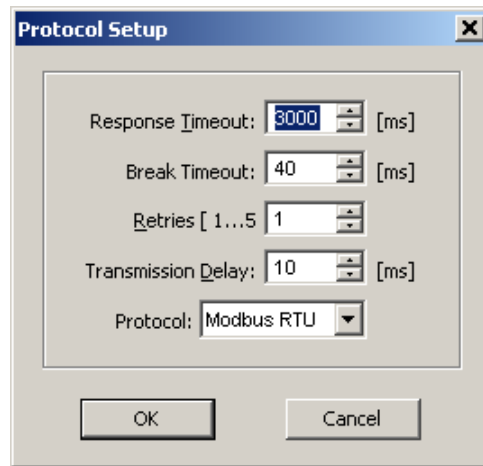
1. On the Connection tab, select a COM port from the Device box, and then click Configure.



2. Specify the baud rate and data format for the port. Choose the same baud rate and data format as you have set in the BFM036/136, and then click OK. The default settings for the local RS-232 and RS-422/485 serial ports are 19200 baud, 8 bits with no parity.

#### Selecting the Communications Protocol

1. On the Connection tab, click Protocol.



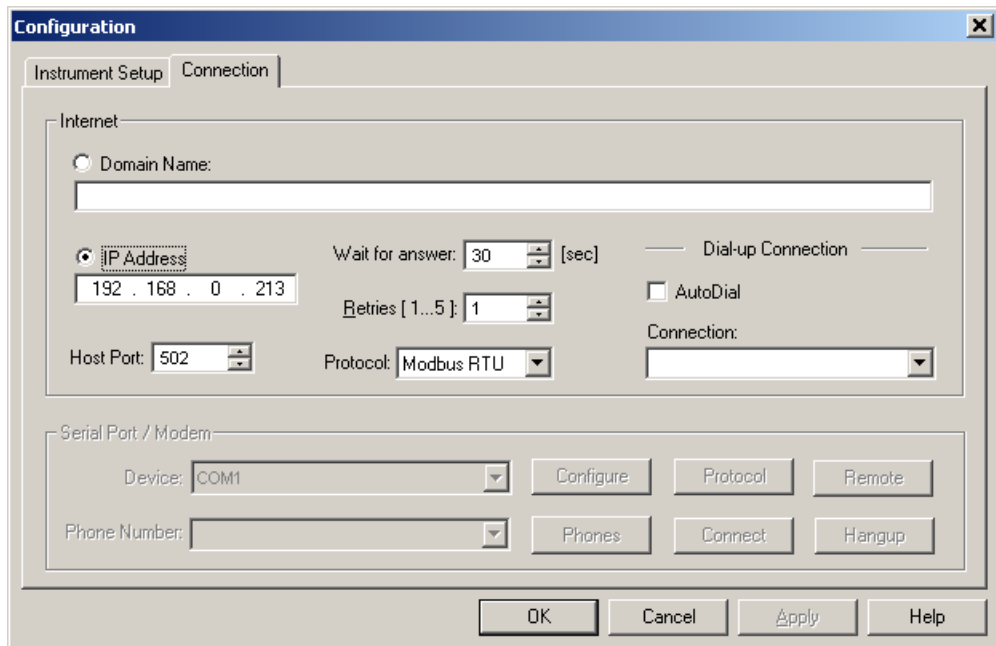
2. In the Protocol box, select the same communications protocol as you have in your BFM036/136. The default protocol setting in the BFM036/136 for all ports is Modbus RTU.

For more information on configuring the protocol parameters, refer to the PAS Getting Started guide.

### Communicating through the Internet

If you are communicating via the Ethernet, define the IP address of your BFM036/136 on the network.

1. On the Instrument Setup tab, select Internet Site.
2. Click on the Connection tab.



3. Click IP address and type in the IP address of your BFM036/136. The factory-set IP address is 192.168.0.203.
4. In the Protocol box, select Modbus RTU. The default host port 502 is set automatically as you select the protocol.
5. In the Wait for answer box, adjust the time that PAS will wait for a connection before announcing an error and the number of retries PAS will use to receive a response from the device if communications fail.

## Preparing Setups

PAS allows you to prepare setup data for your BFM036/136 off-line without the need to have it connected to your PC.

Select the appropriate site from the list box on the PAS toolbar, and then select the desired setup group from the Meter Setup menu. Click on the tab with the setup you want to create or modify, and then fill in the boxes with the desired configuration data. Click the "Save as..." button to store the data to the site database.

To save your setup to another site database, select it from the file pane. Click OK.

To reuse setups from another site, copy them to your present site database. Click Open, select the desired site database, and click OK. The opened setup is copied to your site database.

You can also copy all setups from one site database into another site's database. Select a device site from the list box on the toolbar from which you want to reproduce setups, and then select "Copy to..." from the Meter Setup menu. Select the site database to which to copy setups, and then click OK.

## Downloading Setups

You can update each setup in your BFM036/136 one at a time or download all setups together from the site database.

To update a particular setup, check the On-line button on the PAS toolbar, select a submeter site from the list box on the toolbar, and then select the desired setup group from the Meter Setup menu. Click on the tab of the setup you want to download to the device, and then click Send.

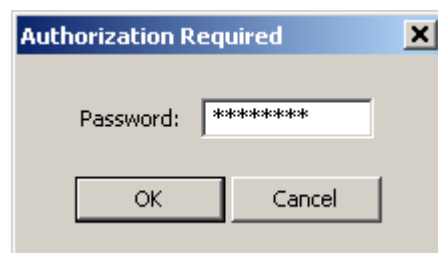
To download all setups at once, check the On-line button on the toolbar, select the submeter site from the list box on the toolbar, and then select Download Setups from the Meter Setup menu.

## Uploading Setups

To upload the setups from the submeter to the site database, check the On-line button on the PAS toolbar, select the submeter site from the list box on the toolbar, and then select Upload Setups from the Meter Setup menu.

## Authorization

If communications with your device is secured, you are prompted for the password when you send new setup data to the BFM036/136.



Enter the password and click OK. If your authorization was successful, you are not prompted for the password again until you close the dialog window.

## Changing Port Settings

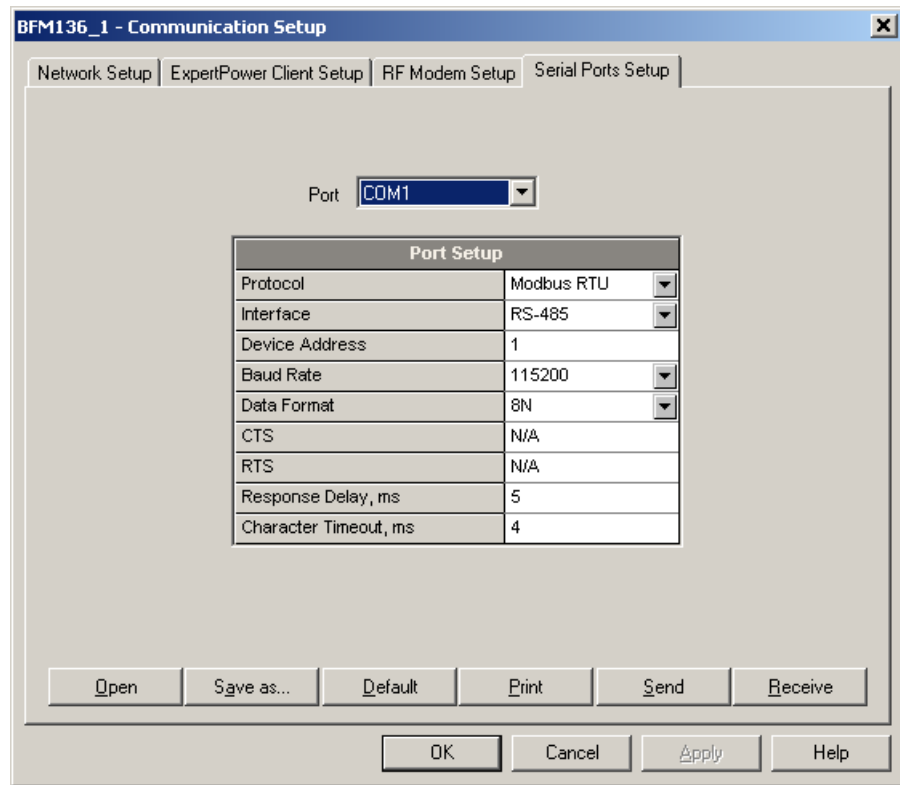
This section describes how to configure communication ports in the BFM036/136 through PAS.

The communication settings affect all submeters in your device.



## Setting Up Communication Ports

To enter the setup dialog, select the site from the list box on the PAS toolbar, select Communications Setup from the Meter Setup menu, and then click on the Serial Ports Setup tab. In the Port box, select the desired device port.



To change the port settings, select desired port parameters, and then click Send. For the available communication options, see [Communication Ports](#) in Chapter 3.

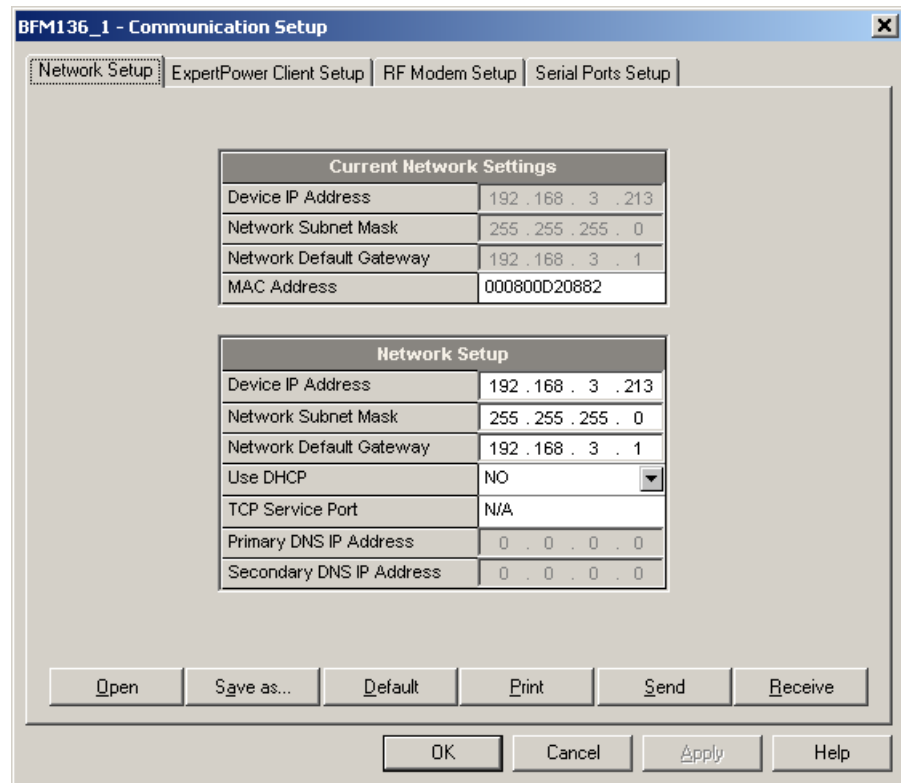
### NOTE

When using the ExpertPower™ client (see [Configuring eXpertPower Client](#)), submeter address 99 on the Ethernet port COM2 is reserved for the BFM036/136 router and must not fall inside the range of the submeter addresses for this port.

## Setting Up the Local Network

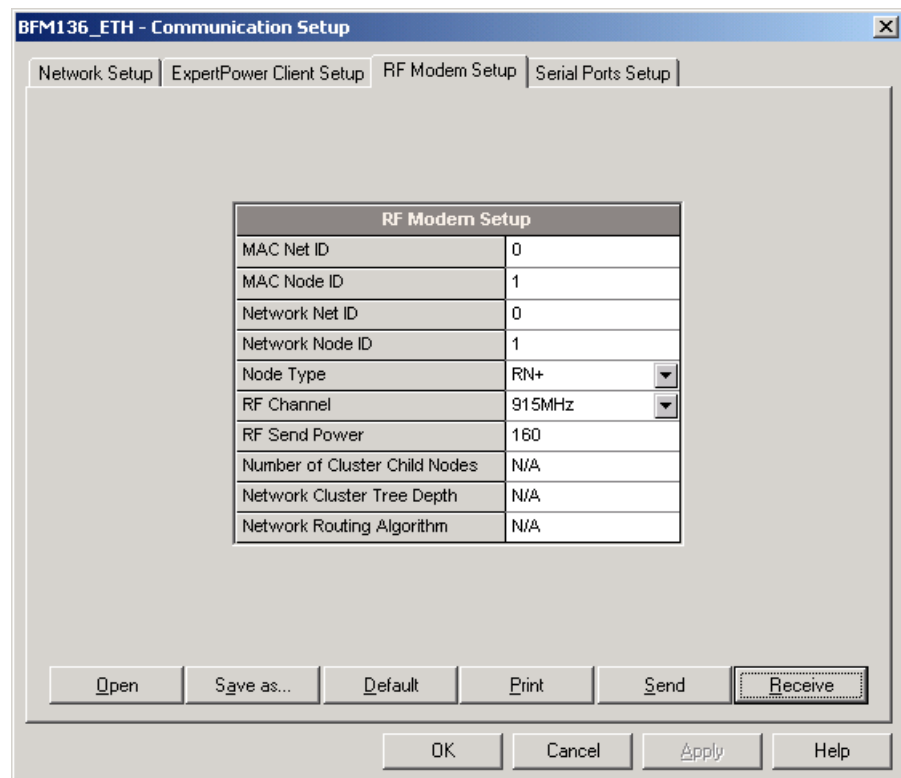
To enter the setup dialog, select the device site from the list box on the PAS toolbar, select Communications Setup from the Meter Setup menu, and then click the Network Setup tab.

To change the Ethernet settings in your device, select desired parameters, and then click Send. For the available options, see [Local Network Settings](#) in Chapter 3.



### Configuring Wireless RF Connections

To enter the Setup dialog, select the site from the list box on the PAS toolbar, select Communications Setup from the Meter Setup menu, and then click on the RF Modem Setup tab.



The following table lists available RF modem options.

Label	Options	Default	Description
MAC Net ID	0-255	0	MAC layer network ID
MAC Node ID	1-247	1	MAC layer node ID
Network Net ID	0-255	0	Network cluster ID
Network Node ID	1-247	1	Network layer node ID
Node Type	RN+, RN-, RFD	RN+	Node router type
RF Channel	907 MHz, 910 MHz, 912 MHz, 915 MHz, 917 MHz, 920 MHz, 922 MHz	915 MHz	RF channel frequency
RF Power	0-255	255	RF send power

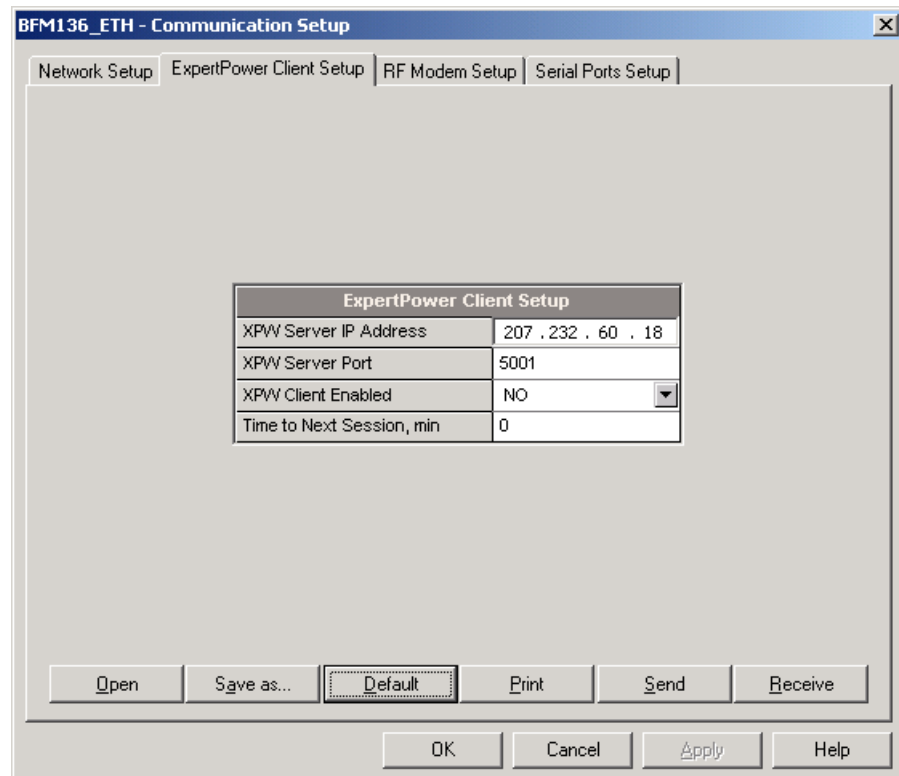
## NOTES:

1. Set the RF channel frequency and the MAC Network ID the same as you selected in the ETC2002 network router.
2. Set the Network Layer Net ID the same as the MAC Network ID.

### Configuring eXpertPower Client

The BFM036/136 has an embedded eXpertPower™ client that provides communications with the eXpertPower™ server - the SATEC proprietary Internet services. Connections to the eXpertPower™ server are handled on a periodic basis.

To enter the Setup dialog, select the site from the list box on the PAS toolbar, select Communication Setup from the Meter Setup menu, and then click the ExpertPower Client Setup tab.



The following table lists available options. Refer to your eXpertPower service provider for the correct eXpertPower settings.

<b>Parameter</b>	<b>Options</b>	<b>Default</b>	<b>Description</b>
XPW Server IP Address		207.232.60.18	The IP address of the eXpertPower server
XPW Server Port	0-65535	5001	The TCP service port of the eXpertPower server
XPW Client Enabled	NO, YES	NO	Enables operations of the eXpertPower client
Time to Next Session, min	1-99999		The time remaining to the next connection session

#### NOTES

1. If you do not use the eXpertPower™ service, do not enable the eXpertPower client in your device.
2. Do not change the connection period setting. The eXpertPower server updates it automatically.

## General Meter Setup

This section describes how to configure the BFM036/136 for your particular environment and application using PAS.

### Basic Meter Setup

Before operating your meter, provide the device with basic information about your electrical network.

To enter the setup dialog, select the device site from the list box on the PAS toolbar, and then select General Setup from the Meter Setup menu.

The following table lists available device configuration options.

Parameter	Options	Default	Description
<b>Basic Configuration</b>			
PT Ratio	1.0-6500.0	1.0	The phase potential transformer's primary to secondary ratio
Primary current	1-10000 A	50A	The primary current of the submeter's current transformers; for information only.
Nominal frequency	50, 60 Hz	60Hz	The nominal power frequency
<b>Demand Setup</b>			
Block power demand period	1, 2, 5, 10, 15, 20, 30, 60 min	30	The length of the demand period for power demand calculations
The number of blocks in the sliding window	1-15	1	The number of block demand periods to be averaged for sliding window demands
Volt demand period	0-9000 sec	900 sec	The length of the demand period for volt demand calculations
Ampere demand period	0-9000 sec	900 sec	The length of the demand period for ampere demand calculations

Parameter	Options	Default	Description
<b>Device Options</b>			
Power calculation mode	S=f(P, Q) (using reactive power), Q=f(S, P) (using non-active power)	S=f(P, Q)	The method used for calculating reactive and apparent powers (see "Power Calculation Modes" below)
Energy roll value, kWh	100000.0 kWh 1000000.0 kWh 10000000.0 kWh 100000000.0 kWh	100000000.0	The value at which energy counters roll over to zero
Energy LED pulse rate, Wh/pulse	0.01-100.00	5.40 Wh/pulse (one equivalent disk revolution)	LED pulse constant - the amount of accumulated energy (in secondary readings) giving one pulse via "Wh".
Energy LED Test	Disabled, Wh Pulses, varh Pulses	Disabled	The type of accumulated energy giving pulses via "Wh" LED.
Energy LED Pulse source	SubMeter 1, SubMeter 2, ... SubMeter 40	SubMeter 1	The submeter uses as source of accumulated energy giving pulses via "Wh" LED.
Volts Scale, V	60-600 V	600 V	The maximum voltage scale allowed, in secondary volts. See <a href="#">Data Scales</a> in Appendix E

### Power Calculation Modes

The power calculation mode option allows you to change the method for calculating reactive and apparent powers in presence of high harmonics. The options work as follows:

1. When the reactive power calculation mode is selected, active and reactive powers are measured directly and apparent power is calculated as:

$$S = \sqrt{P^2 + Q^2}$$

This mode is recommended for electrical networks with low harmonic distortion, commonly with THD < 5% for volts, and THD < 10% for currents. In networks with high harmonics, the following method is preferable.

2. When the non-active power calculation mode is selected, active power is measured directly, apparent power is taken as product  $S = V \times I$ , where  $V$  and  $I$  are the RMS volts and amps, and reactive power (called non-active power) is calculated as:

$$N = \sqrt{S^2 - P^2}$$

### Channel Assignments

The Channel Assignments setup allows you to link the device current terminals to submeters so they can monitor them. Additionally, this setup allows you to specify the primary current rating of the current transformers connected to the device terminals. The number of the selected current inputs for a submeter specifies if it will be a single-, two-, or three-phase meter.

**Always select your submeters (both metering and totalization) in a sequence without gaps so that your device does not occupy unnecessary network addresses.**

To enter the setup dialog, select the device site from the list box on the PAS toolbar, select General Setup from the Meter Setup menu, and then click on the Channel Assignments tab.

The screenshot shows the 'BFM136 - General Setup' dialog box with the 'Current Channel Assignments' tab selected. The table below represents the data shown in the screenshot:

SubMeter	Phase L1	Phase L2	Phase L3	CT Primary, A
#1	I1	I2	I3	50
#2	I4	I5	I6	50
#3	I7	I8	I9	50
#4	I10	I11	I12	50
#5	I13	I14	I15	50
#6	I16	I17	I18	50
#7	I19	I20	I21	50
#8	I22	I23	I24	50
#9	I25	I26	I27	50
#10	I28	I29	I30	50
#11	I31	I32	I33	50
#12	I34	I35	I36	50
#13	----	----	----	----
#14	----	----	----	----
#15	----	----	----	----
#16	----	----	----	----

The following table lists available options.

Label	Parameter	Options	Default	Description
<b>SubMeter</b>	Submeter number	#1-#36		The submeter index
<b>Phase L1</b> <b>Phase L2</b> <b>Phase L3</b>	Phase current input terminal number	I1-I36, None	See note <sup>1</sup>	Links a current input terminal to the corresponding submeter's phase voltage input V1, V2 or V3
<b>CT</b>	CT primary current <sup>2</sup>	1-10000 A	50 A	Specifies the primary rating of the submeter current transformers

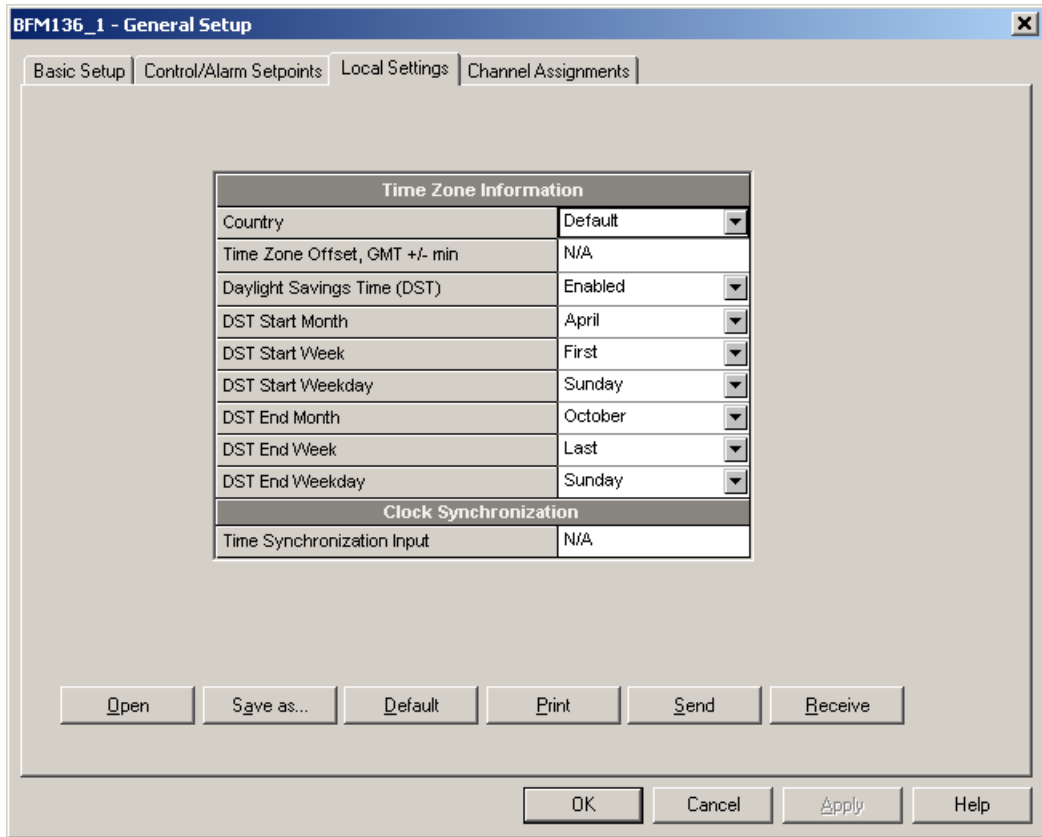
<sup>1</sup> The device is pre-configured for twelve three-phase submeters as shown in the picture.

<sup>2</sup> Specify the CT ratings assuming a ×200% device inputs overrange. The device inputs are preset for 100A current transformers with a 50A primary rating.

## Local Settings

The Local Settings setup allows you to specify your time zone and daylight savings time options.

To configure the time zone options for your device, select the device site from the list box on the PAS toolbar, select General Setup from the Meter Setup menu, and then click on the Local Settings tab.



The available options are described in the following table:

Parameter	Options	Default	Description
Country code	Default, or country name	Default	Defines a currency and calendar settings. The default setting stands for the U.S.A.
Daylight savings time option	Disabled Enabled	Disabled	When DST is disabled, the RTC will operate in standard time only. When enabled, the device will automatically update the time at 2:00 AM at the pre-defined DST switch dates.
DST start month DST start week DST start weekday	Month-week-weekday Week = 1 <sup>st</sup> , 2 <sup>nd</sup> , 3 <sup>rd</sup> , 4 <sup>th</sup> or Last (last week of the month)	First Sunday in April	The date when Daylight Savings Time begins. The DST switch point is specified by the month, week of the month and weekday. By default, DST starts at 2:00 AM on the first Sunday in April of each year.
DST end month DST end week DST end weekday	Month-week-weekday Week = 1 <sup>st</sup> , 2 <sup>nd</sup> , 3 <sup>rd</sup> , 4 <sup>th</sup> or Last (last week of the month)	Last Sunday in October	The date when Daylight Savings Time ends. The DST switch point is specified by the month, week of the month and weekday. By default, DST ends at 2:00 AM on the last Sunday in October of each year.

When the daylight savings time is enabled, the BFM036/136 automatically adjusts the device clock at 02.00 AM when daylight savings time begins/ends. The default daylight savings time change points are set for the U.S.A.

If the daylight savings time option is disabled, you need to manually adjust the device clock for daylight savings time.

### Using Alarm/Control Setpoints

BFM036/136 has an embedded logical controller that runs different actions in response to user-defined internal and external events. Unlike a PLC, the



BFM036/136 uses a simplified programming technique based on setpoints that allows the user to program a required action based on a measured analog value or on a time. The controller provides up to 4 setpoints for each submeter.

This setup allows configuring setpoints for each individual submeter. It can be read and changed via the corresponding submeter's address.

To program the setpoints for a submeter, select General Setup from the Meter Setup menu, and then click on the Control/Alarm Setpoints tab.

Control/Alarm Setpoints						
No.	Trigger parameter	Operate limit	Release limit	Operate delay	Release delay	Action
1	HIGH I1	45.00	40.00	1.0	1.0	NONE
2	LOW I2	40.00	45.00	1.0	1.0	NONE
3	HIGH kW IMP	100.00	90.00	0.0	0.0	NONE
4	HIGH FREQ	52.00	50.00	0.0	0.0	NONE
5	N/A	----	----	----	----	----
6	N/A	----	----	----	----	----
7	N/A	----	----	----	----	----
8	N/A	----	----	----	----	----
9	N/A	----	----	----	----	----
10	N/A	----	----	----	----	----
11	N/A	----	----	----	----	----
12	N/A	----	----	----	----	----
13	N/A	----	----	----	----	----
14	N/A	----	----	----	----	----
15	N/A	----	----	----	----	----
16	N/A	----	----	----	----	----

The following table describes the setpoint options.

Option	Range	Description
Trigger parameter	See Appendix D	The trigger parameter that is used as an argument in the logical expression
Operate limit		The threshold (in primary units) at which the conditional expression would be evaluated to true. Not applicable for time triggers.
Release limit		The threshold (in primary units) at which the conditional expression would be evaluated to false. Defines the hysteresis for analog triggers. Not applicable for digital triggers.
Operate delay	0.1-999.9 sec	The time delay before operation when the operate conditions are fulfilled
Release delay	0.1-999.9 sec	The time delay before release when the release conditions are fulfilled
Action	See Appendix D	The action performed when the setpoint expression is evaluated to true (the setpoint is in operated state)

### Using Numeric Triggers

For numeric (analog) triggers, a setpoint allows you to specify two thresholds for each trigger to provide hysteresis (dead band) for setpoint operations. The operate limit defines the operating threshold, and the second release limit defines the release threshold for the trigger. If you do not want to use

hysteresis for the trigger, set the release limit to the same as the operate limit.

### Using Time Triggers

If you want the setpoint actions to be synchronized with the clock, for example, to provide recording interval data, use the minute time interval trigger that generates periodic events synchronized with the device clock.

### Delaying Setpoint Operations

Two optional delays can be added to each setpoint to extend monitoring a setpoint trigger for a longer time before making a decision on whether the expected event occurred or not. When a delay is specified, the logical controller will change the setpoint status only if all conditions are asserted for a period at least as long as the delay time.

### Using Setpoint Events

When a setpoint status changes, i.e., a setpoint event is either asserted or de-asserted, the following happens in your device:

1. The new setpoint status is logged to the setpoint status register that can be monitored via communications from the user application software in order to give a real-time indication on the expected event.
2. The operated setpoint status is latched to the setpoint alarm register accessible through communications. The register holds the last setpoint alarm status until it is explicitly cleared via communications.

### Recording Setpoint Events

Time-tagged setpoint events can be recorded to the submeter event log if you select it as the setpoint action. The Event recorder logs any setpoint transition event: both when the setpoint is operated, and when it is released.

## Configuring Billing Energy and TOU Registers

The BFM036/136 provides four total/summary energy and four parallel tariff energy and maximum demand registers for each individual submeter. The registers can be linked to any internal energy source or to another submeter.

The meter tariff structure supports four different tariffs using an arbitrary tariff schedule. A total of four types of days and four seasons are supported with up to eight tariff changes per day.

The meter can provide automatic daily profile recording for total and tariff energy and maximum demand registers. The device memory is sufficient to store daily profile data for 120 days.

By default, the first billing register in your meter is linked to the kWh accumulator, and the daily profile recording is enabled for the kWh register. Other billing registers are not operational. To activate the remaining registers or to change the profile for the first billing register:

1. Link the Summary/TOU registers to the respective energy sources, and then configure the options for these registers like whether the only totalization or both total and tariff registers would be used, and whether daily profiling should be enabled for the energy usage and maximum demand registers.
2. Configure the daily tariff schedule for all types of days and seasons using the TOU daily profiles.
3. Configure the season tariff schedule using the TOU calendar.

## Setting up Total and Tariff Registers

To configure the device total (summary) and TOU registers, select Energy/TOU from the Meter Setup menu.

The available options are shown in the following table:

Parameter	Options	Default	Description
<b>Summary/TOU Registers</b>			
TOU	Unchecked Checked	Unchecked	Links tariff registers to the selected energy source
Use Prof	Unchecked Checked	Unchecked	Enables automatic daily profiling for energy usage registers (both total and tariff registers if TOU is enabled)
Dmd Prof	Unchecked Checked	Unchecked	Enables automatic daily profiling for maximum demand registers (both total and tariff registers if TOU is enabled)
Sum Prof	Unchecked Checked	Unchecked	Enables daily profiling for summary registers (total of all tariffs). Automatically set when profiling is enabled.
Units	kWh, kvarh, kVAh	None	The register measurement units. It is set automatically.
<b>Register Source List</b>			
Source Input	None kWh Import kvarh Import kVAh Submeter 1 - Submeter 40 <sup>1</sup>	None	Links an energy source to the target register of all metering submeters, or links all registers of a source submeter to a totalization submeter.
Multiplier	0.001 to 100.000	0.100	The multiplication factor for the energy source.
Target	Reg#1- Reg#3 Submeter 1 - Submeter 40 <sup>1</sup>	None	Defines the target register for the energy source. It is set automatically for target energy registers.

<sup>1</sup> Linking a submeter to another totalization submeter connects all its configured energy registers to the corresponding registers of the target submeter.

### Totalization Submeters

If you wish to automatically totalize energy measured by a number of submeters by using a separate totalization submeter, select a source submeter in the Source Input column on the Register Source List pane (starting with source 5), and then select the desired target totalization submeter in the Target column. Repeat these steps for all source submeters while selecting the same totalization submeter as the target.

Selecting a submeter as a target automatically connects all active energy registers of the source submeters to its energy registers, thus making it a totalization submeter. Note that each totalization submeter takes its own communication address in a sequential order along with the metering submeters (see [Submeter Addressing](#)).

## Configuring the Daily Tariff Schedule

To configure your daily tariff schedule, select Energy/TOU from the Meter Setup menu, and then click on the TOU Daily Profiles tab.

Daily Tariff Profile		
Season	Day Type	
#1	#1	
No.	Tariff Start Time	Tariff No.
1	00:00	#3
2	07:00	#2
3	11:00	#1
4	17:00	#2
5	23:00	#3
6	00:00	#1
7	00:00	#1
8	00:00	#1

The daily profile setup allows you to specify the daily tariff change points with a 15-minute resolution for four tariffs and four seasons.

To configure your daily profiles:

1. Select the desired season and day type.
2. Select the start time for each tariff change point and the corresponding active tariff number.
3. Repeat the setup for all active profiles.

The first tariff change point is fixed at 00:00 hours, and the last tariff change you specified will be in use until 00:00 hours on the next day.

The energy daily profile log will be automatically configured for the number of active tariffs you defined in the BFM036/136 TOU daily profile.

### Configuring the Season Tariff Schedule

To configure your season tariff schedule, select Energy/TOU from the Meter Setup menu, and then click on the TOU Calendar tab.

The TOU calendar allows you to configure any tariff schedule based on any possible utility regulation. The calendar itself has 32 entries that allow you to specify profiles for working days and holidays through all seasons in any order that is convenient for you, based on simple intuitive rules. There are no limitations on how to define your schedule. The BFM036/136 is able to automatically recognize your settings and to select a proper daily tariff schedule for any day within a year.

The following picture gives you an example of a single-season tariff schedule configured for weekends and the designated US holidays.

No.	Season	Day Type	Week of Month	Weekday	Till Weekday	Month	Day	Till Month	Till Day
1	#1	#1	----	Monday	Friday	----	----	----	----
2	#1	#2	----	Saturday	Sunday	----	----	----	----
3	#1	#2	----	----	----	January	1	----	----
4	#1	#2	Last	Monday	----	May	----	----	----
5	#1	#2	----	----	----	July	4	----	----
6	#1	#2	First	Monday	----	September	----	----	----
7	#1	#2	Fourth	Thursday	----	November	----	----	----
8	#1	#2	----	----	----	December	25	----	----
9	----	----	----	----	----	----	----	----	----
10	----	----	----	----	----	----	----	----	----
11	----	----	----	----	----	----	----	----	----
12	----	----	----	----	----	----	----	----	----
13	----	----	----	----	----	----	----	----	----
14	----	----	----	----	----	----	----	----	----
15	----	----	----	----	----	----	----	----	----
16	----	----	----	----	----	----	----	----	----

Buttons: Open, Save as..., Clear, Print, Send, Receive, OK, Cancel, Apply, Help

To configure your season tariff schedule:

1. In the "Season" box, select the season, and in the "Day Type" box, select a day type for this calendar entry.
2. Select the time interval when this daily tariff schedule will be effective based on the start and the end weekdays and, for a multi-season schedule, on the start and the end month for the selected season. It does not matter which order of weekdays or months you selected: the BFM036/136 recognizes the correct order.
3. For exception days such as holidays, select a specific day either by specifying a day and month, or by selecting a month, a week and a weekday within the month.

## Configuring Data Recorders

The BFM036/136 provides a separate Data recorder for each metering submeter. The recorder is triggered via a setpoint periodically for recording interval data (see [Using Alarm/Control Setpoints](#)).

The device memory is factory partitioned to allow recording one data log file per submeter (Data Log #1) with a maximum of 5000 records per file. A data log file is organized as a wrap-around file that needs not to be cleared explicitly though it can be done via PAS (see [Clearing Maximum Demands and Log Files](#)). When a file is filled up, the new records overwrite oldest records, so a file always keeps the 5000 latest records.

The Data recorder is programmable to record up to six data parameters per record. The list of parameters is configured individually for each submeter and can be read and changed via the corresponding submeter's address.

To configure the data log for a submeter:

1. Select Log Setup from the Meter Setup menu.

Data Log Parameters					
No.	Group	Parameter	No.	Group	Parameter
1	SUMMARY REGS	SUM REG1	9	N/A	N/A
2	TOU REG1	TOU REG1 TRF1	10	N/A	N/A
3	TOU REG1	TOU REG1 TRF2	11	N/A	N/A
4	TOU REG1	TOU REG1 TRF3	12	N/A	N/A
5	AVR TOTAL	KW	13	N/A	N/A
6	SUMM SW DMD	SUM REG1 SW DMD	14	N/A	N/A
7	N/A	N/A	15	N/A	N/A
8	N/A	N/A	16	N/A	N/A

2. Configure the list of parameters to be recorded in the data log file. See [Parameters for Data Monitoring and Logging](#) in Appendix C for a list of the available parameters.
3. Add the name for your data log file in the Name box. It will appear in the data log reports.
4. Save your new setup to the device database, and send it to the meter.
5. Configure a setpoint for periodic triggering the Data recorder using the MINUTE INTERVAL trigger (see [Using Alarm/Control Setpoints](#)).

## Remote Device Control

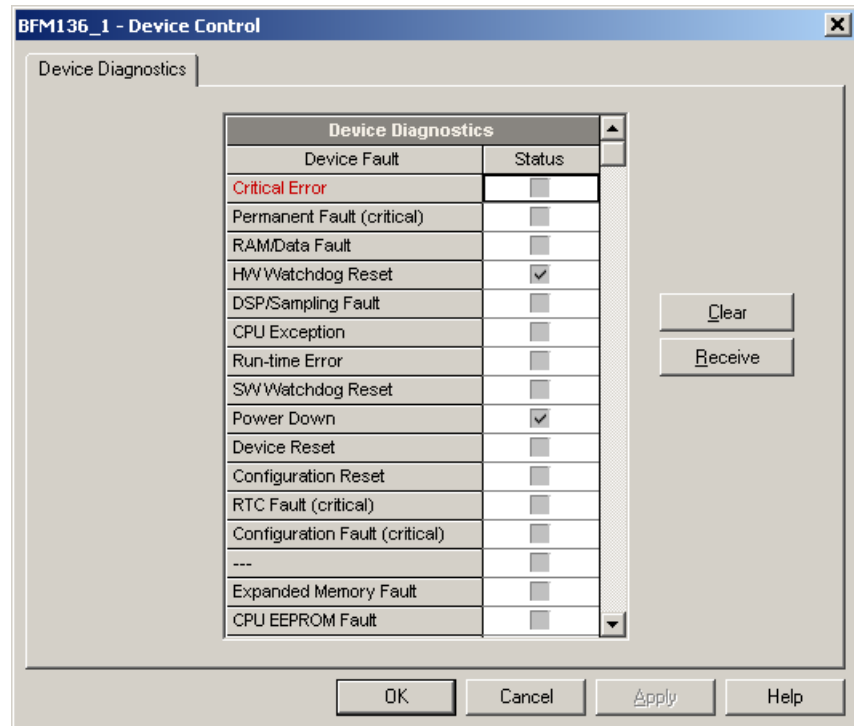
This section describes some online operations on the BFM036/136 you can perform through PAS. To access device control options you should have your device online.

## Viewing and Clearing Device Diagnostics

To view or clear the device diagnostics status, check the On-line button on the PAS toolbar and select Device Control from the Monitor menu.

Refer to [Device Diagnostic Codes](#) in Appendix F for the list of diagnostic codes and their meanings. See [Device Diagnostics](#) in Chapter 2 for more information on the BFM036/136 built-in diagnostics.

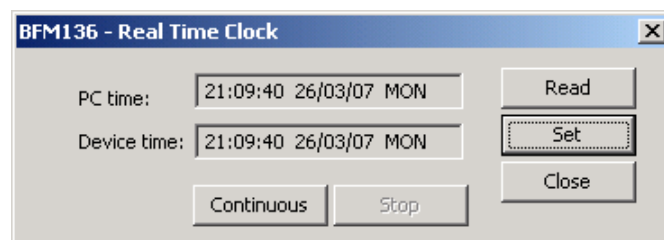
Click on the Clear button to clear the device diagnostics. You must be connected to the BFM036/136 using the device base address to be able to clear the diagnostics status.



## Updating the Clock

To update the RTC clock in your device, select a site with base device address from the list box on the toolbar, check the On-line button on the toolbar, and then select RTC from the Monitor menu.

The RTC dialog box displays the current PC time and the time in your device. To synchronize the device clock with the PC clock, click Set.



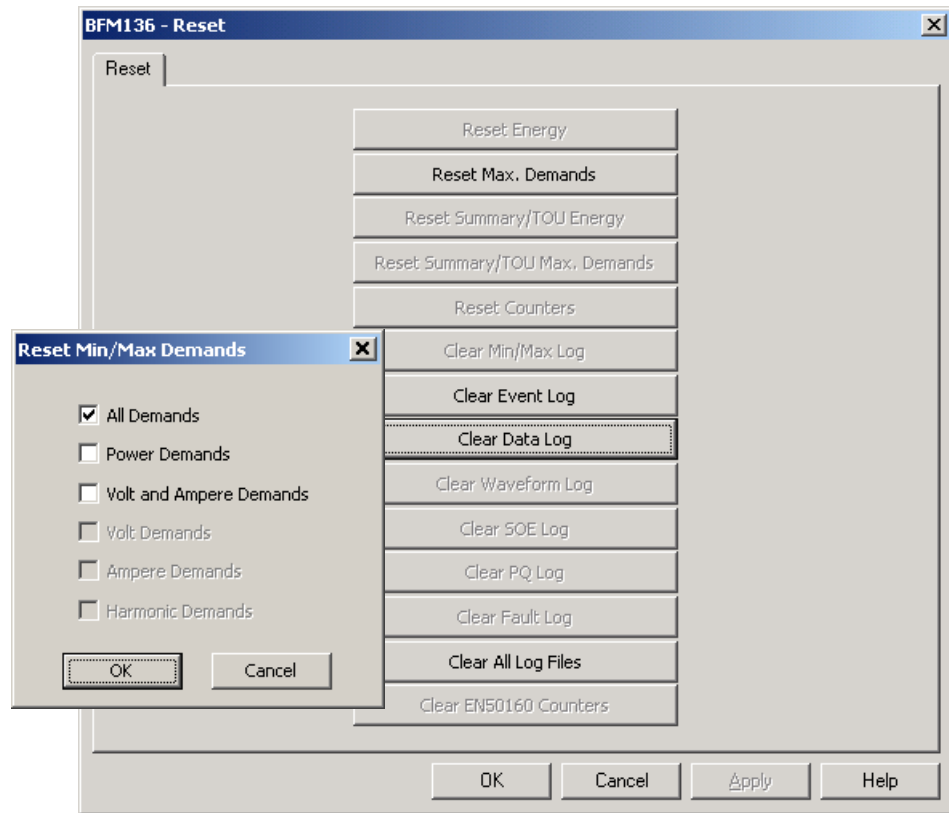
## Clearing Maximum Demands and Log Files

PAS allows you to remotely clear maximum demands and log files individually in each submeter.

To open the dialog box, select a device site from the list box on the toolbar, check the On-line button, and then select Reset from the Monitor menu.

To reset the desired registers or to clear a file:

1. Click on the corresponding button, and then confirm your command.
2. If a target has more than one component, you are allowed to select components to reset.
3. Check the corresponding boxes and click OK.



## Administration

PAS allows you to remotely change the password or network security in your BFM036/136. Use the device base address to access your device.

To change the password, select a device site from the list box on the PAS toolbar, check the On-line button, click Administration from the monitor menu, and then select Change Password.

To change the password, type in a new 8-digit password, repeat the password in the Confirm box, and then click Send.



## Upgrading Device Firmware

Your meter has upgradeable firmware. If you need to upgrade your device, you can download a new firmware file to the meter through PAS.

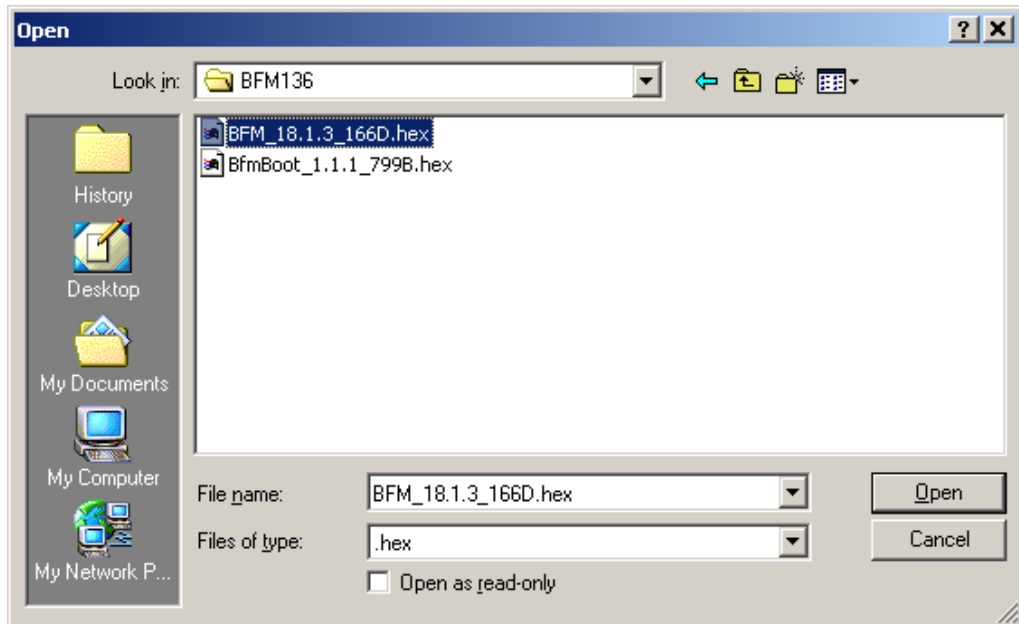


Firmware can be downloaded through any communication port. The meter can be connected to your PC through a serial interface, a dial-up modem, the Internet, or the RF modem.

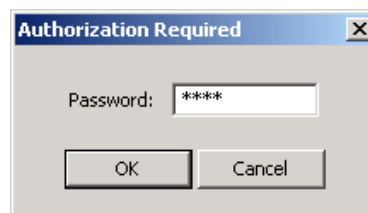
Upgrading is only supported through the Modbus RTU and Modbus/TCP protocols, so your serial port or a dial-up modem port should be put into Modbus RTU mode.

To download a new firmware file to your device:

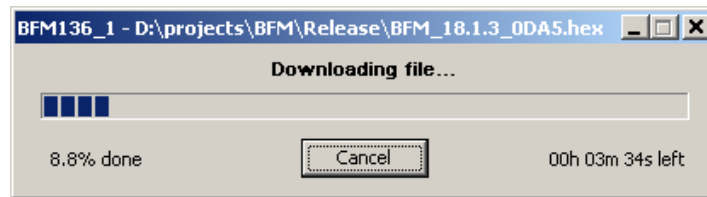
1. Ensure that the communication port you are connected through to the meter operates in Modbus RTU mode (factory default).
2. If the port is configured for a different protocol, put it into Modbus RTU mode either from the front display, or remotely through PAS. If you are connected to the meter through a serial interface, it is recommended to set the port baud rate to 115,200 bps. See “Changing Port Settings” on how to remotely change the protocol and baud rate in your meter.
3. Check the On-line button on the PAS toolbar, select Flash Downloader from the Monitor menu, and then confirm changes.



4. Point to the firmware upgrade file for your BFM036/136, click Open, and then confirm upgrading the device. You would be asked for the password regardless of the password protection setting in your BFM036/136.



5. Type the device password, and click OK.



6. Wait until PAS completes upgrading your device. It would take about 3-4 minutes at 115,200 bps to download the file to the device.

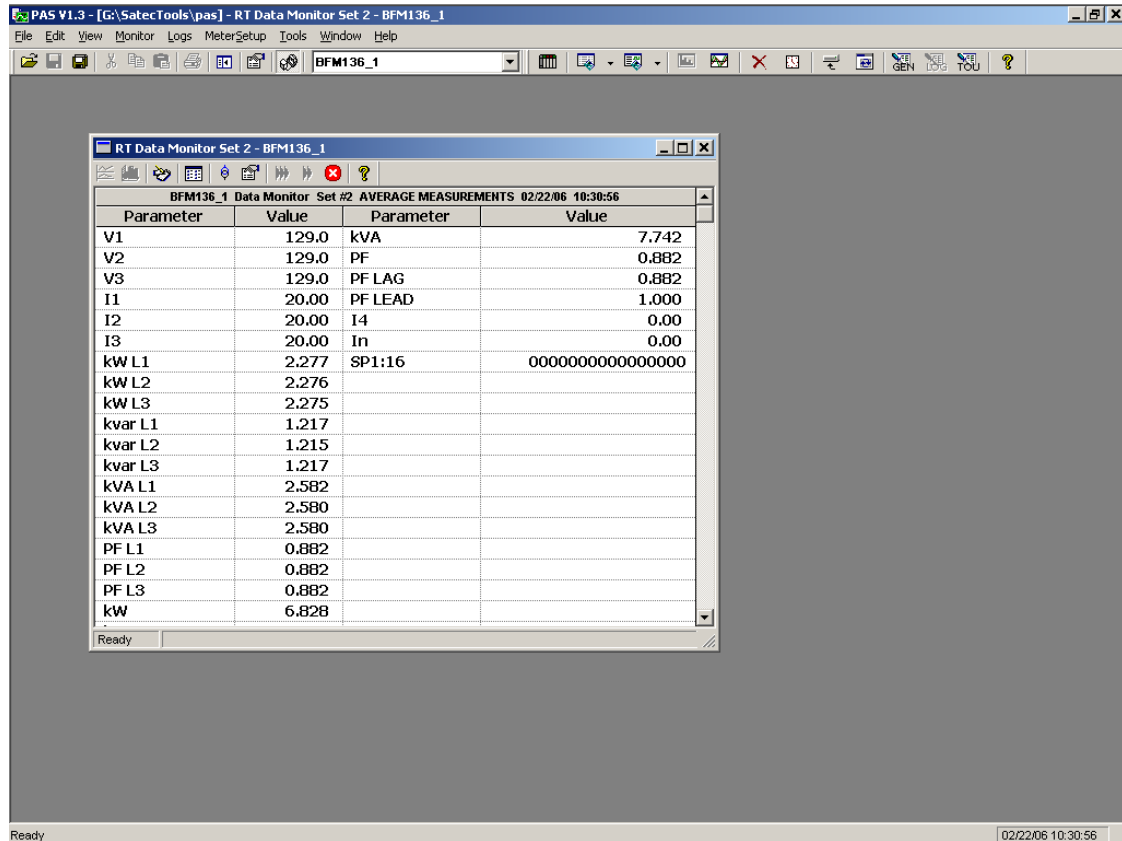


7. After upgrading firmware is completed, the device restarts. If the meter is connected to your PC through the modem, communications can be temporarily lost and you may need to wait until PAS restores a connection with your device.

## Data Monitoring

### Viewing Real-Time Data

Real-time data can be continuously retrieved from the BFM036/136 submeters, updated on the screen at the rate you defined in the Instrument Setup, and recorded to a file. You can view acquired data in a tabular or in a graphical form as a data trend.



For information on the real-time data monitoring and recording options, see the PAS Getting Started Guide.

To get data from all submeters in a single window, click on the Multi-meter View button on the local toolbar.

Any energy and maximum demand registers in the BFM036/136 submeters can be read and recorded to files through the PAS Data Monitor.

### Retrieving Log Files

Using PAS, you can retrieve the event and data log files from the BFM036/136 submeters and save them to files on your PC in the MS Access database format.

Historical data is uploaded on demand any time you need it, or periodically through the Upload Scheduler that retrieves data automatically on a predefined schedule, for example, daily, weekly or monthly. If you do not change the destination database location, new data is added to the same database so you can have long-term data trends and energy profiles in one database regardless of the upload schedule you selected.

For information on uploading files and configuring the Upload Scheduler for the BFM036/136 submeters, see the PAS Getting Started Guide.

### Retrieving the Event Log

The BFM036/136 provides a separate Event log file for each metering submeter. All general device events, like device diagnostics, are recorded to the first Event log file that is accessed via the device base address.

Each Event log file is organized as a wrap-around file that keeps 200 most recent events. The Event log files need not to be cleared explicitly though it can be done via PAS (see [Clearing Maximum Demands and Log Files](#)).

See the PAS Getting Started Guide for information on the event log viewing options.

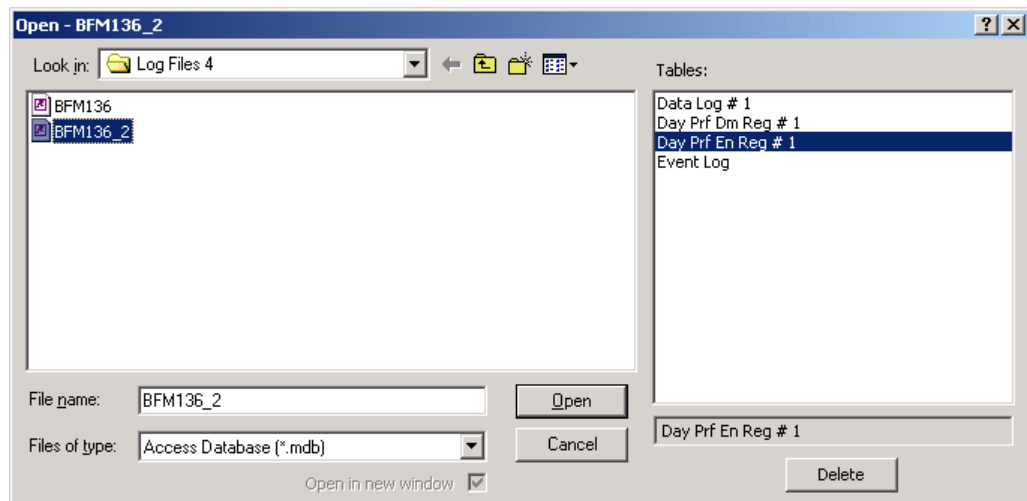
### Retrieving the Data Log and Daily Profile Log

Data log files are recorded and retrieved separately for each submeter. When uploading data log files refer to a regular data log file as Data Log #1, and to the daily profile data file as Data log #16.

### Viewing Daily Profile Data

Energy and maximum demand register's data is recorded to a separate table in the database. A daily profile record always contains the total energy reading of the register at the end of the day, and, if TOU is enabled for the register, readings of tariff registers for all tariffs defined in the daily tariff schedules.

Daily profile tables for energy and maximum demand registers are named as shown in the following picture.



The following picture shows an example of energy profile data readings.

PAS V1.3 - [G:\SatecTools\pas] - DayPrf EnReg1 - BFM136\_2

File Edit View Monitor Logs MeterSetup Tools Window Help

BFM136\_Default

DayPrf EnReg1 - BFM136\_2

BFM136\_2 Profile Log Day Prf En Reg # 1 02/22/06 10:35:59

No.	Date/Time	Event	SUM REG1	SEASON TRF1	SEASON TRF2	SEASON TRF3
1	01/26/06 19:42:58.000		2.2	0.8	0.0	1.4
2	01/26/06 23:59:59.000		25.1	19.0	4.5	1.6
3	01/27/06 23:59:59.000		69.4	19.0	30.6	19.8
4	01/28/06 23:59:59.000		105.7	19.0	52.7	34.0
5	01/29/06 23:59:59.000		174.4	43.7	95.6	35.1
6	01/30/06 23:59:59.000		246.2	68.6	141.4	36.2
7	01/31/06 23:59:59.000		318.0	93.2	187.7	37.1
8	02/01/06 23:59:59.000		386.2	117.7	230.3	38.2
9	02/02/06 23:59:59.000		456.3	143.4	273.7	39.2
10	02/03/06 23:59:59.000		499.8	143.4	299.5	56.9
11	02/04/06 23:59:59.000		544.9	143.4	325.3	76.2
12	02/05/06 23:59:59.000		612.8	167.1	368.2	77.5

D:\My Documents\BFMAzrieli 150206\TOU logs\BFM136\_2.mdb

DayPrf EnReg1 - BFM136\_8

BFM136\_8 Profile Log Day Prf En Reg # 1 02/22/06 10:35:29

No.	Date/Time	Event	SUM REG1	SEASON TRF1	SEASON TRF2	SEASON TRF3
1	01/26/06 19:42:58.000		1.9	0.6	0.1	1.2
2	01/26/06 23:59:59.000		18.7	15.0	1.3	2.4
3	01/27/06 23:59:59.000		75.7	15.0	28.1	32.6
4	01/28/06 23:59:59.000		124.2	15.0	48.9	60.3
5	01/29/06 23:59:59.000		216.4	45.9	101.8	68.7
6	01/30/06 23:59:59.000		312.7	76.6	159.2	76.9
7	01/31/06 23:59:59.000		402.7	107.3	210.1	85.3
8	02/01/06 23:59:59.000		487.6	137.8	256.3	93.5
9	02/02/06 23:59:59.000		619.1	181.7	332.8	104.6
10	02/03/06 23:59:59.000		717.8	181.7	372.2	163.9
11	02/04/06 23:59:59.000		774.7	181.7	401.6	191.4
12	02/05/06 23:59:59.000		863.9	211.4	452.9	199.6

D:\My Documents\BFMAzrieli 150206\TOU logs\BFM136\_8.mdb

Ready 02/22/06 10:36:12

# Appendix A Technical Specifications

## Environmental Conditions

Indoor use only

BFM is intended for operation in environment where normally only non-conductive pollution occurs as defined for pollution degree 2 (UL61010, 3.6.6.2)

Operating Temperature: -20°C to 60°C (-4°F to 140°F)

Storage Temperature: -25°C to 80°C (-13°F to 176°F)

Humidity: 0 to 95% non-condensing

Altitude: 2,000m max

## Input Ratings

Parameter	Value
Fundamental frequency	50/60 Hz
<b>AC Voltage</b>	4 wires, 3 phases+ neutral
Reference Voltage	(115) 88-136 VAC or (230/277) 176-320 VAC
Maximum Line to Neutral voltage	320 V
Maximum Line to Line voltage	544V
Burden per phase	<1.5W
AC Voltage for Measurement and Power supply	Maximal apparent power consumed from power line < 10VA
Isolation	2.5 kV RMS, 60Hz, 1 min Leakage current < 0.005A per circuit Impulse 1.2/50µS 6 kV
Fuse rating	6A, 600V
<b>AC Current</b>	36 current circuits
Maximum measurable current I <sub>max</sub>	100 A
Test current	15 A
Maximum overcurrent for 0.5 cycle of fundamental frequency	3000 A
Burden per phase	< 1 VA
Isolation	2.5 kV RMS, 60Hz, 1 min
<b>LCD Display</b>	
No. Of Digits	2 Rows, 16 digits in each
Non-volatile Memory storage life	20 years
RTC storage upon loss of power	24 Hours minimum 1 Week typical
Push buttons	4
Voltage inputs terminal	10 AWG Max.

## Communication Ports

### COM2 (Optional modules)

#### Serial EIA RS-232 optically isolated port

Connector Type: DB9 female.

Baud Rate: up to 115.2 kbps.

Supported Protocols: Modbus RTU/ASCII.

#### RS-422/RS-485 optically isolated port

Connector Type: removable, captured-wire, 5 terminals.

Wire Size: up to 12 AWG (up to 2.5 mm<sup>2</sup>).

Baud Rate: up to 115.2 kbps.  
Supported Protocols: Modbus RTU/ASCII.

**Ethernet Port**

Transformer-isolated 10/100BaseT Ethernet port.  
Connector Type: RJ45 modular.  
Supported Protocols: Modbus TCP (Port 502).  
Number of simultaneous connections (sockets): 2.

**Dial-up Modem Port**

Transformer-isolated internal 56K modem.  
Connector Type: RJ11.  
Supported Protocols: Modbus RTU/ASCII.

**Real-time Clock**

Accuracy: typical error 1 minute per month @ 25°C

**Standards Compliance**

ANSI C12.20 -1998  
EN50081-2 Generic Emission Standard - Industrial Environment  
EN50082-2 Generic Immunity Standard - Industrial Environment  
EN55022: 1994 Class A  
EN61000-4-2  
ENV50140: 1983  
ENV50204: 1995 (900MHz)  
ENV50141: 1993  
EN61000-4-4:1995  
EN61000-4-8: 1993

### Measurement Specifications

Parameter	Full Scale @ Input Range	Accuracy			Range
		% Reading	% FS	Conditions	
Voltage	$V_L = 230V$	0.3	0.05	184 to 260 V	0 to $V_{max} = 600 V$
Line current	Instrument current transformer CTs $I_L = 100A$	0.5	0.05	1 to 100% FS	0 to CT primary current Starting current: 0.1% FS
Active power	$2 \times V_{max} \times I_L / 1000$ , kW	1	0.02	$ PF  \geq 0.5$ <sup>1</sup>	-120.000 to 120.000 kW
Reactive power	$2 \times V_{max} \times I_L / 1000$ , kvar	1	0.02	$ PF  \leq 0.9$ <sup>1</sup>	-120.000 to 120.000 kvar
Apparent power	$2 \times V_{max} \times I_L / 1000$ , kVA	1	0.02	$ PF  \geq 0.5$ <sup>1</sup>	0 to 120.000 kVA
Power factor	1.0	-	1.0	$ PF  \geq 0.5, I \geq 2\% FSI$	-0.999 to +1.000
Frequency		0.02	-	<b>50 Hz:</b> 39.00 to 65.00 Hz <b>60 Hz:</b> 45.00 to 70.00 Hz	39 Hz up to 70 Hz
Active energy import		Class 1.0 under conditions as per IEC 62053-21:2003			0 to 99,999,999.9 kWh
Reactive energy import/export		Class 1.0 under conditions as per IEC 62053-21:2003, $ PF  \leq 0.9$			0 to 99,999,999.9 Mvarh
Apparent energy		Class 1.0 under conditions as per IEC 62053-21:2003			0 to 99,999,999.9 MVAh

<sup>1</sup> @ 80% to 115% of voltage FS and 1% to 100% of current FS

FSV - voltage full scale

FSI - current full scale

#### Notes

- Accuracy is expressed as  $\pm$  (percentage of reading + percentage of full scale)  $\pm 1$  digit. This does not include inaccuracies introduced by the user's potential and current transformers. Accuracy calculated at 1-second average.
- Specifications assume: voltage and current waveforms with THD  $\leq 5\%$  for kvar, kVA and PF; reference operating temperature: 20°C - 26°C.
- Measurement error is typically less than the maximum error indicated here.



## Appendix B CT Connection Template

Use the following table to memorize your input assignments and wiring connections for sub-consumers.

	Sub-consumer	Input# <sup>1</sup>	Wire Color	Cable#	Group# <sup>2</sup>	CT# <sup>3</sup>	Phase
1							
2							
3							
4							
5							
6							
7							
8							
9							
10							
11							
12							
13							
14							
15							
16							
17							
18							
19							
20							
21							
22							
23							
24							
25							
26							
27							
28							
29							
30							
31							
32							
33							
34							
35							
36							

- <sup>1</sup> #1 through #36
- <sup>2</sup> For 9-CTs card only.
- <sup>3</sup> For 9-CTs and 3-CTs cards

## Appendix C Parameters for Data Monitoring and Logging

The following table lists parameters measured by the meter that are available for data logging and monitoring through communications. The left column shows data abbreviations used in PAS. Parameter groups are highlighted in bold.

<b>Designation</b>	<b>Description</b>
NONE	None (stub, read as zero)
<b>RT PHASE</b>	<b>1-Cycle Phase Values</b>
V1	V1
V2	V2
V3	V3
I1	I1 Current
I2	I2 Current
I3	I3 Current
kW L1	kW L1
kW L2	kW L2
kW L3	kW L3
kvar L1	kvar L1
kvar L2	kvar L2
kvar L3	kvar L3
kVA L1	kVA L1
kVA L2	kVA L2
kVA L3	kVA L3
PF L1	Power factor L1
PF L2	Power factor L2
PF L3	Power factor L3
V12	V12 Voltage
V23	V23 Voltage
V31	V31 Voltage
<b>RT TOTAL</b>	<b>1-Cycle Total Values</b>
kW	Total kW
kvar	Total kvar
kVA	Total kVA
PF	Total PF
PF LAG	Total PF lag
PF LEAD	Total PF lead
kW IMP	Total kW import
kW EXP	Total kW export
kvar IMP	Total kvar import
kvar EXP	Total kvar export
<b>RT AUX</b>	<b>1-Cycle Auxiliary Values</b>
In	In (neutral) Current
FREQ	Frequency
<b>AVR PHASE</b>	<b>1-Second Phase Values <sup>1</sup></b>
V1	V1 Voltage
V2	V2 Voltage
V3	V3 Voltage
I1	I1 Current
I2	I2 Current
I3	I3 Current
kW L1	kW L1
kW L2	kW L2
kW L3	kW L3
kvar L1	kvar L1
kvar L2	kvar L2
kvar L3	kvar L3
kVA L1	kVA L1
kVA L2	kVA L2
kVA L3	kVA L3

Appendix C Parameters for Data Monitoring and Logging

Designation	Description
PF L1	Power factor L1
PF L2	Power factor L2
PF L3	Power factor L3
V12	V12 Voltage
V23	V23 Voltage
V31	V31 Voltage
<b>AVR TOTAL</b>	<b>1-Second Total Values <sup>1</sup></b>
kW	Total kW
kvar	Total kvar
kVA	Total kVA
PF	Total PF
PF LAG	Total PF lag
PF LEAD	Total PF lead
kW IMP	Total kW import
kW EXP	Total kW export
kvar IMP	Total kvar import
kvar EXP	Total kvar export
<b>AVR AUX</b>	<b>1-Second Auxiliary Values <sup>1</sup></b>
In	In (neutral) Current
FREQ	Frequency
<b>DEMANDS</b>	<b>Present Demands <sup>1</sup></b>
V1 DMD	V1 Volt demand
V2 DMD	V2 Volt demand
V3 DMD	V3 Volt demand
I1 DMD	I1 Ampere demand
I2 DMD	I2 Ampere demand
I3 DMD	I3 Ampere demand
kW IMP SD	kW import sliding window demand
kvar IMP SD	kvar import sliding window demand
kVA SD	kVA sliding window demand
kW IMP ACC DMD	kW import accumulated demand
kvar IMP ACC DMD	kvar import accumulated demand
kVA ACC DMD	kVA accumulated demand
kW IMP PRD DMD	kW import predicted sliding window demand
kvar IMP PRD DMD	kvar import predicted sliding window demand
kVA PRD DMD	kVA predicted sliding window demand
<b>SUMM ACC DMD</b>	<b>Summary (TOU Total) Accumulated Demands</b>
SUM REG1 ACC DMD	Summary register #1 demand
SUM REG2 ACC DMD	Summary register #2 demand
SUM REG3 ACC DMD	Summary register #3 demand
SUM REG4 ACC DMD	Summary register #4 demand
<b>SUMM SW DMD</b>	<b>Summary (TOU Total) Sliding Demands <sup>1</sup></b>
SUM REG1 SW DMD	Summary register #1 demand
SUM REG2 SW DMD	Summary register #2 demand
SUM REG3 SW DMD	Summary register #3 demand
SUM REG4 SW DMD	Summary register #4 demand
<b>ENERGY</b>	<b>Total Energy <sup>1</sup></b>
kWh IMPORT	kWh import
kvarh IMPORT	kvarh import
kVAh TOTAL	kVAh total
<b>SUMMARY REGS</b>	<b>Summary (TOU Total) Energy Registers <sup>1</sup></b>
SUM REG1	Summary energy register #1
SUM REG2	Summary energy register #2
SUM REG3	Summary energy register #3
SUM REG4	Summary energy register #4
<b>MAX DMD</b>	<b>Maximum Demands</b>
V1 DMD MAX	V1 Maximum volt demand
V2 DMD MAX	V2 Maximum volt demand
V3 DMD MAX	V3 Maximum volt demand
I1 DMD MAX	I1 Maximum ampere demand
I2 DMD MAX	I2 Maximum ampere demand
I3 DMD MAX	I3 Maximum ampere demand
kW IMP SD MAX	Maximum kW import sliding window demand
kW EXP SD MAX	Maximum kvar import sliding window demand

Designation	Description
kVA SD MAX	Maximum kVA sliding window demand
<b>MAX SUMMARY DMD</b>	<b>Maximum Summary (TOU Total) Demands</b>
SUM REG1 DMD MAX	Summary register #1 maximum demand
SUM REG2 DMD MAX	Summary register #2 maximum demand
SUM REG3 DMD MAX	Summary register #3 maximum demand
SUM REG4 DMD MAX	Summary register #4 maximum demand
<b>TOU PRMS</b>	<b>TOU Parameters</b>
ACTIVE TARIFF	Active TOU tariff
ACTIVE PROFILE	Active TOU profile
<b>TOU REG1</b>	<b>TOU Energy Register #1</b> <sup>1</sup>
TOU REG1 TRF1	Tariff #1 register
TOU REG1 TRF2	Tariff #2 register
TOU REG1 TRF3	Tariff #3 register
TOU REG1 TRF4	Tariff #4 register
<b>TOU REG2</b>	<b>TOU Energy Register #2</b> <sup>1</sup>
TOU REG2 TRF1	Tariff #1 register
TOU REG2 TRF2	Tariff #2 register
TOU REG2 TRF3	Tariff #3 register
TOU REG2 TRF4	Tariff #4 register
<b>TOU REG3</b>	<b>TOU Energy Register #3</b> <sup>1</sup>
TOU REG3 TRF1	Tariff #1 register
TOU REG3 TRF2	Tariff #2 register
TOU REG3 TRF3	Tariff #3 register
TOU REG3 TRF4	Tariff #4 register
<b>TOU REG4</b>	<b>TOU Energy Register #4</b> <sup>1</sup>
TOU REG4 TRF1	Tariff #1 register
TOU REG4 TRF2	Tariff #2 register
TOU REG4 TRF3	Tariff #3 register
TOU REG4 TRF4	Tariff #4 register
<b>TOU MAX DMD REG1</b>	<b>TOU Maximum Demand Register #1</b> <sup>1</sup>
DMD1 TRF1 MAX	Tariff #1 register
DMD1 TRF2 MAX	Tariff #2 register
DMD1 TRF3 MAX	Tariff #3 register
DMD1 TRF4 MAX	Tariff #4 register
<b>TOU MAX DMD REG2</b>	<b>TOU Maximum Demand Register #2</b> <sup>1</sup>
DMD2 TRF1 MAX	Tariff #1 register
DMD2 TRF2 MAX	Tariff #2 register
DMD2 TRF3 MAX	Tariff #3 register
DMD2 TRF4 MAX	Tariff #4 register
<b>TOU MAX DMD REG3</b>	<b>TOU Maximum Demand Register #3</b> <sup>1</sup>
DMD3 TRF1 MAX	Tariff #1 register
DMD3 TRF2 MAX	Tariff #2 register
DMD3 TRF3 MAX	Tariff #3 register
DMD3 TRF4 MAX	Tariff #4 register
<b>TOU MAX DMD REG4</b>	<b>TOU Maximum Demand Register #4</b> <sup>1</sup>
DMD4 TRF1 MAX	Tariff #1 register
DMD4 TRF2 MAX	Tariff #2 register
DMD4 TRF3 MAX	Tariff #3 register
DMD4 TRF4 MAX	Tariff #4 register

<sup>1</sup> Available for data logging.

## Appendix D Setpoint Triggers and Actions

### Setpoint Triggers

Designation	Description
NONE	None (condition is not active)
MINUTE INTERVAL	Minute intervals (10, 15, 30, 60 min) synchronized with the clock
HIGH V1	High V1 voltage
HIGH V2	High V2 voltage
HIGH V3	High V3 voltage
LOW V1	Low V1 voltage
LOW V2	Low V2 voltage
LOW V3	Low V3 voltage
HIGH V12	High V12 voltage
HIGH V23	High V23 voltage
HIGH V31	High V31 voltage
LOW V12	Low V12 voltage
LOW V23	Low V23 voltage
LOW V31	Low V31 voltage
HIGH I1	High I1 current
HIGH I2	High I2 current
HIGH I3	High I3 current
LOW I1	Low I1 current
LOW I2	Low I2 current
LOW I3	Low I3 current
HIGH FREQ	High frequency
LOW FREQ	Low frequency
HIGH KW IMP BD	High kW import
HIGH KVA	High kVA

### Setpoint Actions

Designation	Description
NONE	None (no action)
EVENT LOG	Log to Event Log
DATA LOG #1	Log to Data Log file #1

## Appendix E Data Scales

The maximum values for volts, amps and power in the BFM036/136 setup and in communications are limited by the voltage and current scale settings. See [Basic Meter Setup](#) in Chapter 4 on how to change the voltage scale in your meter.

The following table defines the meter data scales.

Scale	Range	Notes
Maximum voltage (V max)	Voltage scale $\times$ PT Ratio, V	The default voltage scale is 600V
Maximum current (I max)	CT Primary current $\times$ 2, A	The default CT primary current is 50A
Maximum power <sup>1</sup>	V max $\times$ I max $\times$ 2, W	

<sup>1</sup> Maximum power is rounded to whole kilowatts. With PT=1.0, it is limited to 9,999,000 W.

## Appendix F Device Diagnostic Codes

Diagnostic Code	Startup Display Message	Description	Reason
2	RAM/Data Error	Memory/Data error	Hardware failure
3	WDT Reset	Hardware watchdog reset	Hardware failure
4	Sampling Fault	Sampling fault	Hardware failure
5	CPU Exception	CPU exception	Hardware failure
6	Run-Time Error	Run-time software error	Hardware failure
7	Software Exception	Software watchdog timeout	Hardware failure
8	Power Up	Power Down/Up	Loss of power. Normal power-up sequence
9	External Reset	Warm restart/Device reset	External restart via communications or by firmware upgrade
10		Configuration reset	Corrupted setup data has been replaced with the default configuration
11		RTC fault	The clock time has been lost
14		Expanded memory/Data flash fault	Hardware failure

See [Device Diagnostics](#) in Chapter 2 for more information on the BFM136 built-in diagnostics.