



SCREEN RECORDER

KD8 TYPE



USER'S MANUAL

CONTENTS

1.	INTRODUCTION.....	4
1.1	Recorder applications	4
1.2	Recorder features	4
2.	GENERAL INFORMATION.....	5
2.1	Warning and information signs	5
2.2	Safety of service	5
2.2.1	Remarks concerning the recorder installation.....	5
2.2.2	Precautions in the scope of ESD protection.....	6
3.	RECORDER PREPARATION TO WORK.....	7
3.1	Unpacking	7
3.2	Installation in a panel	8
3.3	Operating conditions of the recorder.....	8
4.	RECORDER CONSTRUCTION.....	9
4.1	LCD screen with touch panel	9
4.2	CompactFlash memory card, USB interface, LED diode.....	10
4.3	Terminal plate	11
4.3.1	Connection of analog signals.....	12
4.3.1.1	Programmable measuring inputs AI 1..6	12
4.3.1.2	Alarms AL 1...12 and binary inputs BI 1..8	13
4.3.1.3	Interfaces RS485 Modbus Slave).....	13
4.3.2	Recorder supply (a.c. or d.c.)	14
5.	GRAPHICAL SIGNS ON THE RECORDER SCREEN	14
5.1	Status bar	14
5.2	Measuring views.....	14
5.3	Service menu	15
5.4	Information messages.	15
5.5	Dialogues.....	16
6.	STARTING THE RECORDER.....	16
6.1	Context menu	17
6.2	Entry into the recorder parameter configuration , “KD8 control panel “ windows	19
7.	CONFIGURING THE RECORDER.....	20
7.1	General settings	20
7.2	Modbus Slave configuration.....	21
7.3	KD8 security.....	22
7.4	System information	23
7.5	CF Card.....	24
7.6	Configuration, visualization and archiving of the channel group.....	24
7.7	Analog and binary inputs	26
7.7.1	Programming analog inputs AL1...AL16	26
7.7.2	Alarm (A1 i A2) in analog input configuration.....	31
7.7.3	Binary input BI1..BI8 configuration	35
7.7.4	Common parameters for binary inputs	36
7.8	Programming of measuring groups	36
7.8.1	Programming of group parameters.....	36
7.8.2	Digital view of the channel group.....	39
7.8.3	Linear chart of the channel group.....	40
7.8.4	View of the channel group in the bargraph form.....	42
7.8.5	Analog view of the channel group.....	43
7.8.6	Statistic view of the channel group.....	44
7.8.7	Enabling/disabling the automatic screen switching.....	45
7.9	Zoom scale function of the signal (measuring magnifier).....	46
7.10	Selection of the data file format (digital signature).....	47
7.11	Edition of the user’s name and access password for settings.....	48

7.12	Event logs.....	48
7.12.1	Review and service of event logs.....	49
7.12.2	Programming of event logs.....	50
7.13	Edition of user's messages.....	51
7.14	Exit from the recorder configuration.....	53
8.	SELECTED ELEMENTS OF THE RECORDER CURRENT SERVICE.....	54
8.1	CompactFlash memory card	54
8.1.1	Information about the CF memory card.....	54
8.1.2	Formatting the CF card.....	54
8.1.3	Data storage on the CF card (card storage capacity).....	55
8.1.4	Visualization of the CF card state on the screen	57
8.1.5	Review and erasing of files from the CF card.....	57
8.1.6	Removal/replacement of the CF card, storage of archive data.....	58
8.2	Review of archived data	59
8.3	Calibration of the touch screen	60
8.4	Updating of the recorder software	61
8.5	Service of data stored on the CF card, visualization	62
9.	PROGRAMS ON PC.....	63
9.1	KD Connect program.....	63
9.1.1	Installation of drivers for the KD8 recorder	63
9.1.2	Installation of the KD Connect program	64
9.1.3	Program service.....	65
9.2	KD8 Setup program.....	69
9.2.1	Installation.....	69
9.2.2	Program service.....	69
9.3	KD Check program	71
9.4	KD Archive program.....	72
10.	TECHNICAL DATA	73
11.	ORDER CODES.....	76
12.	MAINTENANCE AND GUARANTEE.....	77

1. INTRODUCTION

1.1 RECORDER APPLICATIONS

The KD8 screen recorder is applied as a data acquisition station in measuring and control systems. It finds application to measure, visualize and supervise technical process parameters in various industrial branches, e.g. pharmacy, food, chemical and papermaking industries.

It can be also used as an autonomous measuring and recording device.

The KD8 screen recorder is adapted to measure voltage, current, temperature, resistance changes and other quantities converted into a signal or electrical parameter. All processes suitable for a measuring system can be realized in this recorder: measurement of input signals and their conversion, visualization and archiving of data, signalling and communication with the environment.

Converted measuring data are stored in the internal memory and on the CompacFlash card.

1.2. RECORDER FEATURES

- LCD TFT 5.7” colour screen, 320 x 240 pixels, with a touch panel for the recorder service,
- Exchangeable CompactFlash external memory card with capacity from 16 MB up to 4 GB,
- Communication interfaces: USB 1.1 Device, RS-485 Modbus Slave,
- Measuring inputs for the direct connection of thermocouples, voltage, current and resistance,
- Alarms, binary inputs,
- Operator messages,
- Digital signature for archived data, stored in text or binary format,
- Linearization of sensor characteristics,
- Programmable current, voltage and resistance inputs,
- Copying of parameter setting between channels,
- Programming of recorder parameters,
- Programming of screens and choice of screen configurations,
- Storage of data in the internal 6 MB buffer with data support (for before damage and after damage states)
- Determination of the set of data for the current exposition on the screen,
- Choice of the time zone, automatic change of summer/winter time.

Note: The updating of the KD8 recorder software is accessible on the page:
<http://www.lumel.com.pl>

2. GENERAL INFORMATION

2.1 Warning and information signs

One or more of presented symbols can be used in the recorder.



Caution: one must pay attention to the description in the recorder user's manual.



Terminal of the protection lead



Earth terminal



Protection of sensitive electrostatic systems (ESD)

2.2 Safety of service

The KD8 recorder fulfils requirements related to safety of electrical measuring instruments for automation, acc. to EN 61010-1 standard and requirements concerning the resistance against interference occurring in industrial environment acc. to EN 61000-6-2 and EN 61000-6-4 standards.

The connection of supply, communication interfaces and measuring signals, and the use of equipment inconsistent with the description included in the present user's manual and standards as above can cause serious weakening of the recorder protection against interference.

2.2.1 Remarks concerning the recorder installation

Various sources of interference occurring in practice interact with the recorder in a continuous or impulse way from the supply network side (as the result of the action of other devices) and also overlap on the measured signal or auxiliary circuits of the recorder.

In particular, strong impulse interference is dangerous for the operation of devices since they can cause sporadic erroneous measurement results or accidental operations of alarms, despite of the use of suitable filters in the recorder. The level of this interference should be reduced to a value lower than the resistance threshold of the recorder, first of all through a suitable installation of the recorder in the object.

In this scope, it is recommended to observe following recommendations:

- Do not supply recorders from networks near devices generating high impulse interference in the supply network and do not use common grounding circuits with them,
- Use network filters for the group of recorders servicing the same object,
- Use metallic shields in the shape of tubes or braids to lead supplying wires (phase, zero), in which one can also lead the earth conductor and eventually network wires supplying contacts of alarm relays of the given recorder,

- Lead individually connections of binary input circuits in shields as above, by means of twisted wires,
- Lead individually connections of communication interface circuits in shields as above and by means of twisted wires,
- Wires leading measuring signals for each measuring recorder channel should be twisted in pairs, and for resistance sensors in 3-wire connection, twisted of wires of the same length, cross-section and resistance, and led in shields as above. Wires leading measuring signals to the same recorder can be led in the same shield (if it is possible),
- All shields should be earthed unilaterally near the recorder,
- One must avoid a common earth conductor with other devices,
- Apply the general principle, that wires (group of wires) leading different signals should be led in the longest possible distance between them and crossings of such groups of wires made at a 90° angle,
- Set on the supply cable (near the recorder) a ferrite filter ZCAT 2035-0930A (TDK) being in the recorder accessory set.
- One must remember that in the building installation a switch or a circuit-breaker should be installed near the recorder, easy accessible by the operator and suitably marked.
- Before removing the recorder housing, one must switch the supply off and disconnect measuring circuits.
- All operations concerning installation, commissioning as well as maintenance must be carried out by qualified skilled personnel, and national regulations for the prevention of accidents must be observed.
- Protections ensuring the recorder safety may be less effective in case of an exploitation contrary with producer's indications and principles of a good engineering practice.

2.2.2. Precautions in the scope of ESD protection



Semiconductor elements or packages used in the recorder design and marked with the sign as above, can become damaged in result of electrostatic discharges (ESD).

In order to prevent this, one must observe following recommendations during service works.

- Disassemble instruments only in the area protected against electrostatic discharges,
- Use conductive materials to dissipate electrostatic charges in the working area,
- Use only anti electrostatic packings to store electronic elements and packages,
- Do not touch elements and packages with hands,
- Do not keep materials susceptible to generate electrostatic charges in the working area.



CAUTION: Repairs and modifications in the recorder equipment should be carried out by authorized service workshops or with the manufacturer.

3. RECORDER PREPARATION TO WORK

The recorder with accessories is delivered in packing fulfilling requirements of environment protection regulations.

The recorder in the packing can be transported and stored in the temperature: -20 ...+60°C (-4 ...140°F).

3.1 Unpacking

- **Taking the KD8 recorder out from the shipping packing**

The data plate with the version code, factory number and supply parameters are placed on the recorder housing. Before unpacking, check the conformity of the recorder version with the order.



- **Take recorder accessories out from the packing.**

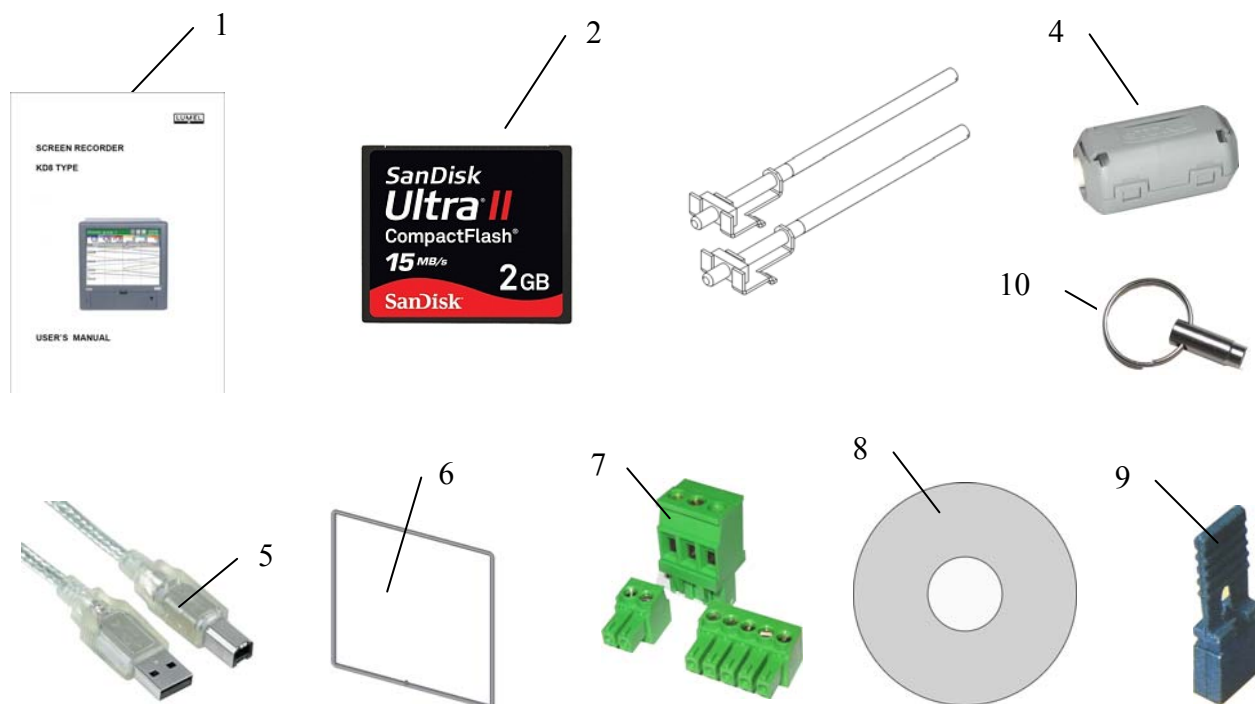

- | | |
|--|-------|
| 1. User's manual (printed version or on a CD disk) | 1 pc |
| 2. 2 GB CF memory card | 1 pc |
| 3. Mounting brackets | 4 pcs |
| 4. Ferrite core | 1 pc |
| 5. USB cable 1.8m (shielded) | 1 pc |
| 6. Seal (KD8 housing-panel) | 1 pc |
| 7. Set of plugs ¹⁾ | 1 set |

- | | |
|---------------------------|------------|
| 8. CDR disk ²⁾ | 1 pc |
| 9. Current test links | 3 or 6 pcs |
| 10. Keys | 2 pcs |
| 11. Guarantee card | 1 pc |

- 1) The set is accommodated to the ordered recorder version
- 2) Following documents are recorded on the CDR: user's manual of the KD8 recorder, **KD CONNECT** program for the communication with KD8 through the USB interface, **KD CHECK** program to check the digital signature in archive files, USB drivers for the KD8 recorder and, according to the order version, **KD8 SETUP** and **KD ARCHIVE** programs with user's manuals to service these programs.

3.2 Installation in a panel

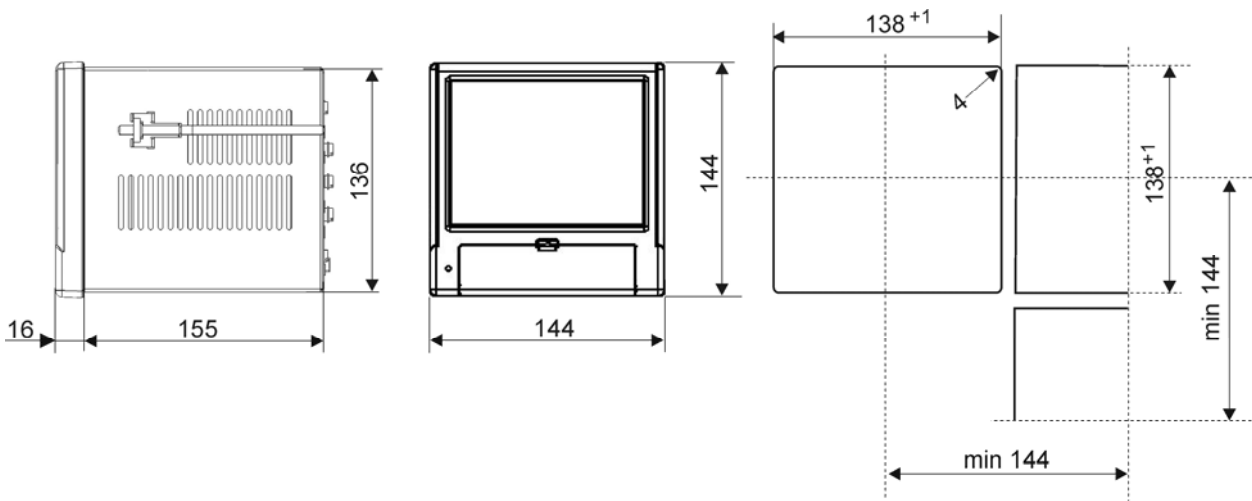

Put the seal from standard accessories on the housing (see section 3.1.). After mounting the recorder into the panel, the seal protects the part behind the panel against the influence of risks appearing from the frontal part of the panel, resulting from the IP65 protection degree.

The recorder is fixed to the panel by means of four screwed mounting brackets from the recorder accessories (see section 3.1.).

Basic fixing and panel cut-out dimensions are presented above.

3.3. Operating conditions of the recorder

The recorder can work at ambient temperature: 0...+50°C (32 ...122°F) and max.75% of relative air humidity without condensation.

4. RECORDER CONSTRUCTION

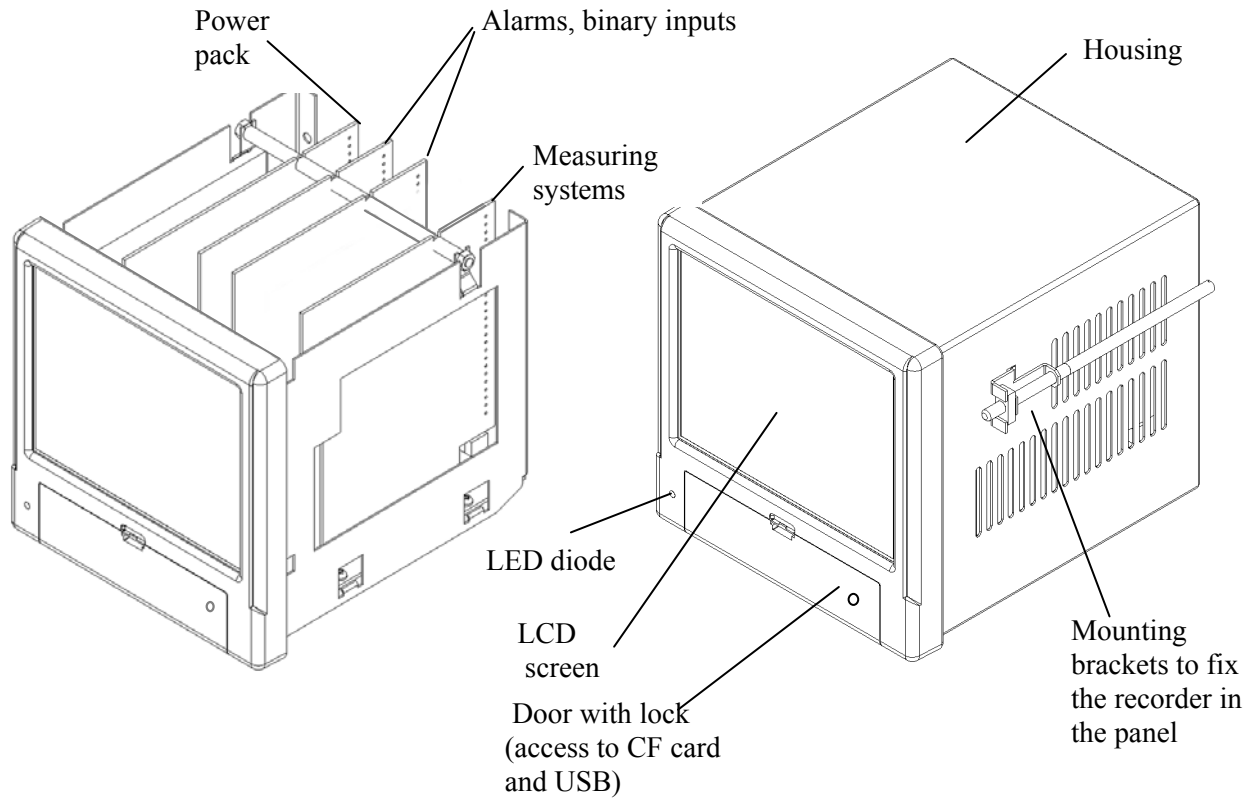

4.1. LCD screen with touch screen

For the visualization of measuring data and the configuration of recorder parameters, an LCD TFT 5,7" graphical screen integrated with the touch screen is applied.

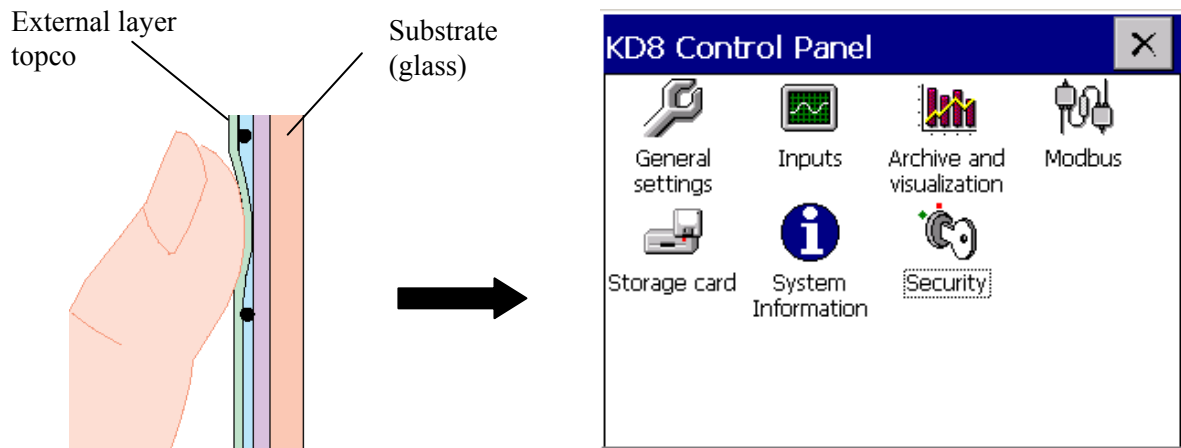

All elements of the user's interface (windows, icons, buttons) have dimensions adapted to be serviced by fingers – they do not require special tools.

After installing the recorder into the panel, remove the foil protecting the external flexible layer of the touch screen from the LCD screen.

Considering the sensibility of the touch screen to dirt and external damages of its surface and the substrate, one must observe following recommendations:

- protect against surges, they can damage the external surface or the glass substrate of the touch screen,

- protect against fluids, grease and aggressive chemical agents,
- touch only with fingers; do not use hard and sharp objects which can damage the flexible surface of the touch screen,
- clean softly with a cotton cloth impregnated with a detergent destined to clean LCD monitors (not containing alcohol, petrol or ammonia) or by using water with soap,
- observe the given temperature range of the recorder operation.

Since there is the possibility of a memory effect symptom occurrence on screens of LCD type (after a prolonged display of a constant figure), the blanking of the screen after a 15-minute continuous work is set in the recorder as a standard, without touching the screen.

The renewed activation of the screen follows after touching it.

The blanking time can be changed or this function can be disabled (see section 7.1)

4.2. CompactFlash memory card, USB interface, LED diode

A CompactFlash card with capacity up to 4 GB may be used for the measuring data storage in the KD8 recorder.

It is recommended to apply CF cards produced by SanDisk company, in the recorder.

Current measuring data, archive data and recorder configuration files are stored on the CF card.

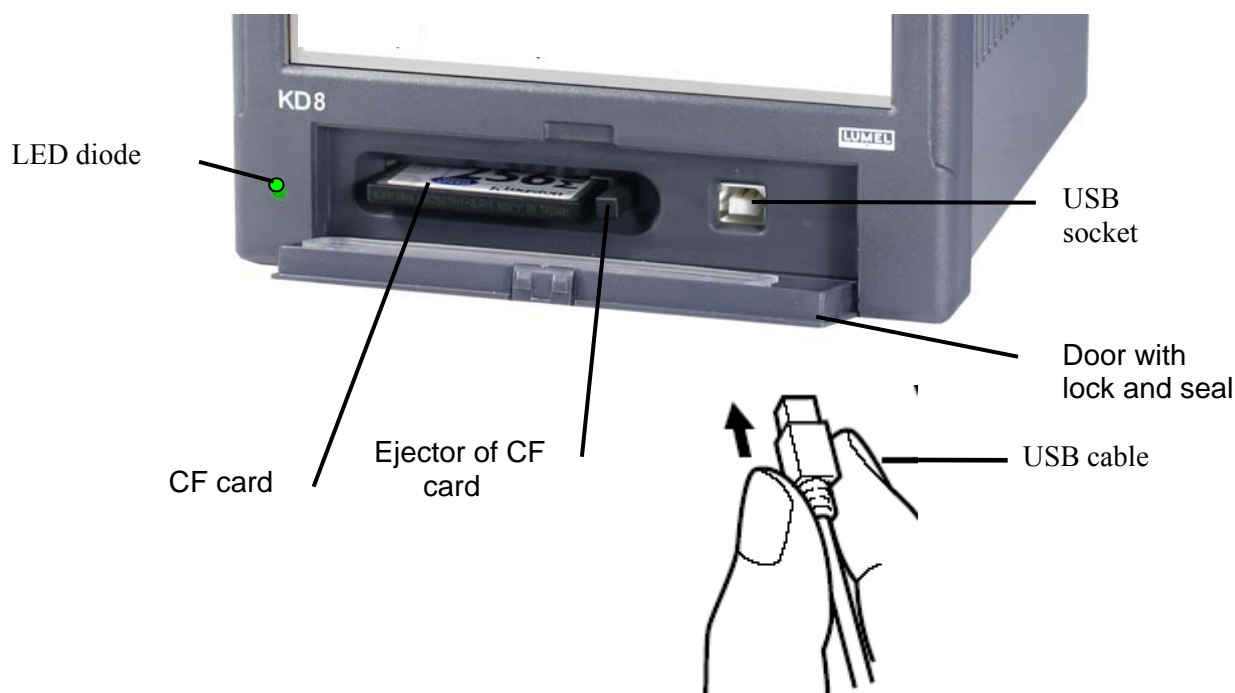

Frontal view of the recorder after opening the door

One can upload data stored on the CF card to a PC and record or erase files on the CF card through the USB interface.

To connect the computer to the recorder through USB socket, use delivered in standard accessories, the shielded USB AM-BM cable of 1.8 m long or another similar one of 5 m long (the USB bus operates correctly without amplification at the distance up to 5 m).

In order that the KD8 recorder was seen in a PC with MS Windows operating system and serviced through USB, one must install drivers and the **KD Connect** program from the delivered CDR being in the recorder accessories (for description and program installation (see section 9.1)).

The LED diode placed on the left side of the door signals the recorder operating conditions:

- Green colour of the diode – the recorder is set working, normal operating conditions
- Red colour of the diode – signals the storage of data on CompactFlash memory card. In these operating conditions, one must not take out the card from the seat **risk of loss of measuring data!**



4.3 Terminal plate

Programmable, universal measuring channels

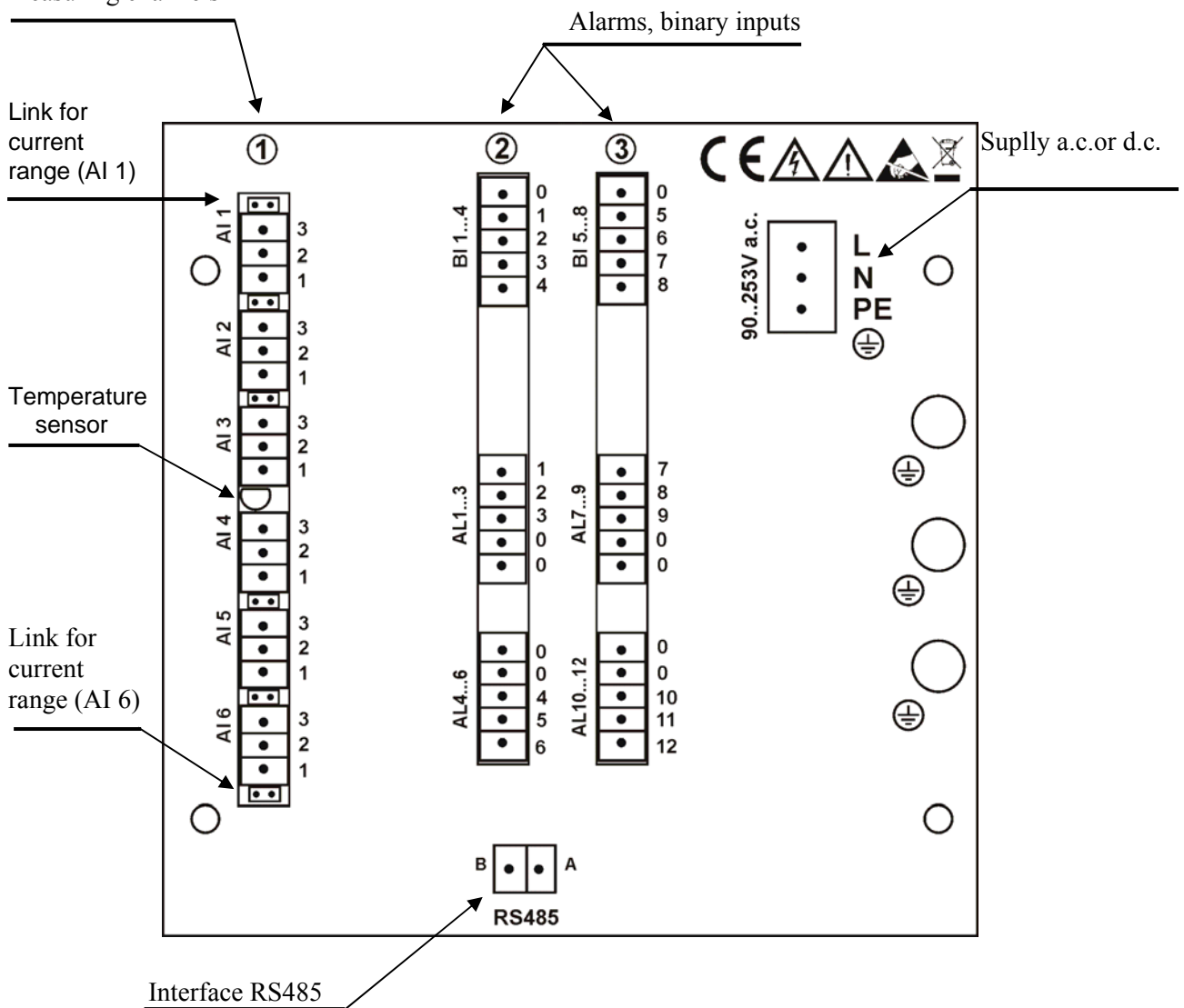

Symbol of terminal group	Terminal description
1	Connecting sockets of measuring packages (AI 1..6) - 3 or 6 measuring programmable inputs.
2 i 3	Connecting sockets for alarm packages (AL 1..12) and binary inputs (BI 1..8) (6 / 12 electromechanical relays and 4 / 8 binary inputs)
L, N, PE \oplus L+, L-, \oplus	Connecting sockets for supply voltage: 90... <u>230</u> ...253 V a.c. or 18... <u>24</u> ...30 V d.c..
RS485	Interface RS485
\oplus	Functional earth terminals (to connect screens from signaling wires)

4.3.1 Connection of analog signals

4.3.1.1 Programmable measuring inputs AI 1..6

Connection of voltage source

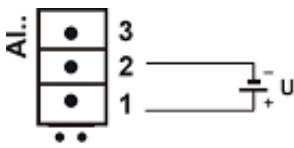

Connection of current source

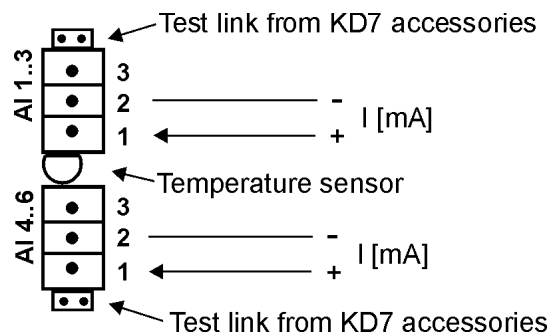

Connection of thermocouple TC

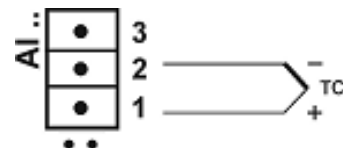

Two-wire connection:

- Resistance thermometer RTD

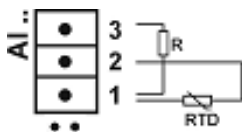

- Resistance transmitter

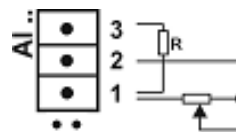

Note: the balancing resistance R should have a resistance equal to the total resistance of both connecting wires of RTD and transmitter with terminals

Three-wire connection:

- Resistance thermometer RTD

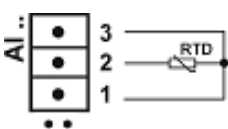

- Resistance transmitter

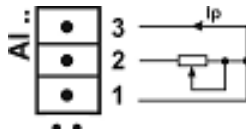

- Potentiometric transmitter

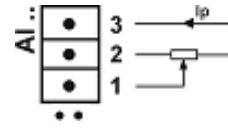

Note: wires connecting RTD with terminals 2 and 3 should have the same resistance

Table 1, Thermocouples : Colour codes

<i>Type of thermocouple</i>	<i>Material</i>	<i>British standard BS</i>	<i>USA standard ASTM</i>	<i>German standard DIN</i>	<i>French standard NFE</i>	<i>International standard IEC 584-3</i>
T	Cu-CuNi	+ white - blue * blue	+ blue - red * blue	+ red - brown * brown	+ yellow - blue * blue	+ brown - white * blue
J	Fe-CuNi	+ yellow - blue * black	+ white - red * black	+ red - blue * blue	+ yellow - grey * grey	+ black - white * blue
K	NiCr-NiAl	+ brown - blue * red	+ yellow - red * yellow	+ red - green * green	+ yellow - purplish red * yellow	+ green - white * blue
R S	Pt-Rh13Pt Pt-Ph10Pt	+ white - blue * green	+ black - red * green	+ red - white * white	+ yellow - green * green	+ orange - white * blue
B	Pt-Ph30Pt	Use copper wires	+ grey - red * grey	+ red - grey * grey	Use copper wires	
N	NiCrSi-NiSi	+ orange - blue * orange	+ orange. - red * brown	+ orange - red * brown	+ orange - red * brown	+ pink - white * blue
E	NiCr-CuNi	+ brown - blue * brown	+ brown - red * brown	+ red - grey * grey	+ yellow - purple * purple	+ brown - white * blue

4.3.1.2 Alarms AL 1..32 and binary inputs BI 1..16

- Connection to terminals of the alarm system with electromechanical relays **AL1..12**

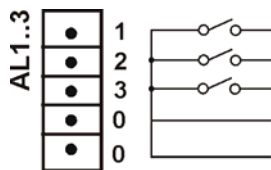

Alarms with electromechanical relays (**REL.**) are available with normally open contacts (**NO**), (see section 11: Order codes).

- Connection of the control signal to terminals of the binary input system **BI 1..8**

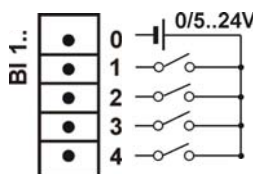

Binary inputs **BI1..8** are controlled by a signal:

- 0 V d.c. – inactive binary input or
- + 5... 24 V d.c. – active binary input.

4.3.1.3 Interface RS485 (Modbus Slave)

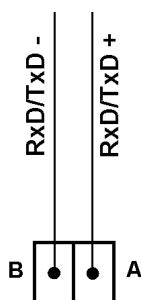

The RS-485 interface enables the readout of analog input values, binary inputs and the state of alarms from the recorder.

4.3.2 Recorder supply (AC or DC)

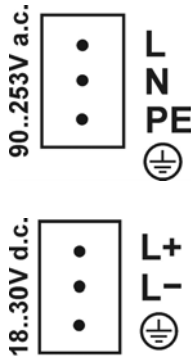

Caution: The recorder must be earthed or zeroed.

5. GRAPHICAL SIGNS ON THE RECORDER SCREEN



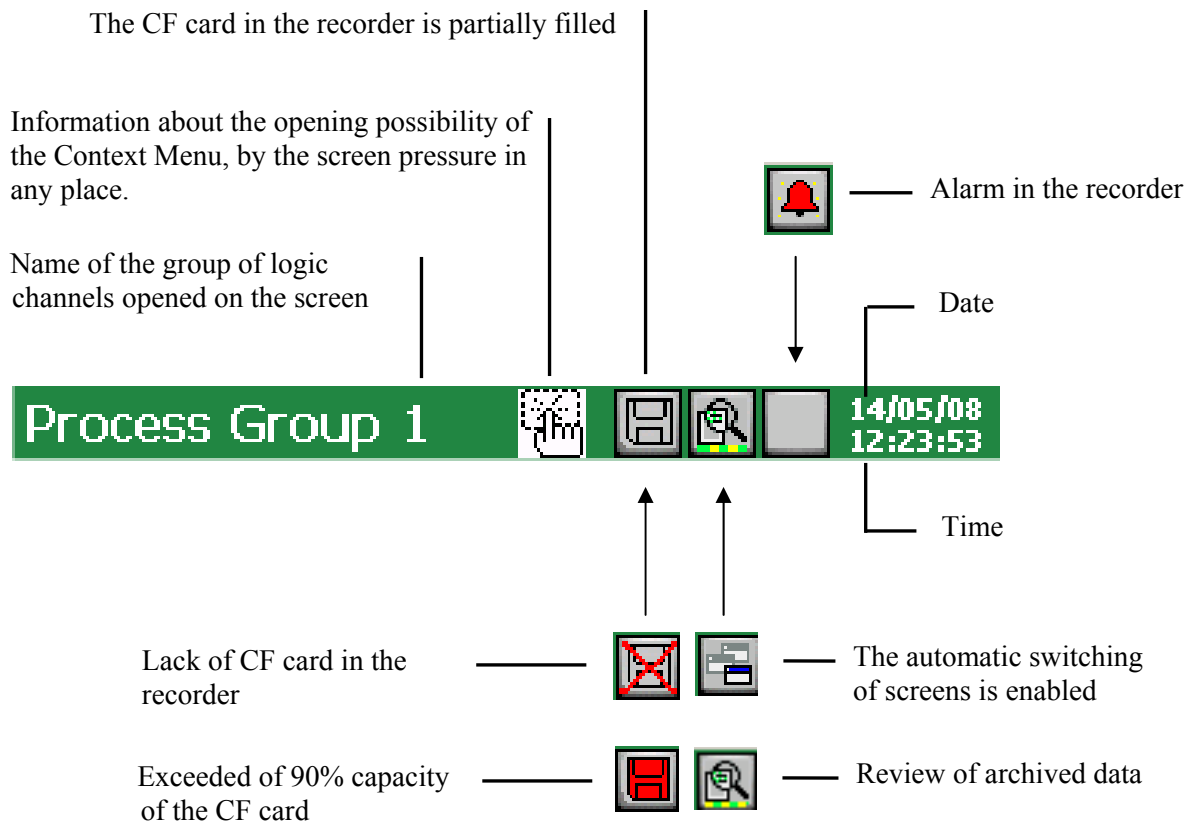





5.1 Status bar







5.2. Measuring views

	Range overflow in the channel over the upper limit, alarm state in the channel.
	Range overflow in the channel under the lower limit
	Signaling of the alarm occurrence in the recorder.

5.3. Service menu

	Selection approval, introduction of changes.
	Cancellation without introduction of changes
	Buttons for global navigation
	Buttons for navigation on accessible options
	Buttons for global copying of settings between menu windows
	
	Introduction of a number or a character string.
	Option selection from the list or the dialogue
	Context help

5.4. Information messages

	Warning
	Symbol of error occurrence
	Request
	Information icon

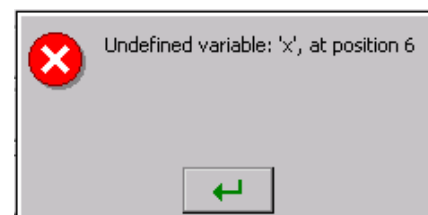
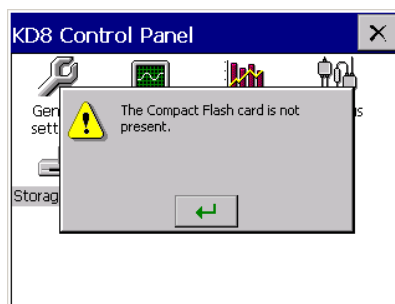
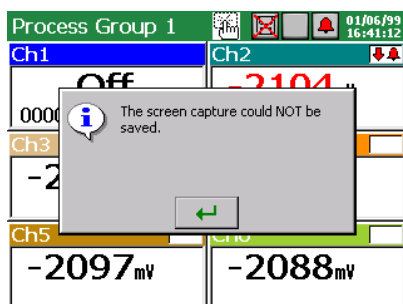

5.5. Dialogues

- Selection:

Single:

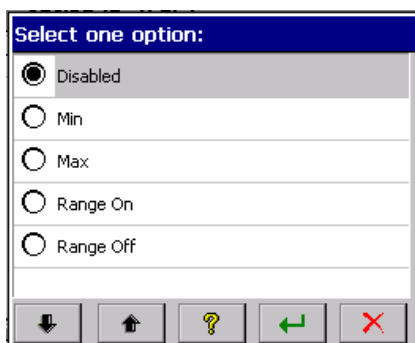

Multiple:

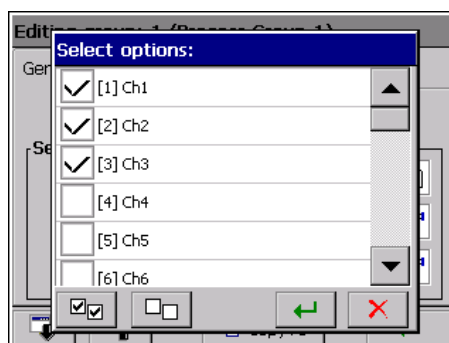

- Introduction of numbers

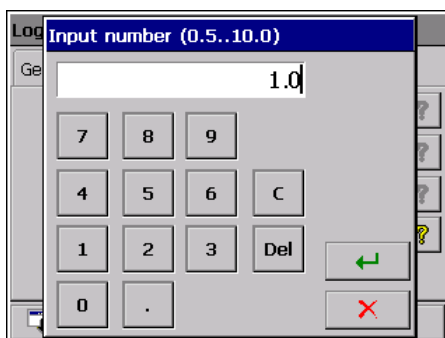

- Introduction of a character string (small and capital letters, numbers and special characters, password)

Small and capital letters

Numbers and special characters:

Password (replaced by dots):



6. STARTING THE RECORDER

After connecting the supply, the start screen appears with the producer's logo.

The logo is displayed during the time necessary for the initialization of recorder processes.

Next, the screen of data visualization appears, which was displayed at the last recorder disconnection from the network.

Touching the screen in any place brings the **Context Menu** up.

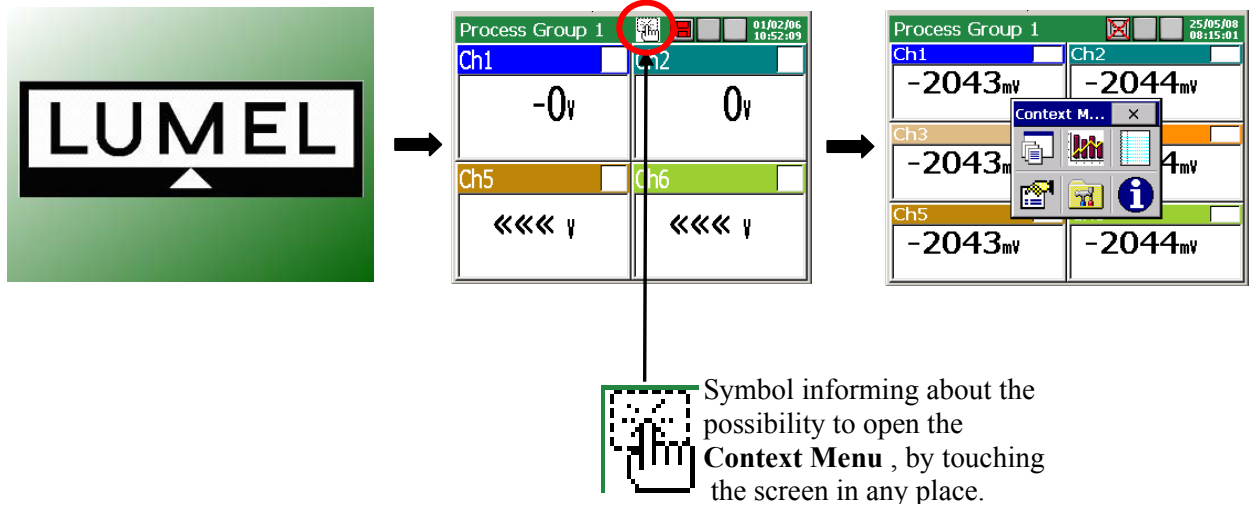

6.1 Context Menu

After **pressing the screen by a finger** (during the visualization of the measuring data) the **Context Menu** is displayed.

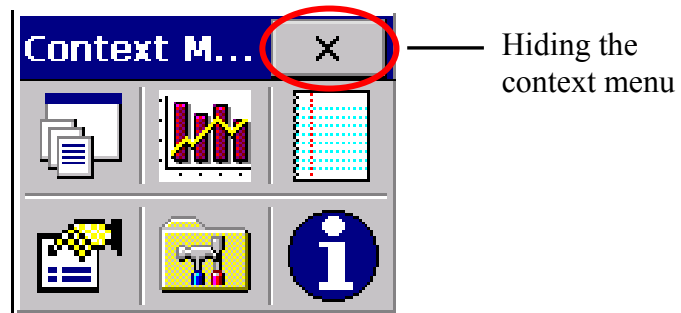

In the standard option, the basic set of functions necessary for the current service of the KD8 recorder is accessible in the menu.

	Selection for the edition of the next group from programmed measuring groups on the screen.
--	---

One can edit up to 2 measuring groups in the recorder. In each group, one can program up to 6 channels, from accessible 3 or 6 analog channels and 4 or 8 binary inputs, in the recorder. Programming of group parameters (see section 7.8)

	Switching of successive screens in the selected measuring group.
--	--

Programmed channels in the given group can be visualized in the following shapes: digital view, linear trend, bargraphs, analog meters and statistic screen.

Description and programming of visualization parameters see sections 7.8.2...7.8.6.

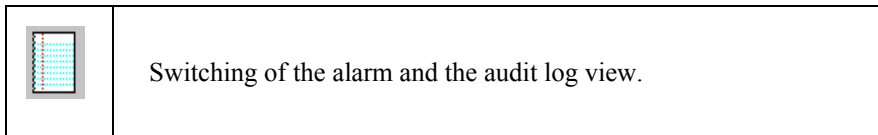

Information concerning events occurring during the recorder work is stored in logs (see section 7.12)

Caution: After exceeding the log capacity, the oldest events are overwritten in the view.

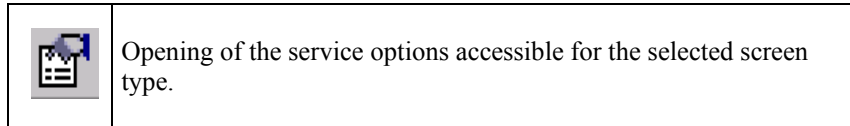

The window with systemic information from the KD8 control panel is accessible from the context menu.

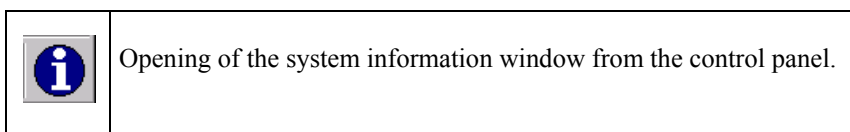

Following options are accessible for screens: digital, bargraphs, analog, and statistic.

- turn on/off the switching of screens (automatic switching), see section 7.8.7,
- recording of archive data on CF, see section 8.1.3,
- removal of the CF card, see section 8.1.6,
- confirmation of alarms, see section 7.7.2
- operator's messages, see section 7.13

Following options are accessible for the linear screen:

- time scale (for the screen),
- visualized signals,
- zoom signals, see section 7.9,
- transition to the archive mode, see section 8.2,
- turning on/off the switching of screen, see section 7.8.7,
- storage of archive data on CF, see section 8.1.6,
- removal of the CF card, see section 8.1.6.
- confirmation of alarms, see section 7.7.2
- operator's messages, see section 7.13

For each logs (alarms and audits) following options are accessible:

- Reset this log / Reset all logs / Filter by groups...
- Confirmation of alarms, see section 8.5.2

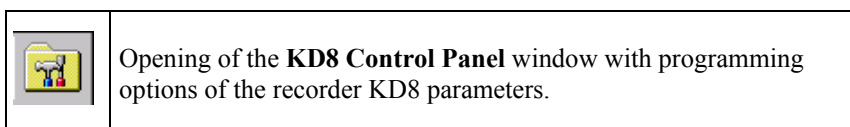

- transition to the configuration of recorder parameters in the “**KD8 Control Panel**” window, see section 6.2.

6.2. Entry into the recorder parameter configuration, “KD8 Control Panel” window

In order to enter the recorder configuration, one must select the **KD8 Control Panel** symbol in the **Context Menu**:

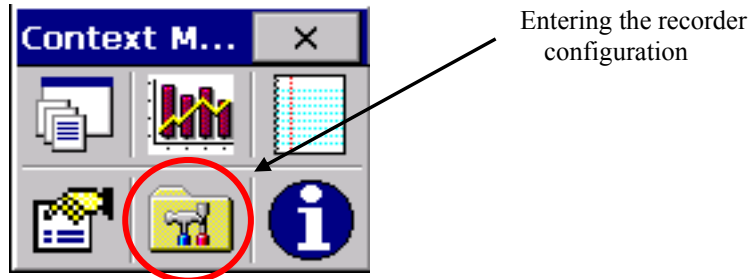

The window of the user’s selection appears, which will carry out the given configuration.

At first start, there is only the **Administrator** user. The logging follows without the password, after approving the window.

The **Administrator** after entering the **KD8 Control Panel** can edit the user’s settings.

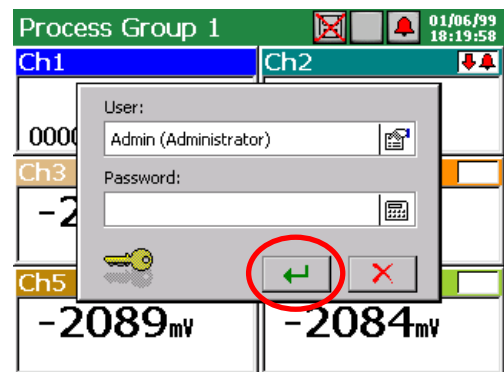

Next, one must choose the kind of the recorder parameter configuration in the **Configuration** window.

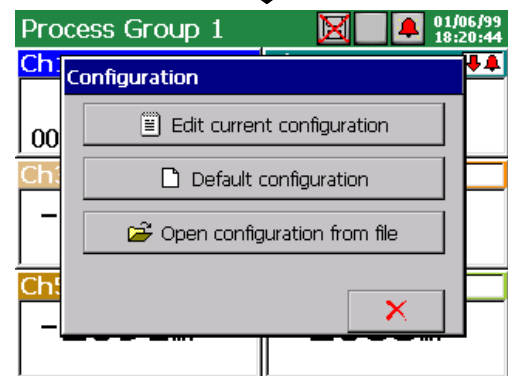

Default Configuration

- They are factory settings or given requirements concerning individual recorder settings.

Edit current configuration

- During the first start, it is the default configuration, at next starts, the changed configuration by the user in the KD8 Control Panel (see section 6.2).

Open configuration from file

- Configuration can be loaded from a file that’s on the CompactFlash card.

Information is displayed when selecting a file of another hardware configuration from the recorder

After accepting, the configuration file is converted and read in the recorder.

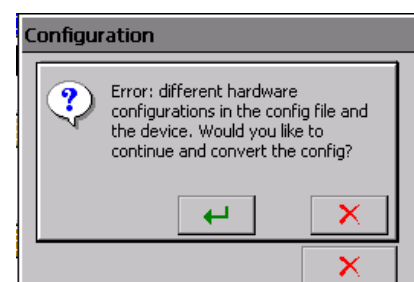

The **KD8 Control Panel** appears.
It is the initial point for carrying out the full configuration of the KD8 recorder.

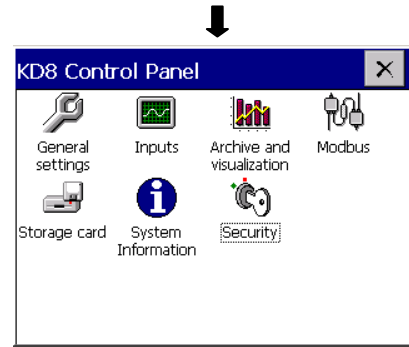

7. CONFIGURING THE RECORDER

The **KD8 Control Panel** is the window in which we obtain the direct access to the KD8 operating menu:

- general settings of the recorder, see section 7.1
- configuration of channels, see section 7.7
- configuration of alarms A1 and A2 in analog measuring channels, see section 7.6.
- setting of visualization and archiving parameters, see section 7.6
- configuration of event logs (alarms and audits), see section 7.12
- setting of RS485 interface parameters, see section 7.2,
- service of the CF card, review of files, see section 8.1
- read out of information about the recorder, see section 7.4
- setting of access principles to recorder configuration changes , see section 7.3

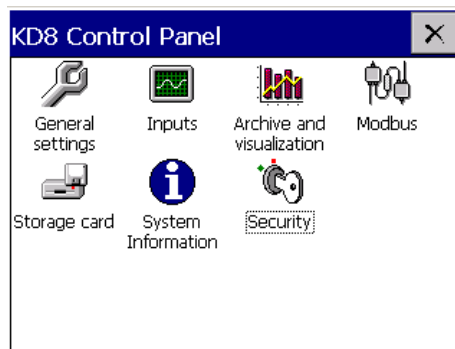

- Note:**
1. In descriptions of the KD8 Control Panel menu, exemplary data are written in *italics*.
 2. During the recorder configuration, the measurement and data storage is carried according to existing settings. When we enter new settings, after accepting changes, a break in storage, initialization of changes and starting of recording with new data follows. Only in case of the date change, the change is immediately introduced and the storage lasts acc. to the new setting.





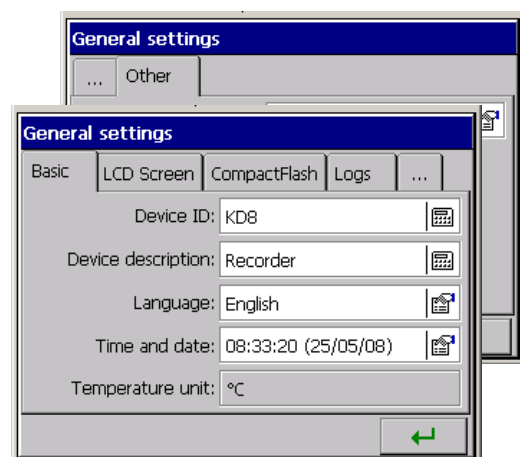

7.1 General settings



After pressing the  icon, the configuration of general parameters is displayed: recorder description, selection of the menu language, setting of the date and time, selection of the temperature unit, capacity of the event log (audits), time of screen blanking, setting of screen brightness. The procedure of the touch screen calibration is also accessible (see section 7.1).



Programming menu of general settings:

Basic	Device ID:	<i>KD8</i>		Description edition
	Device description:	<i>Screen Recorder</i>		Description edition
	Language:	<i>English</i>		Selection: - Polish, Russian, English, Italian, French, Romanian, German, Portuguese (Brazil)
	Time and date:	<i>12:00:00 (24/01/08)</i>		- Time setting: - Selection of the time zone - Setting of the automatic time change (summer/winter)
	Temperature unit:	<i>°C</i>		
LCD screen	Screen saver:	<i>15 min.</i>		Selection: - Disabled - 5,10,15,30 min. - 1,6,12 hours
	LCD backlight:	<i>100%</i>		Setting of the screen brightness
	Touch screen calibration:			See section 8.3
CompactFlash	Selection: fast formatting of CF card/full formatting of CF card			
Logs	Audit log size:	<i>50</i>		Edition of the parameter value
	Alarm log size:	<i>50</i>		
Other	Operator messages:	<i>MSG1...</i>		Choice: - Choice and edition of messages MSG1..10

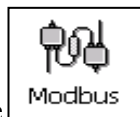

7.2 Modbus Slave configuration

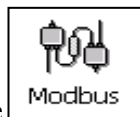

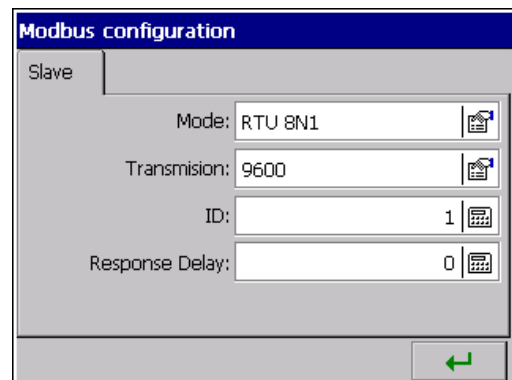
After pressing the  icon, the configuration window of the Modbus communication protocol is showed.



Programming menu of Modbus Master and Modbus Slave interface parameters:

Slave	Mode:	<i>RTU 8N2</i>		Selection: ASCII 8N1, ASCII 7N2, ASCII 7N1, ASCII 7O1, RTU 8N2, RTU 8E1, RTU 8O1, RTU 8N1,
	Baud rate:	<i>28800</i>		Selection: 300, 600, 1200, 2400, 4800, 9600, 14400, 19200, 28800, 38400, 56000, 57600, 115200, 128000, 230400, 256000
	ID:	<i>1</i>		Edition of the parameter value
	Response Delay:	<i>0</i>		

Note: 1. The register map is accessible in the user's manual of the Modbus communication protocol.
2. For the Modbus Slave protocol, actual measuring values, the state of binary inputs and state of alarms are accessible.



7.3 KD8 Security

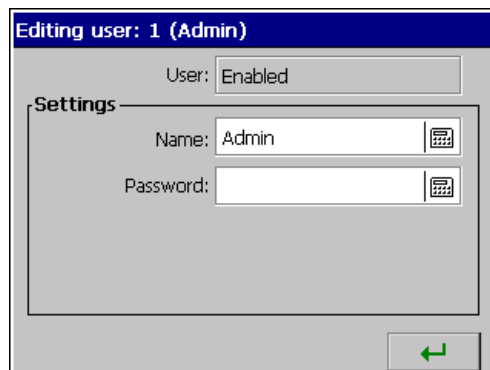

After pressing the icon, the name edition window of the recorder user and access passwords for the recorder configuration are opening.



Security settings for the recorder operator.

Editing user: 1 (Admin)			
Settings	Name:	<i>User 1</i>	 Name edition
	Password:	 Password edition

7.4 System information

After pressing the  icon, the window with information about the recorder system is opened. It informs about the hardware installed in the recorder and the state of the CompactFlash card and level of the internal buffers filling with data from the 1..2 measuring group. There is also the system updating service tab (see section 8.4) and the access for servicing personnel (the service of the recorder is only accessible for the manufacturer or distributors).

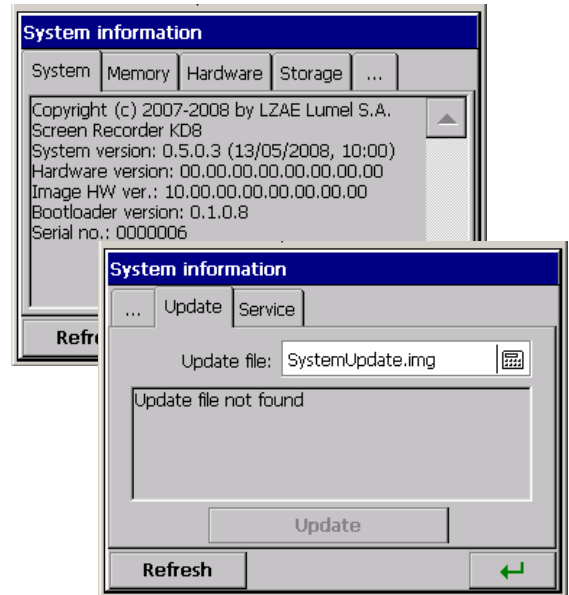

Systemic information and menu of system visualization:

Systemic information	System:	Information about the recorder: Name: <i>Screen Recorder KD8</i> Hardware version: <i>(Information for service needs)</i> System version: <i>0.5.0.3 (13/05/2008, 09:28)</i> Bootloader version: <i>0.1.0.8</i> Serial number: <i>00000000</i>		
	Memory:	Memory load: <i>48%</i> Available physical: <i>3.33 MB (3408 KB)</i> Total physical: <i>6.37 MB (6520 KB)</i>		
	Hardware:	Slot 1: <i>universal analog inputs (v10)</i> Slot 2: <i>empty or the name of introduced card</i> Slot 3: <i>empty or the name of introduced card</i>		
	Storage:	The Compact Flash card is not inserted <i>or information about the inserted card</i> CompactFlash card: <i>inserted</i> CF load: <i>85%</i> CF free space:: <i>2,31MB (2364 KB)</i> CF total space: <i>15,28 MB (15648 KB)</i> Internal buffer state: Information about the number of free records and KD8 worktime to fill the buffer of each active measuring groups.		
	Update:	Update file:		Selection: File browser – selection from the stored configuration files on the CF card.
		Updating:	Start of the system updating procedure	
Service	<i>Menu accessible for authorised users only</i>			

7.5. CF card



After pressing the  icon, when the CF card is inserted, the file browser window is opened. When there is no card, suitable message appears.

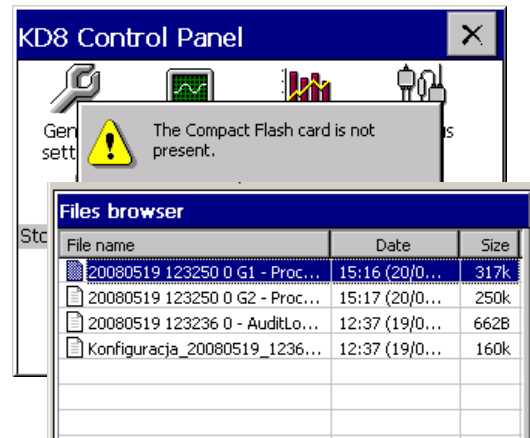





7.6. Configuration, visualization and archiving of the channel group

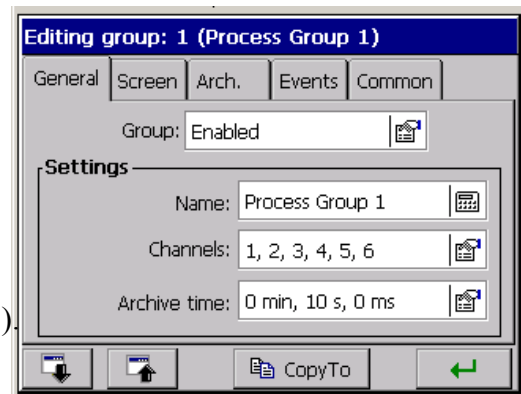











After pressing the  icon, the window of programming and visualization of 1 or 2 groups of channels is opening. One must define the group name, select 1..6 from accessible 7 or 14 channels in KD8 (3 or 6 analog inputs and 4 or 8 binary inputs) and program visualization parameters and data archive (see section 7.8).



Programming menu of the selected group of channels:

Edited group:		Selection of the group:	
		1 (Process Group 1) ... 4 (Process Group 4)	
General	Group:	<i>enabled</i>	 Selection: disabled / enabled
	Settings:	Name:	<i>Process Group 4</i>  Name edition
		Channels:	<i>1,2,3,4,5,6</i>  Selection: Select for the given group 1..6 channels from accessible in the recorder up to 14 channels (A11..6 i B11..8)
		Archive time:	<i>0 min., 10 sec., 0 ms</i>  Selection: Choice and edition of time base of time base parameters

Screen	Screens:	<i>1,2,3,4,5</i>	 Selection: Select 1..5 views of data presentation on the screen for the given group.
	Charts orientation:	<i>horizontal</i>	 Selection: Horizontal Vertical
	Line width:	<i>1</i>	 Selection: Selection of line thickness
	Background:	<i>Black</i>	 Selection: Black White
	<input checked="" type="checkbox"/>	Common settings for all groups (mark if common)	
Arch.	Alarms log:		 Selection: Off / On – Log archiving (storage in the file)
Events	Arch. disabled by:		 Selection: Select binary inputs which the logic state will have influence on event realisation. Archive. Data record on CF. Creation of a new file
	Save data on CF:		
	Create new file:		
Common <i>(Common parameters for the both groups master in relation to parameters set in each group)</i>	Auto-views delay:	<i>10 s</i>	 Edition Setting of the screen switching time in the given group
	Events:	<i>Lack,Lack,Lack</i>	 Select binary inputs which the logic state will have influence on event realisation. Archive. Data record on CF. Creation of a new file.
	Timeout for arch-mode:	<i>15 min.</i>	 Selection Setting of the time after which the automatic exit from the archive mode follows.
	File format:	<i>CSV</i>	 Wybór: CSV / CSV with digital signature/ Binary with digital signature
	Audit log (arch.):	<i>Enabled</i>	 Selection: ON/OFF – Archiving of the audit log (storage in the file)

Where: Storage period – period of data storage from the selected group into the memory.

Auto-views delay – switching period of screens into the given group

Charts orientation: vertical/horizontal – concerns the data visualization in the shape of linear charts and bargraphs.

Save data on CF: change of the chosen channel state (from 0 into 1) forces the storage of all data from the memory into CF.

Archive disabled by: the chosen channel state (1 / ON) disables data archiving.

Create a new file: the change of the chosen channel state (from 0 into 1) causes the creation of a new file with measuring data.

7.7 Analog and binary inputs

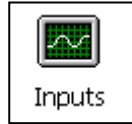

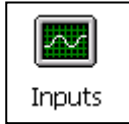
After pressing the icon  the programming window of 1...6 analog inputs is opening, with alarms A1 i A2 and 1..8 binary inputs.







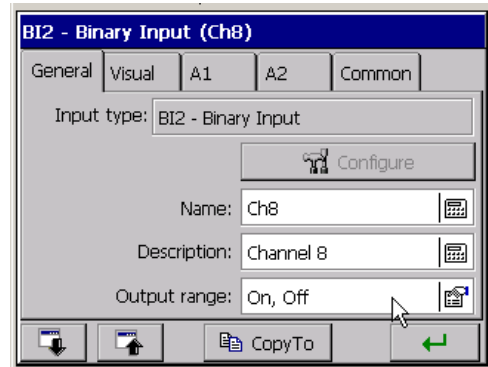
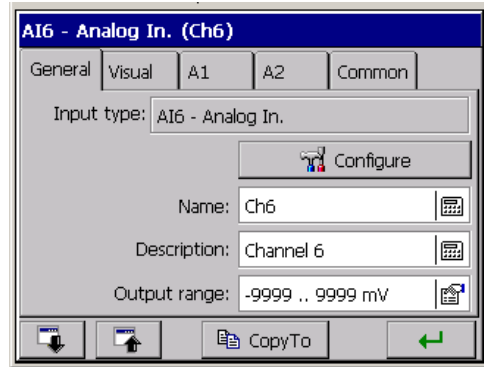

For each of selected analog inputs, one can choose and configure the type of the input signal, write the name and the description of the input, set the output range, the range colour on the screen and zoom of signals, program parameters of alarms A1 and A2.









As the common parameter, one can choose the binary input which the logic state 1 will block programmed alarms in all analog inputs.

For each of selected binary inputs, one must write the name and the input description and the label description of input logic states.



7.7.1 Programming analog inputs AI1...AI6

Input:   Selection : AI1...AI6, BI1...BI8 / Copy to: Copying of settings to th chosen analog/binary input.			
General	Input type:	AI1-Analog input ,0-10 V	Analog input: AI1..AI6
		 Configuration options of the chosen analog input.	
	Name:	Ch2	 Name edition
	Description:	Channel 1	 Name edition
	Output range:	-9999..9999 mV	 Edition of parameters: Precision, Min, Max, Unit or Copy from the input.
Visual	Color:	C=255, Z=140, N=0	 Selection of the diagram line colour on the screen
	Zoom scale:	0.0 – 100.0 mV	 Edition of parameters Min, Max or Copy from the input

Alarm: A1 / A2	Alarm type:	<i>Min</i>	 Selection: Disabled, Min, Max, Range On, Range Off	
	Alarm value:	<i>2.00</i>	 Edition of the parameter value	
	Alarm hyst.:	<i>Value; 0.00; 0 sec.</i>	Type:	Percentage, Value, Percentage Off, Value Off
			Percentage:	 Edition of the parameter value
			Hyst. value:	 Edition of the parameter value
			Time:	 Edition of the parameter value
	Alarm controls:	<i>Accept; None, Disabled</i>	Confirm type:	 Selection: None, Latch, Accept
			Alarm disabled by:	 Selection: None, Binary Inputs
			Input control:	Selection: Enabled/Disabled
	Alarm log:	<i>Enabled</i>	 Selection: On/Off – storage of the alarm in the log file	
Common	Alarms disabled by:	<i>Lack</i>	 Selection: Lack, Binary inputs B11..B18	

Output range: - During measurement of the input quantity, the proportional output value in limits defined by this parameter is displayed on the screen.

Zoom scale: - During the display of the analog screen (linear chart), after opening the context menu and selecting the option: **Zoom scale** in it, the selected channel is displayed on the analog screen, in limits defined by this parameter (see chapter 7.9)

Parameters common for all channels (can be globally modified through the change of each of them in any channel):

Alarms disabled by: - The activation follows if the selected source will be in the logic state 1.

7.7.1.1 Selection and configuration of an input for a channel.



Configuration: AI8 – Analog inputs			
General	Type of input signal:	<i>Voltage</i>	Selection of signal type
	Range:	<i>-9999...9999</i>	Range edition

- Selection of signal type:

- Parameters of the measuring system for the signal: voltage and current:

Input signal	Signal symbol in the menu	Measuring range	Minimal sub-range
Voltage	mV	0... ± 9999 mV	5 mV
Current	mA	0...± 20 mA	1 mA

Choose the type of the output signal and set the input signal. The value of the upper range limit (Max) must be higher than the value of the lower limit value (Min), preserving its minimal span acc. the table as above.

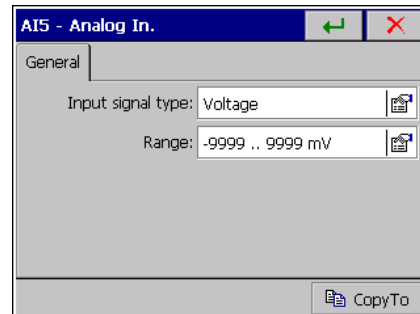

Next, write the name and signal description in, and set parameters of the output signal (Precision, Min, Max and unit). The signal type is set automatically as analog. One can also choose the option of parameter copying into the output from the measuring input.

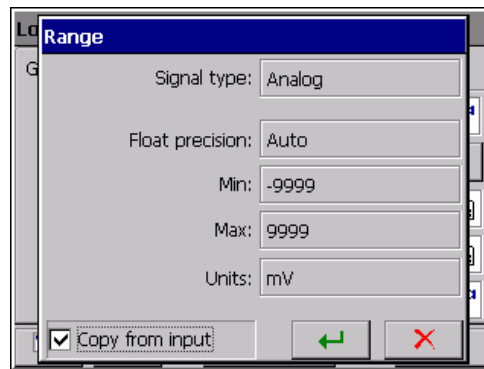
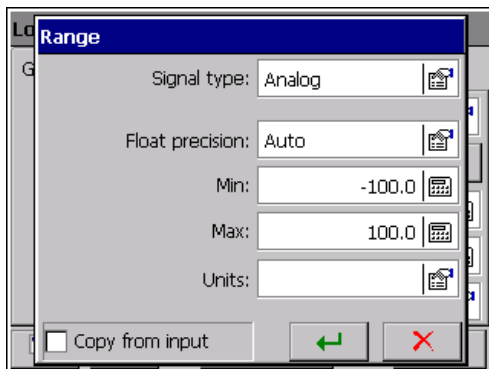

- Parameters of the measuring system for temperature measurement through a thermocouple (TC):

Input signal	Signal symbol in the menu	Measuring range	Minimal sub-range
J (Fe – CuNi)	TC J	-200...1200 °C (-328...2192 °F)	100 °C (212 °F)
K (NiCr – NiAl)	TC K	- 200...1370 °C (-328...2498 °F)	130 °C (266 °F)
N (NiCrSi – Ni Si)	TC N	-200...1300 °C (-328...2372 °F)	200 °C (392 °F)
E (NiCr-CuNi)	TC E	-200...1000 °C (-328...1832 °F)	100 °C (212 °F)
R (PtRh13 - Pt)	TC R	0...1760 °C (32...3200 °F)	540 °C (1004 °F)
S (PtRh10 - Pt)	TC S	0...1760 °C (32...3200 °F)	570 °C (1058 °F)
T (Cu- CuNi)	TC T	-200...400 °C (-328...752 °F)	110 °C (230 °F)
B (PtRh30 - PtRh6)	TC B	400...1820 °C (752...3308 °F)	1000 °C (1832 °F)
Thermocouples of L (TXK) and K (TXA) type acc. to GOST standards.			

After selecting the signal type, set the upper (Max) and lower (Min) limit of the input signal. The value of the upper range limit (Max) must be higher than the value of the lower limit value (Min), preserving its minimal span acc. the table as above.

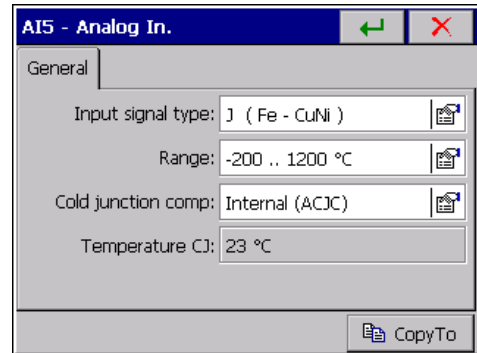

Cold junction compensation:

Defines the way of the thermocouple cold junction

- **Internal (ACJC):** Sets the self-acting cold junction compensation by the temperature sensor placed on the measuring package.
- **External:** the temperature of cold junction, 23°C set as a standard, can be changed.

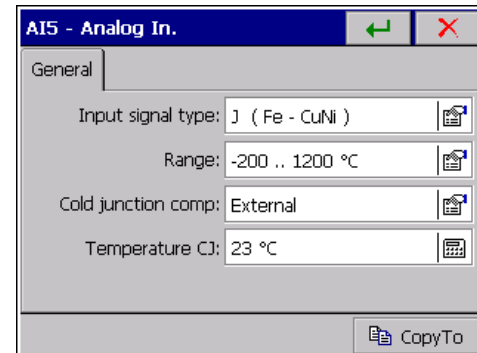

Next, write the name and signal description in, and set parameters of the output signal (Precision, Min, Max and unit). The signal type is set automatically as analog.

One can also choose the option of parameter copying into the output from the measuring input.

- **Parameters of the measuring system for temperature measurement through a resistance thermometer (RTD)**

Input signal	Signal symbol in the menu	Measuring range	Minimal sub-range
Resistance thermometer (RTD):			
Pt 100	Pt 100	- 200...850 °C (-328...1562 °F)	50 °C (122 °F)
Pt 500	Pt 500	- 200...850 °C (-328...1562 °F)	
Pt 1000	Pt 1000	- 200...850 °C (-328...1562 °F)	
Ni 100	Ni 100	- 60...180 °C (-76...356 °F)	
Cu 100	Cu 100	-50... 180 °C (-58...356 °F)	
Thermometer resistances PT and Cu (GR21, 50P, 100P, 50M,100M) type acc. to GOST 6651-78 and GOST6651-94 standards.			

After selecting the signal type, set the upper (Max) and lower (Min) limit of the input signal. The value of the upper range limit (Max) must be higher than the value of the lower limit value (Min), preserving its minimal span acc. the table as above.

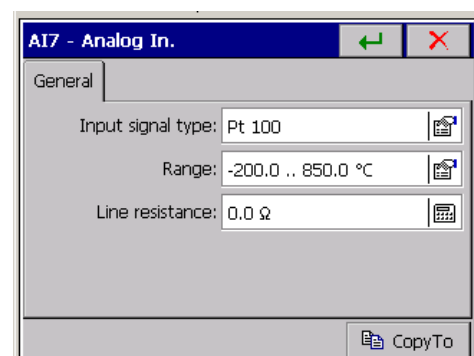

The way of the **Line Resistance** parameter programming depends on the way of the sensor connection.

- in a three-wire and two-wire connection with a balancing resistance, one must program the **0 Ω** value. Each another value will be treated as the line resistance and taken into consideration when calculating the measurement, what causes the error uprising.
- in a two-wire connection with an known resistance of the connecting line, program a value equal to the total resistance of both wires. The line resistance is introduced as a fixed-decimal value from the **000.0 ... 100.0 Ω** interval.

Next, write the name and channel description, and set parameters of the output range (Precision, Min, Max, and Unit). The signal type is automatically set as analog.

One can also choose the option of parameter copying into the output from the measuring input.

- **Parameters of the measuring system for resistance measurement through a resistance transmitter or a potentiometric transmitter:**

Input signal	Signal symbol in the menu	Measuring range	Minimal sub-range
Potentiometric transmitter	Pot. transm.	50...2000 Ω	100 Ω
Resistance transmitter	Res. transm.	0...2000 Ω	100 Ω

After selecting the signal type, set the upper and lower input signal limit. The value of upper range limit (Max) must be higher than the lower limit value (Min) preserving its minimal span acc. to the table as above.

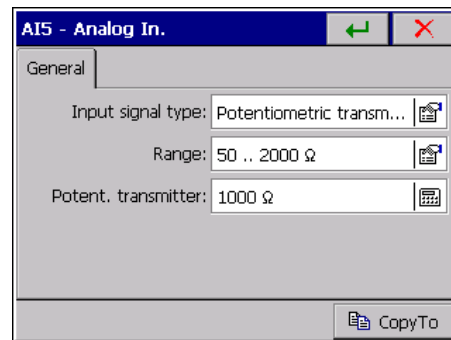

- For the **Potentiometric transmitter** range, program the true value of the transmitter resistance.
- For the **Resistance transmitter** range the programming way of the **Line resistance** parameter depends on the way of the transmitter connection:

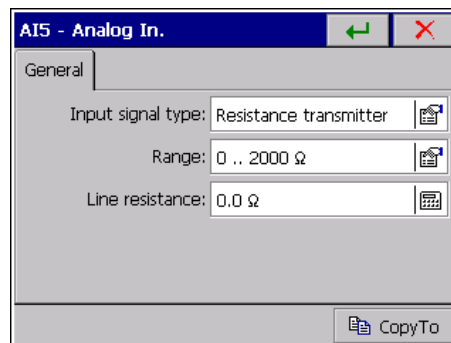

- in a three-wire and two-wire connection with a balancing resistance, one must program the **0 Ω** value. Each of another value will be treated as the line resistance and taken into consideration when calculating the measurement, what causes the error uprising.
- in a two-wire connection with an known resistance of the connecting line, one must introduce a fixed-decimal value form the **000.0 ... 100.0 Ω** interval.

Next, set parameters of the output range (Precision, Min, Max and Unit). The signal type is set automatically as analog.

One can also chose the parameter copying option from the measuring input to the output.

7.7.2 Programming of alarms (A1 and A2) in analog input configuration

Tabs of alarms A1 and A2 **concern only analog inputs**, for binary inputs they are disabled. In channels, choose and set alarm parameters in tags **A1** and **A2** (settings will be active after writing of the recorder configuration):

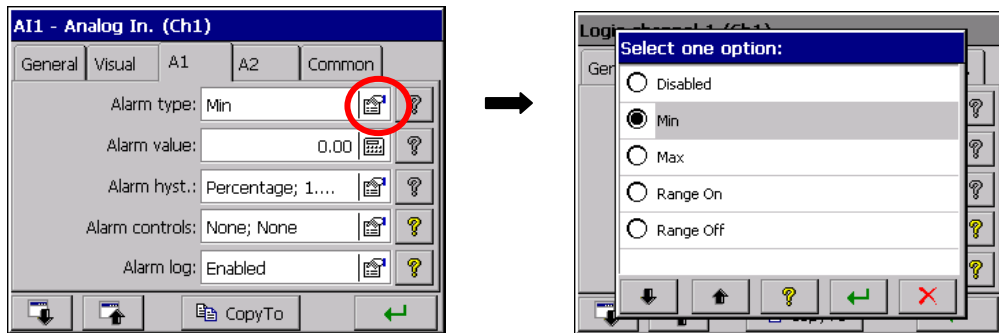

- **Alarm type:**

- **Disabled** or

- **Min, Max** - The alarm is switched on when the channel value is below /over the set alarm value

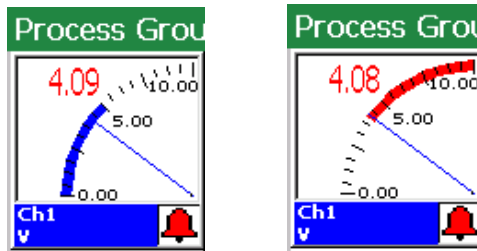

- **Range ON., Range OFF** – The alarm is switched on when the channel value is between/beyond set alarm values (lower limit, upper limit).

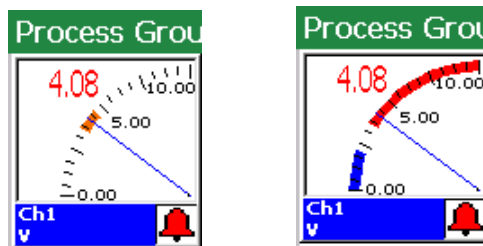

- **On Error** – alarm is activated if any error on input occurs (sensor break, communication error or range exceeding)

- **Alarm hyst.:**

- **Type** - Percentage, Value, Percentage Off., Value Off. (influence the state of the alarm switching on and off).

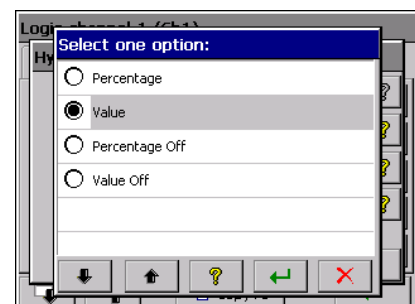

- **Percentage**
(for type Percentage and Percentage Off)
– *edition of values in percentage of the channel range.*

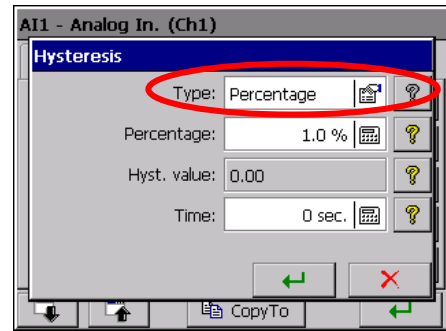

- **Hyst. value**
(for type Value and Value Off)
– *edition of values in channel range units (positive values)*

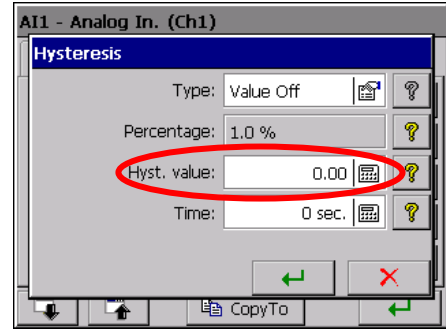

- **Time**
(hysteresis value in time units)
– *edition of values*

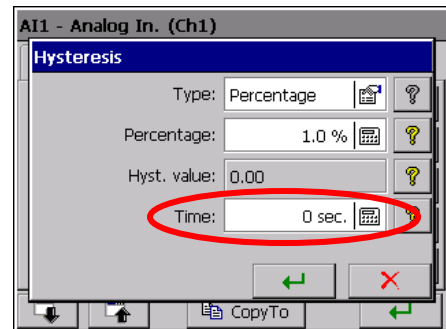

After programming the alarm hysteresis, valuable or in percentage, and temporary higher than zero, the action of the alarm follows when both conditions are fulfilled simultaneously.

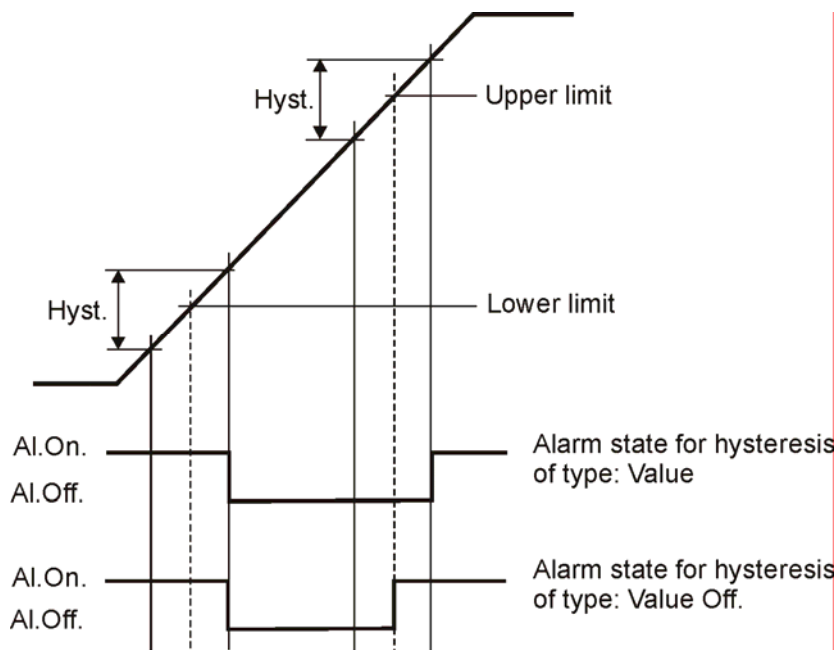

Fig. 1 Functional diagram of the **value Off** alarm type.

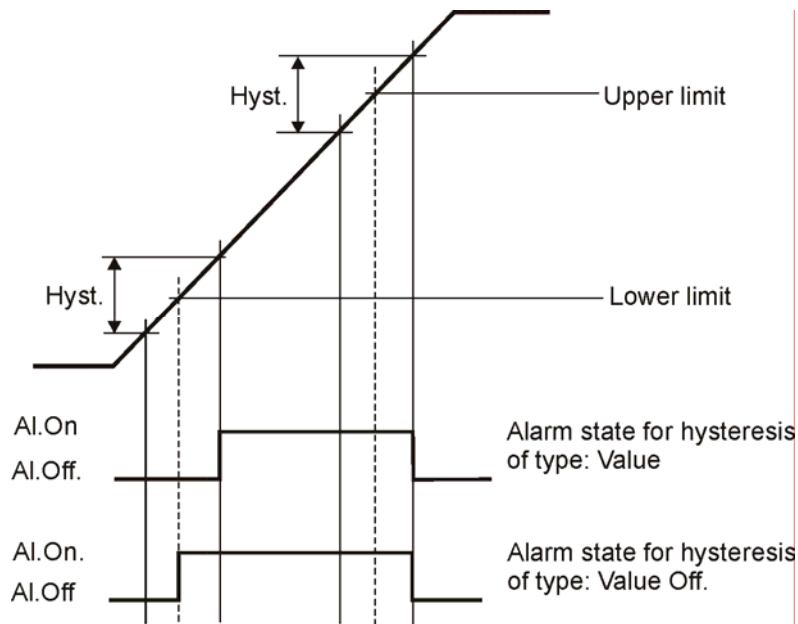

Fig. 2 Functional diagram of the **Value On** alarm type.

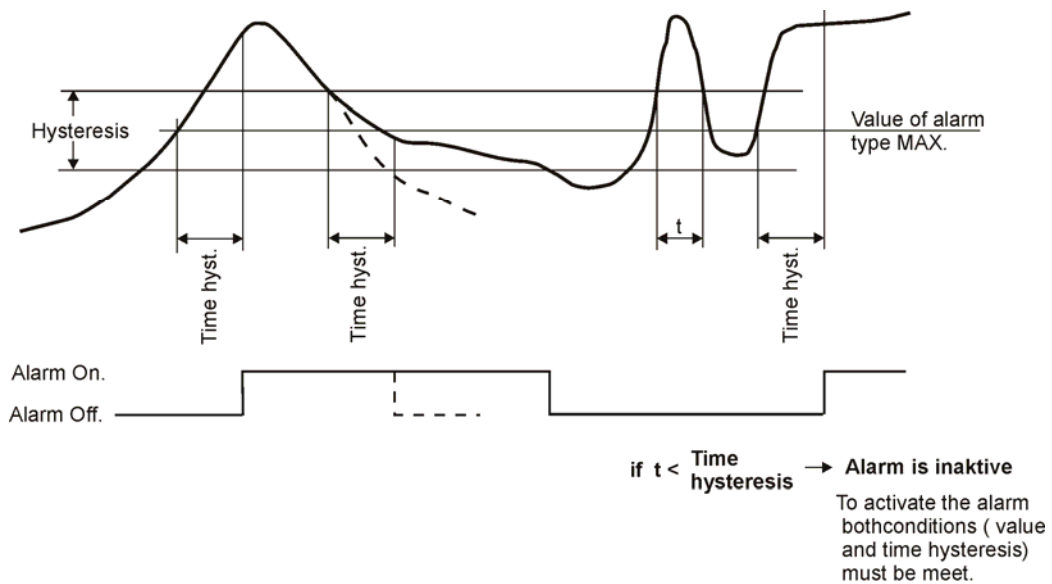
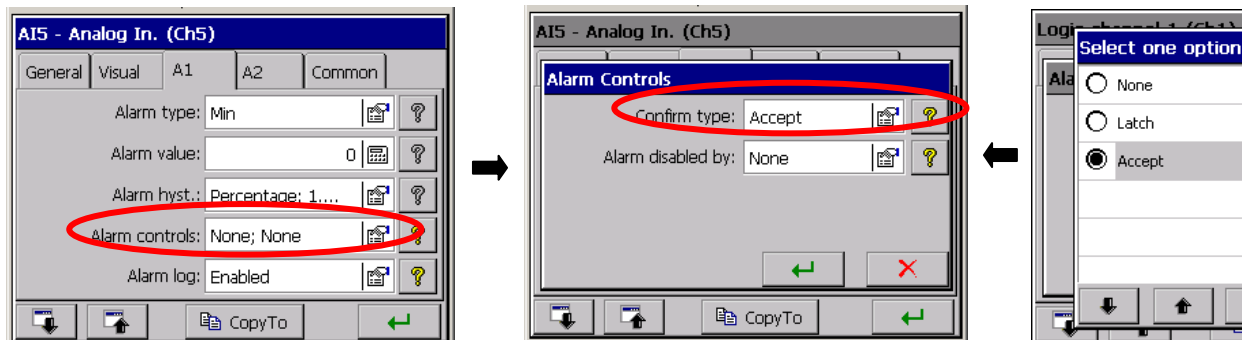

Fig. 3 Functional diagram of the MAX alarm type taking in consideration the hysteresis of **Value** and **Time** type

• **Alarm controls:**



- **Confirm type:**

None – option disabled

Latch – the alarm state is supported in the recorder till it will not be confirmed by the operator.

Accept – switching off the alarm state in the recorder by the operator.

During the recorder operation, one can choose in the context menu, the option of alarm confirmation acc. to programmed settings above.

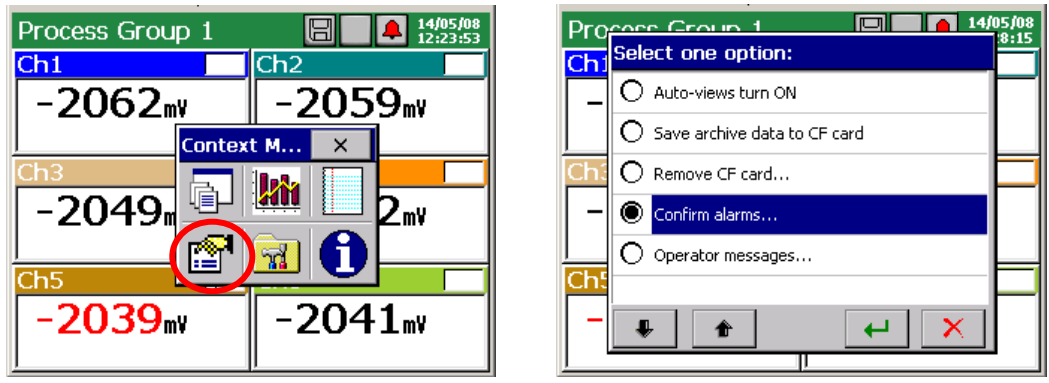

The options in the alarm confirmation menu are protected by the user's password.

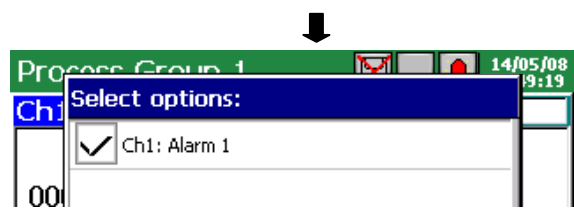

- **Alarm disabled by:**

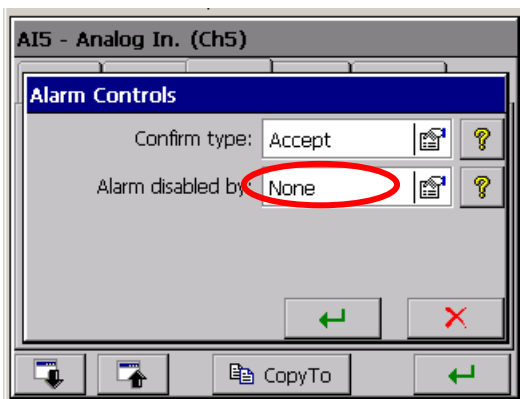

Lack – option disabled

Binary input BI 1...BI8 – selection of the binary input which the logic state 1 (ON) will block the current state of alarms.

The setting concerns the selected analog input.

If in settings of the currently chosen analog input or another, in the **common** tab, the alarm blocking by another binary input is set, then this setting as master will decide about the alarm blocking, in this and other analog inputs (see section 7.7.4.).

- **Error handling:** Ignore input errors, Alarm ON/OFF if input error occurs. Error situations are: communication break and sensor error. A range exceeding is not such event.

- Storage in the log

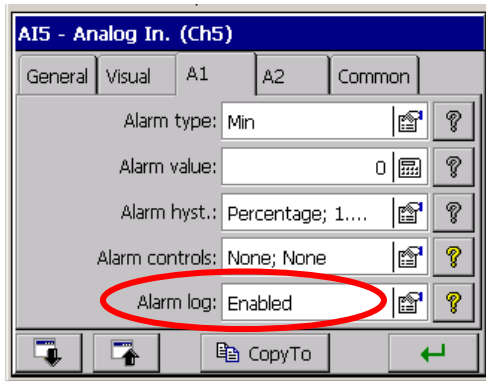

Disabled/Enabled – Storage of alarm messages in the alarm log.

7.7.3 Configuration of BI1...BI8 binary input parameters

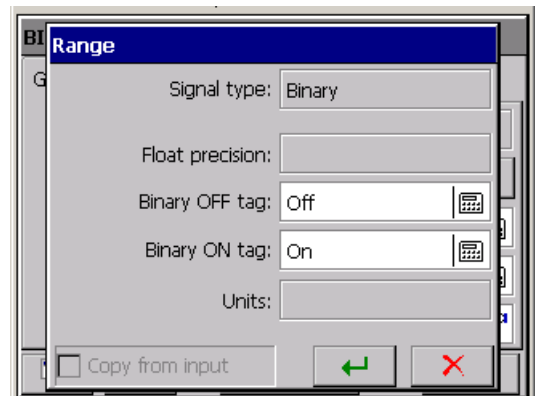
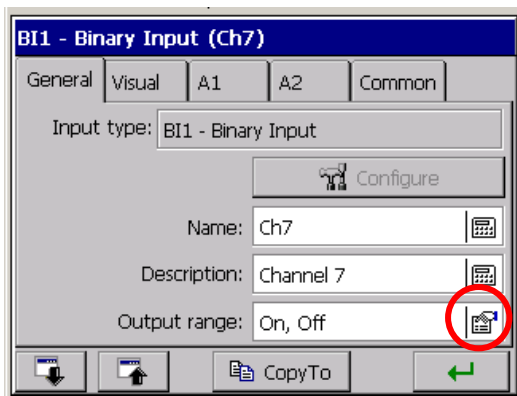

The signal type of the output channel is set automatically as **binary** and will be visualized and archived in this form.

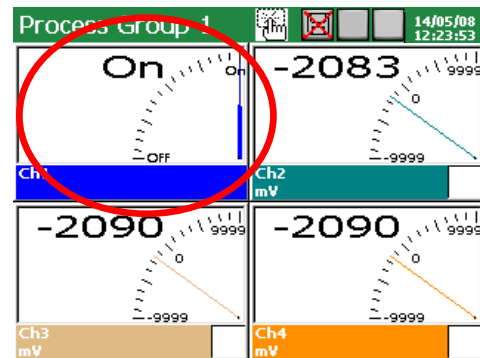
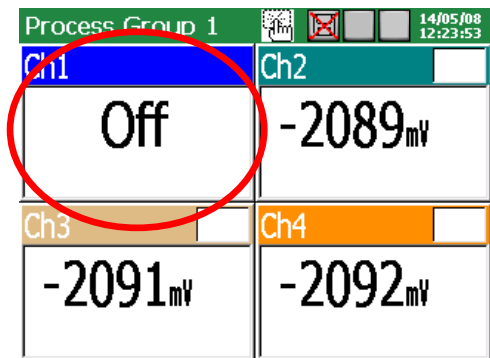

Write the name and channel description in the **General** tab and the description of output logic states 1 and 0 of the channel (as standard, it is **ON** and **OFF**). Programming of alarm parameters in disabled (**A1** and **A2** tabs).

Parameters set in the selected channel in the **Common** tab concern all remaining channels. In each of other channel, they can be modified.

7.7.4 Common parameters for binary inputs

In the **Common Binary Input** tab, one can choose the binary input 1...8 which the logic state 1 (ON) will block the current state of all alarms in measuring inputs.

It is a common setting (master) for all analog measuring inputs. It can be changed in the level of each another analog input.

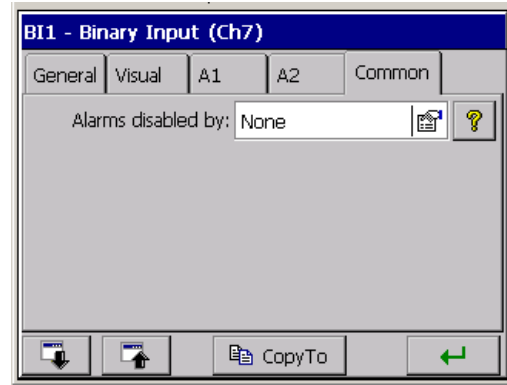

7.8. Programming of measuring groups

For the visualization and analysis of measuring data related e.g. with the defined technological process, one can connect channels in 1..2 measuring groups (each with 1 .. 6 channels) for which an individual set of parameters is chosen.

After selecting in the **KD8 Control Panel** window the icon

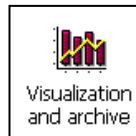

, the window of channel group edition is open.

7.8.1 Programming of group parameters

For each edited group of channels (**KD8 Control Panel** → **Visualization and Archiving** → **Edited group**) in the **General** tab, one can select 1...6 channels (analog and binary inputs) presentation from 14 accessible (for executions with 6 measuring inputs and 8 binary inputs), channels in the recorder, write the group name and set the time base for the group.

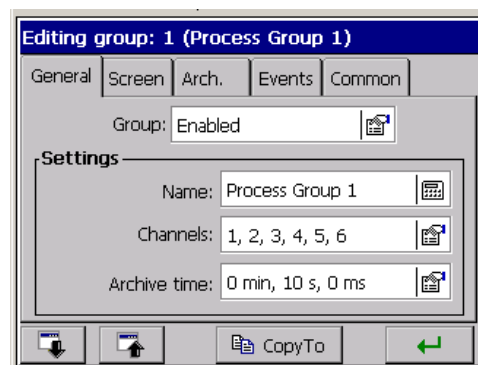

In the **Screen** tab, one can choose screen views for presentation in the given group (1-digital view, 2-linear 3-bargraphs, 4-analog, 5-statistics,), the screen orientation (horizontal or vertical), the line thickness for the line screen and the screen background (black or white).

The working state of the **Alarm log** and **Statistic log** is set in the **Arch.** tab. When the log is **Disabled**, it is displayed on the screen but it is not saved on the CF card. When it is **Enabled**, it is displayed on the screen and saved on the CF card (see section 8.1.3).

In the **Event** tab following parameter are set:

- **Archive disabled by:**
Archiving of measuring data of the group is Disabled by the logic state 1 (ON) of the chosen binary input.
- **Save data on CF:**
The forced storage of the newest group data from the buffer to the CF card follows at the moment of changing the input state of the selected binary input from 0 (OFF) to 1 (ON). Independently of this event, data are periodically stored in the CF card.
- **Create new file:**
The forced creation of a new file with group data follows at the moment of changing the logic state of the selected binary input, from 0 OFF) into 1 (ON).

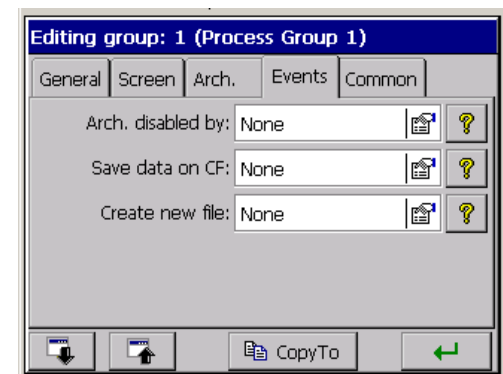
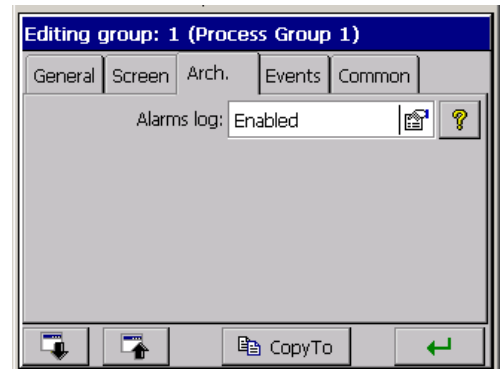
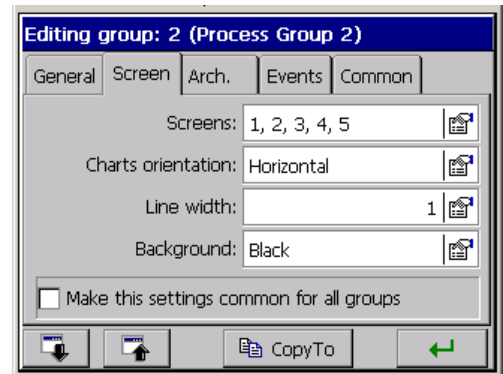

Configuration parameters common for **all channel group** programmed in the recorder are set in the **Common** tab:

- **Auto-view delay:**
Time of screen switching enabled by the user in the context menu option (see below)
- **Events:**
 - **Archive disabled by:** Lack/Disabling of data archiving follows when the logic state of the selected binary input is 1 (ON), see the **Note** below.
 - **Save data on CF:** Lack / Forced storage of the newest measuring data from the buffer on the CF card follows at the moment of changing the state of the selected binary input from 0 (OFF) to 1 (ON). Independently of this event, data are periodically stored in the CF card.

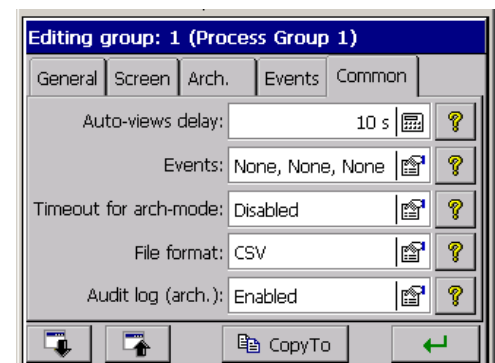

The analog output value of the channel **higher** than zero is interpreted in KD8 as a logic state (ON) of the given channel.



- **Create new files:** Lack/New files with data of measuring groups will be created at the moment of changing the logic state of the selected binary input from 0 (OFF) into 1 (ON).
- **Output time from the archive:** The set time of automatic output from archive data review, in case when the user forgot to close it. The time is counted from the last pressure of the button in the context menu.
- **File format:** Selection of the format which measuring data on the CF card will be stored in, CSV with the digital signature or CSV without the digital signature (see section 7.10)
- **Audit log:** When it is **Enabled** it is displayed on the screen (see section 7.12) and saved on the CF card. When it is set as **Disabled** it is displayed on the screen, but it is not saved on the CF card.

Parameters in the **Common** tab can be modified from the level of each other measuring group.

Each from channel groups can be disabled. Measuring data from particular groups are stored in the CF memory card of 8 MB capacity, in the format *.csv or binary.

The text file in format *.csv is serviced by the Excel program, and the binary file can be reviewed in the KD Archive program (see section 9.4).

Structure of the channel group file stored in CF card, with measuring data:

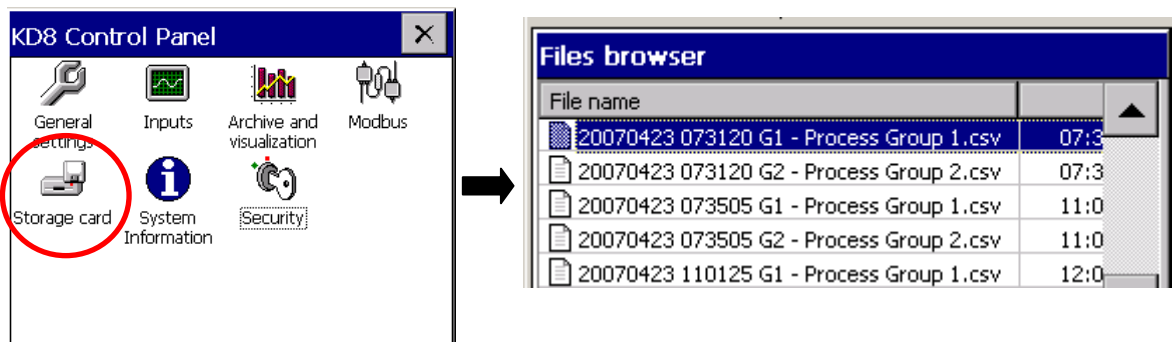

19000101 000003 0 - AuditLog.csv	11:1
20080514 100030 0 G1 - Process Group 1.csv	11:1
20080514 100030 0 G2 - Process Group 2.csv	11:1

Year, Month, Day

Hour, Minute, Second, Group symbol

File name

During the display of measuring data, one can switch screen views manually through successive pressures of the view icon in the **Context Menu**. One can also in the option window enable the previously (see above) programmed automatic cycle of their switching.

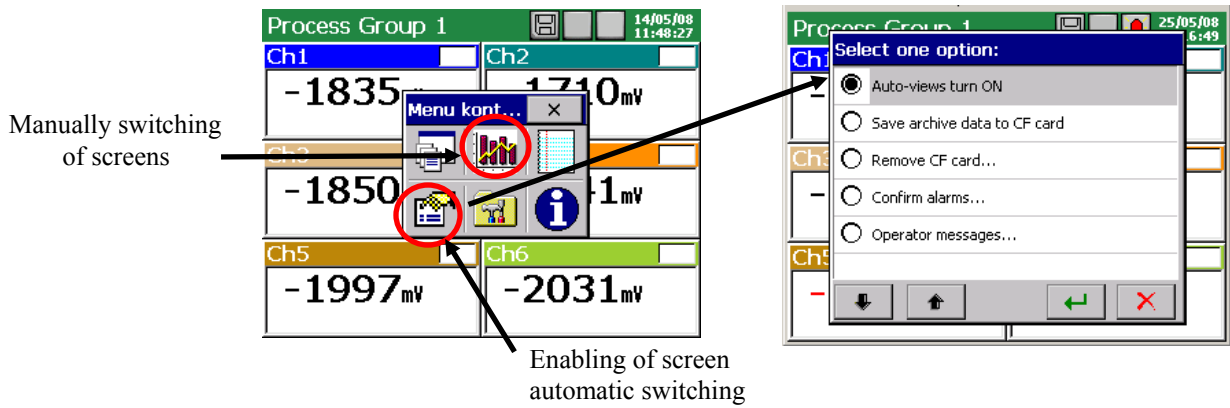

Information about the current recorder operation state are displayed on recorder screens, actual measurement value, alarm information, range overflows, sensor breaks, lack of data, and on statistics and bargraph screens, information about minimal and maximal measurement values in the current session period of the recorder operation.

7.8.2 Digital view of channel group.

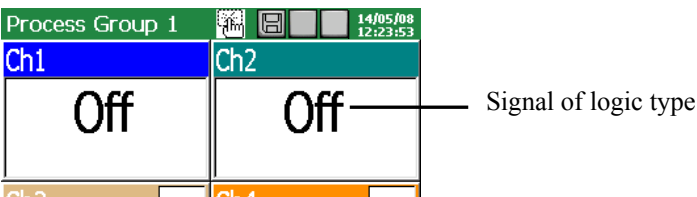
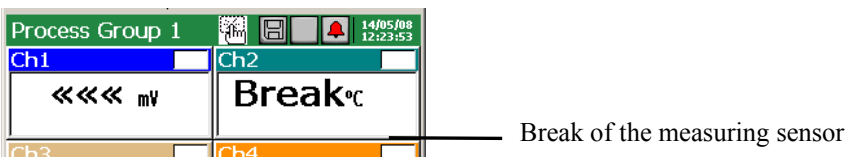
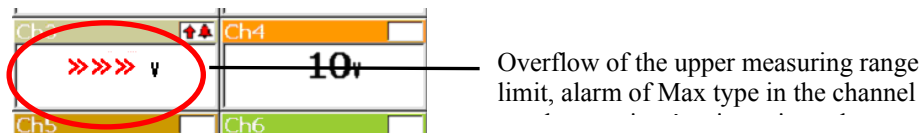
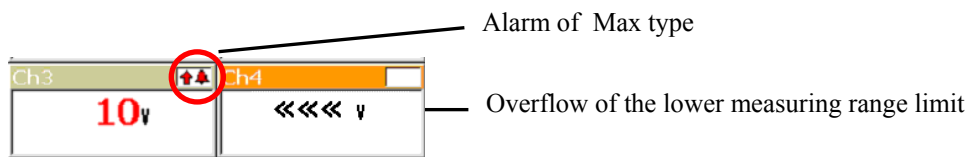
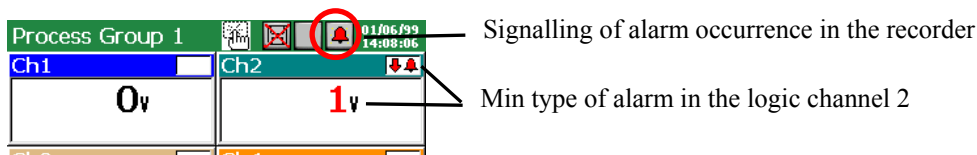

The type and the alarm value, in the given channel, can be read out in the **KD8 Control Panel**, in the menu of the **Input** icon.

7.8.3 Linear chart of the channel group

The chart orientation (horizontal or vertical), the thickness of the signal line and the screen background (black or white) are selected in the edition menu of the channel group.

- Horizontal chart:

Alarm in the 6 th channel

Sensor break

After pressing on the field of the selected channel, the description of the analog scale is switched on the programmed output range in this channel.

AI1 - Analog In. (Ch1)

Output range: 0.00 .. 40.00 mA

The entry to the option **Servicing of archive data** (see p. 8.2) is accessible during the display of the screen with the linear chart (horizontal or vertical). When browsing archive data, the icon informing about the operation in this mode is displayed on the screen.

Recorder in the review mode of archived data

To change the screen view from horizontal into vertical (concerns the linear screen and bargraph), one must choose the vertical chart orientation in the **KD8 Control Panel – Visualization and archiving** (see p. 8.2.1), in the **Screen** tab.

For the linear chart (horizontal and vertical) one can select the view background and thickness of the chart line.

Editing group: 2 (Process Group 2)

Charts orientation: Vertical

Line width: 1

Background: Black

Binary type of the signal.
 After pressing the field of the selected channel, the scale description is switched on the programmed output range 1 (ON) / 0 (OFF) of the given channel

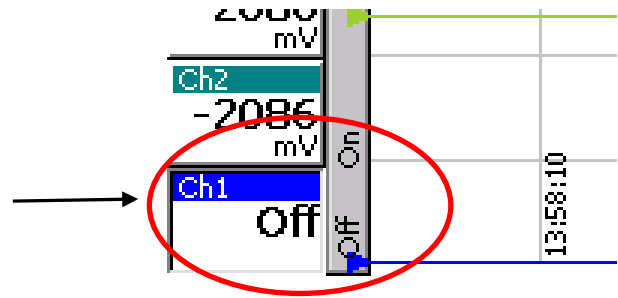

- Vertical chart:

Alarm in the channel

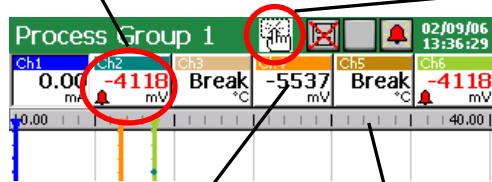

Information about the possibility to open the context menu through a finger pressure on the screen.

Sensor break

View of the output range scale for the 1 th. channel (switching of the scale follows after pressing the field of the selected measuring channel).

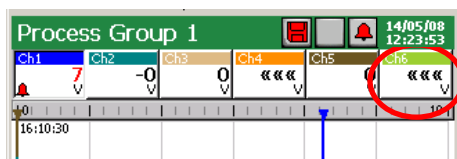

Overflow of the lower limit of the measuring range in the 6 th channel.

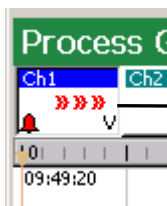

Overflow of the upper limit of the measuring range, alarm in the channel.

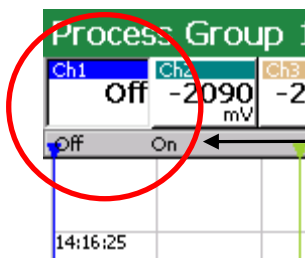

Binary type of signal.
 After pressing on the field of the selected channel, the scale description is switched on the programmed output range 1 (ON) / 0 (OFF) of the given channel.

Settings of the type and alarm value in the selected channel can be read out in the **KD8 Control Panel channel**, in the **Input** icon menu, **A1 and A2** tab.

7.8.4 View of the channel group in the bargraph form

- Vertical:

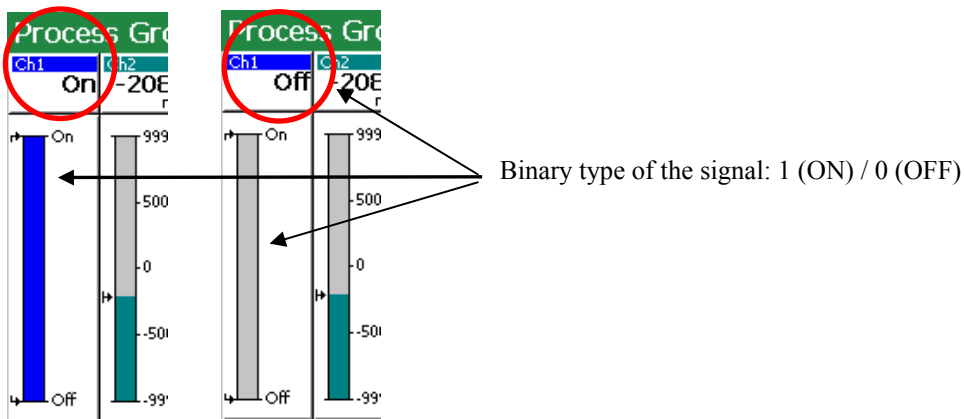
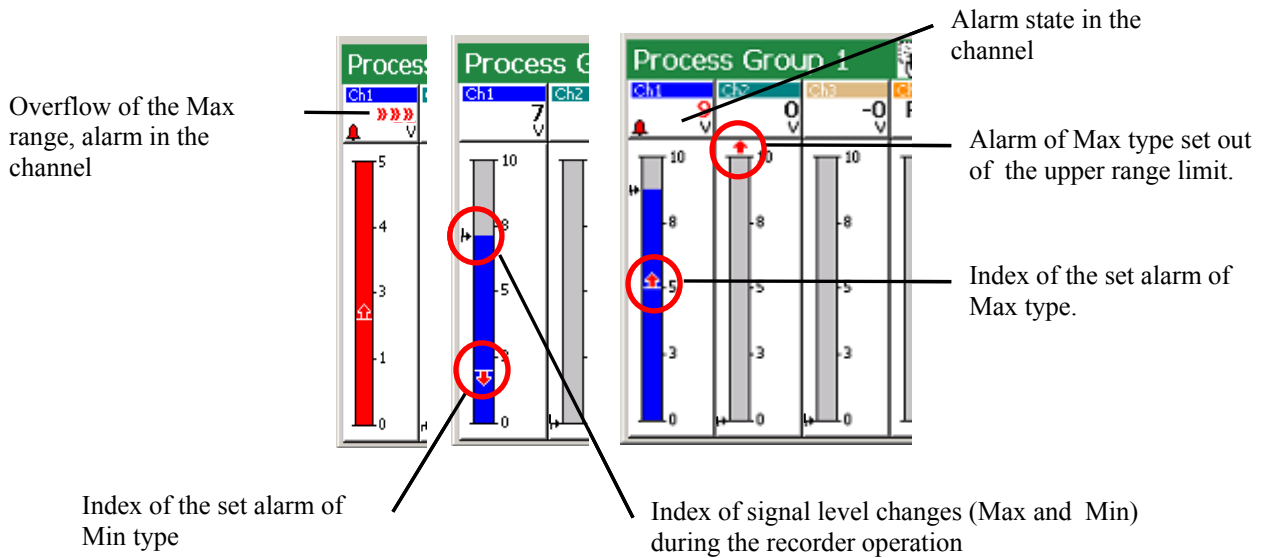

- Horizontal:

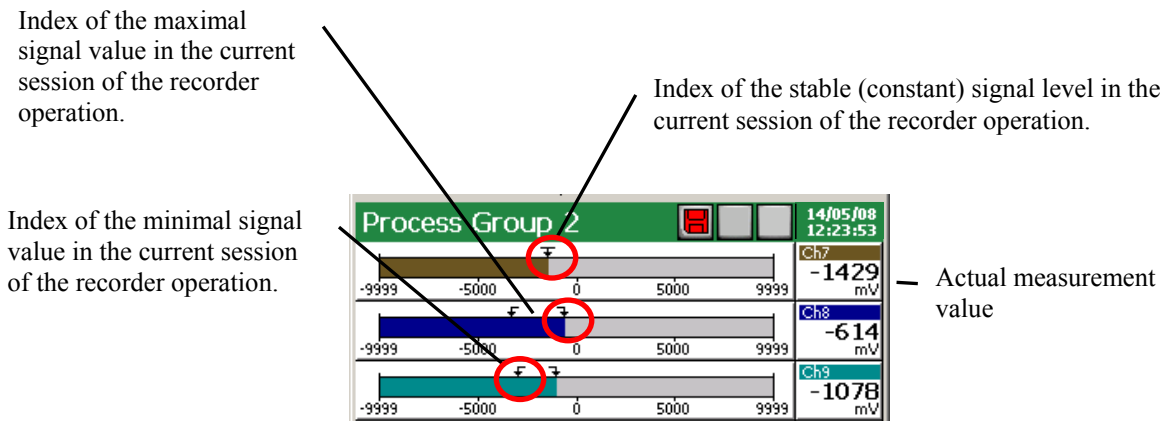

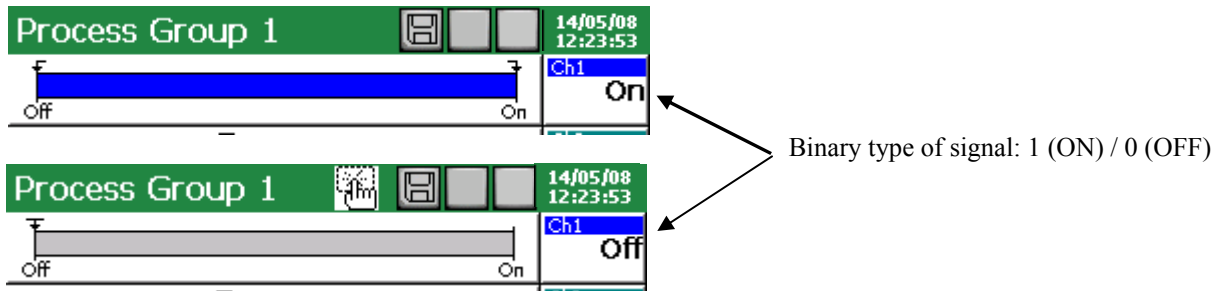
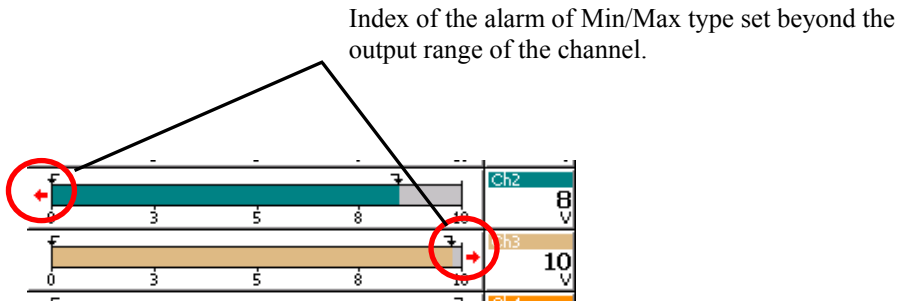
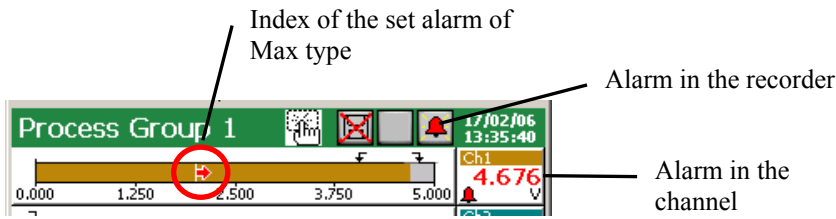

7.8.5 Analog view of the channel group

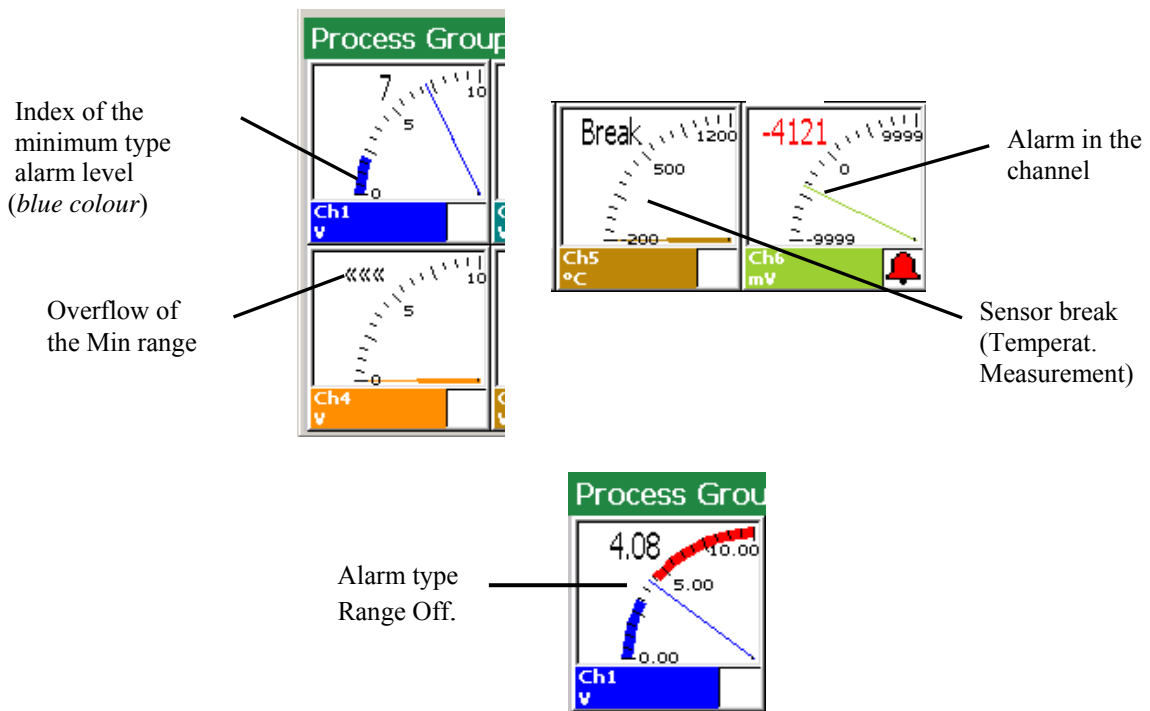

The set area of the Min type alarm is marked in blue colour on the analog indicator. The set area of the Max type alarm is marked in red colour on the analog indicator.

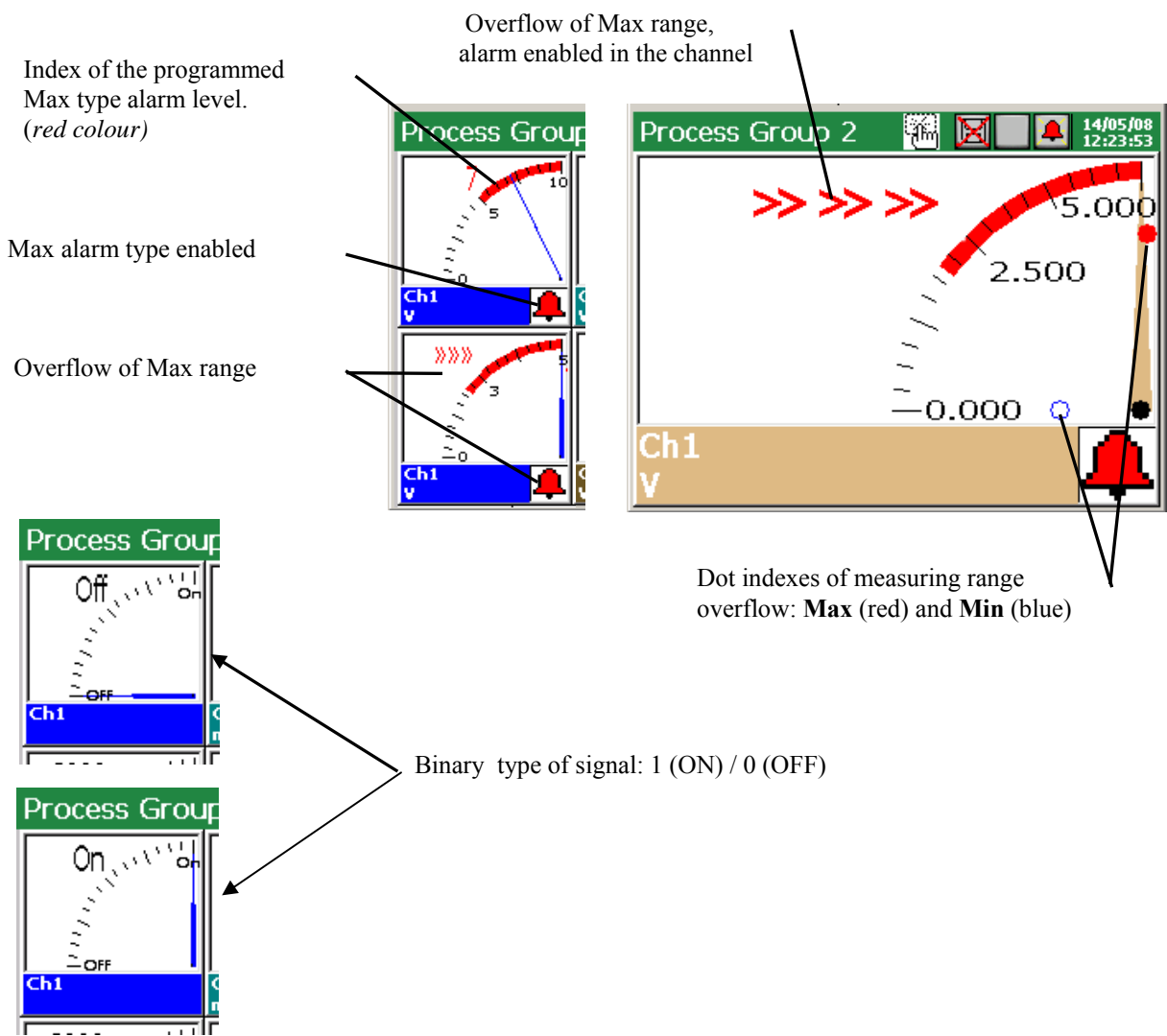

7.8.6 Statistic view of the channel group

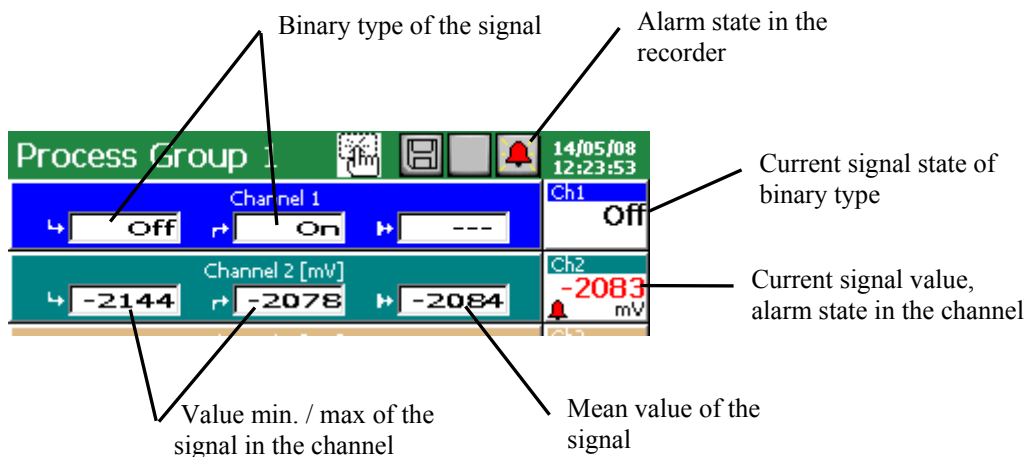

On the statistic screen following values are displayed: minimal and maximal values of the measured signal in the current session period of the recorder operation, mean values, current signal value, is signalled and the messages about the range overflow, sensor break, current alarm state, messages about the range overflow and sensor breaks, the alarm state in the recorder and the given measuring channel is also signalled.

7.8.7 Enabling/disabling the automatic screen switching in the group

During the recorder operation, types of screens programmed in the **KD8 Control Panel** → **Visualization and Archiving** → **Edited group** → **General** menu, for currently selected group of channels for presentation, are displayed.

After programming in the edition group window, in the **Common** tab, the time of changing the screen views (the screen is common for all measuring groups), one can enable or disable during the visualization, the option of automatic screen switching without the necessity to enter into the **KD8 Control Panel**.

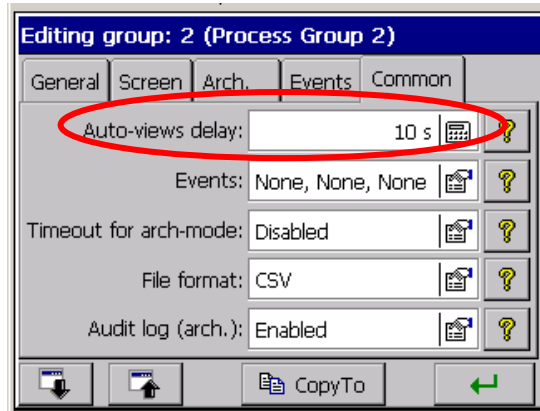

To enable the automatic switching of screens, one must mark and accept the **Auto-views turn on** function in the selection window of the **Context Menu** option.

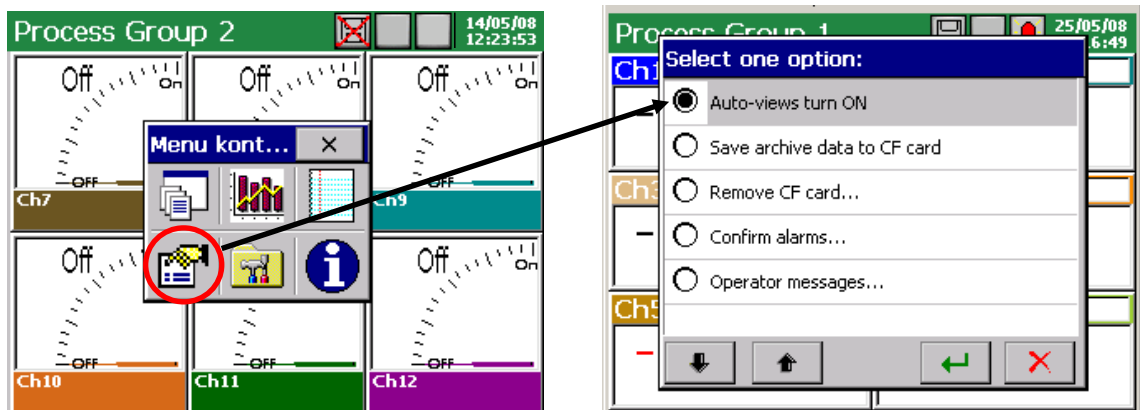

To enable the automatic switching of screens , one must mark and accept the **Auto-views turn on** function in the selection window of the **Context Menu** option.

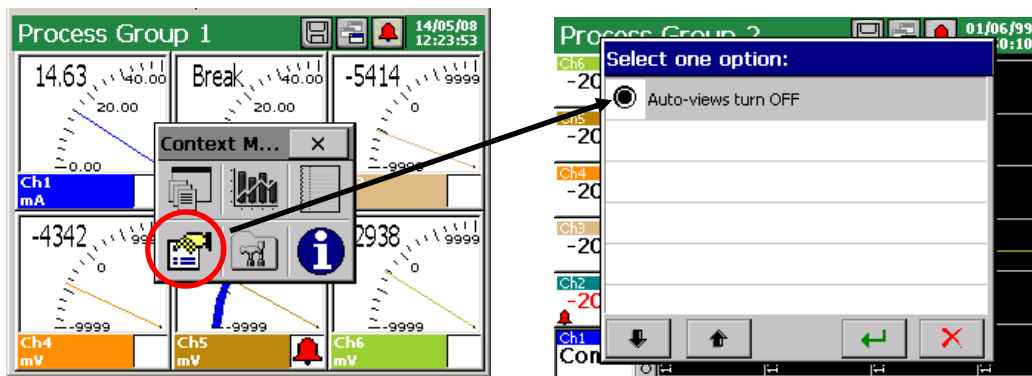

When the automatic switching is disabled, one can switch manually the screens through touching the icon of the screen selection in the **Context Menu** field, with a finger.

7.9 Zoom scale function of the signal (measuring magnifier)

The **Zoom scale** function of signals concerns and is accessible only during the display of a linear screen. The activation of this function causes the display switching of the selected channel in output range limits, into the display in limits of the set range by the parameter **Zoom scale** (see section. 7.9).

... KD8 Control Panel →Inputs:

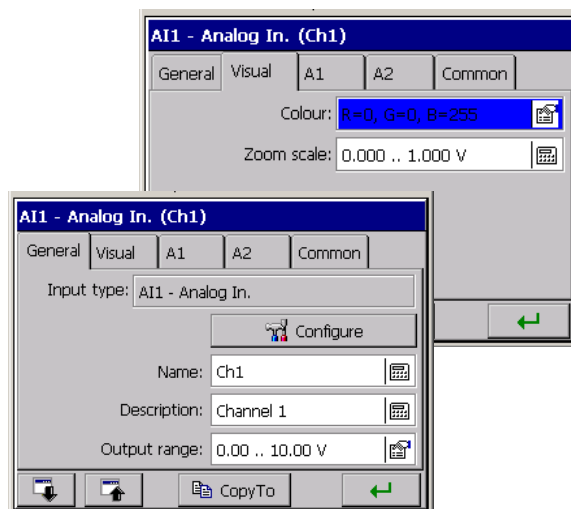

After programming the **Zoom scale function**, one can enable the display of the measurement result in limits of this parameter.

Select the **Zoom scale** function in the **Context Menu** option window, mark in the open selection window which channels this function is to concern and accept settings.

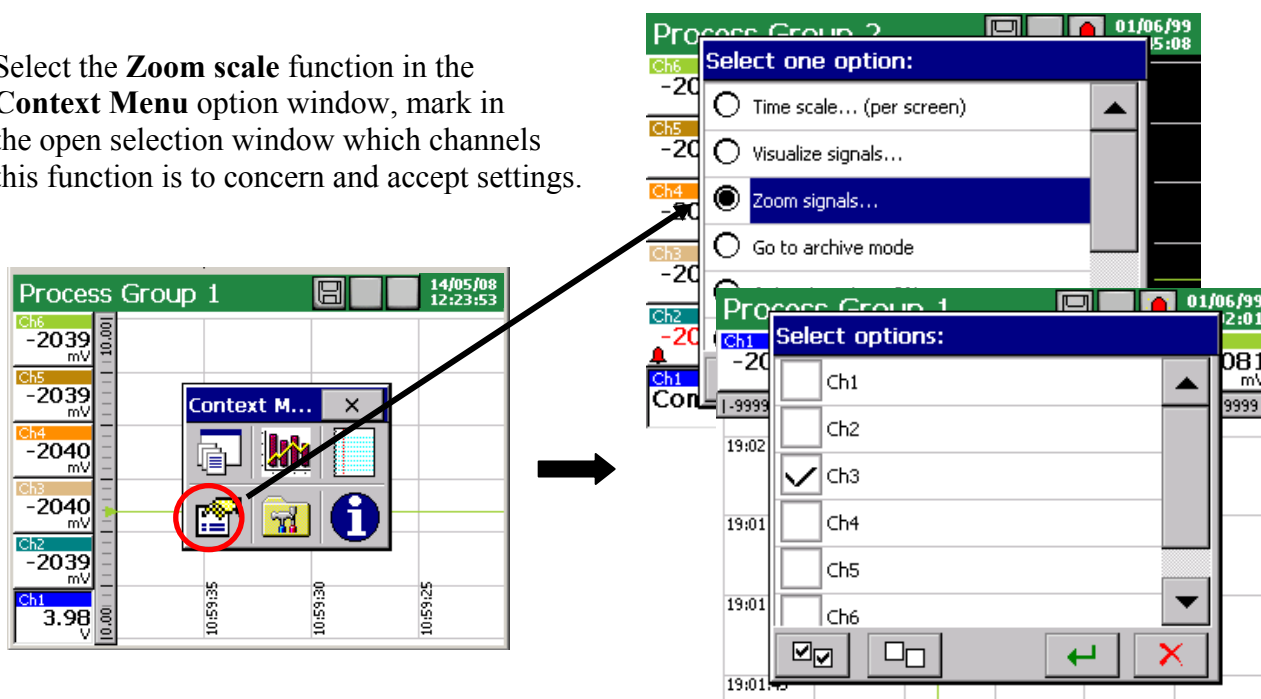

Output range of the 3 th channel

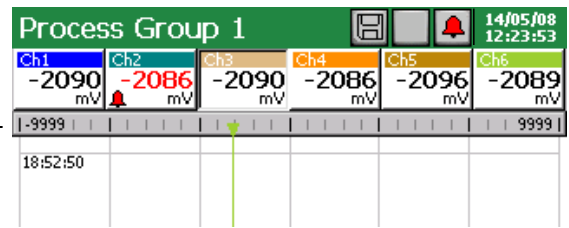

The display switching of the measurement result of selected channels follows on the view in limits defined by the parameter **Zoom scale (Channel (n) → Visual)**

3 th channel , Zoom scale is enabled

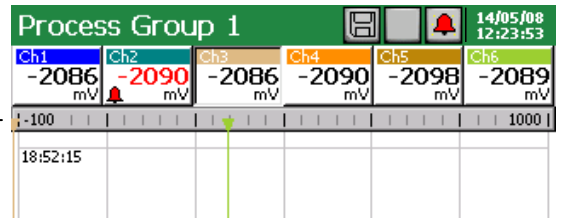

To enable the **Zoom scale** function, one must in the option window of the **Context menu**, during the display of the linear screen, select again the function **Zoom scale** for signals and in the **Select options** window, disable marked previously channels (through tapping the screen by a finger in the given channel field).

7.10 Selection of the measuring data file format (digital signature)

One can select the CSV data format or CSV with **digital signature** in the **Archive and Visualization → Edited group (n) → Common → File format** menu: CSV, CSV with digital signature, Binary with digital signature.



Data stored in binary format can be reviewed only in the **KD Archive** program (see section 9.4).

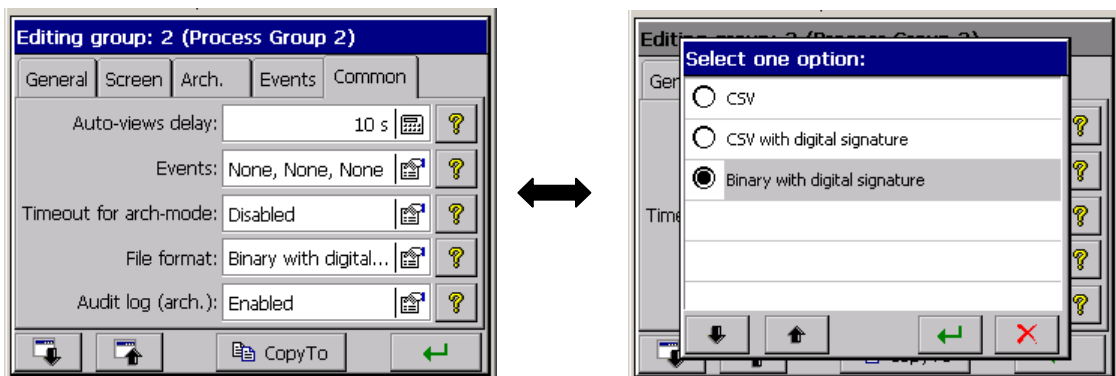

The digital signature in the “enciphered” information enabling to check the likelihood of stored data in the “CSV with digital signature” or data stored in binary format “Binary with digital signature”. After selecting the format of file storage “CSV with digital signature” at every defined number of measurement series (data block), a 128 bit “digital signature” is stored in the file. Each, even an incidental change of data will be signalled during the file check by the **KD Check** program (see section 9.3).

Since the CSV file includes the digital signature at every defined number of measurement series, the file area (range of lines from...to) will be indicated, which includes errors. Remaining data, for which the program does not ascertain data non-conformance with the signature, are credible and can be useful.

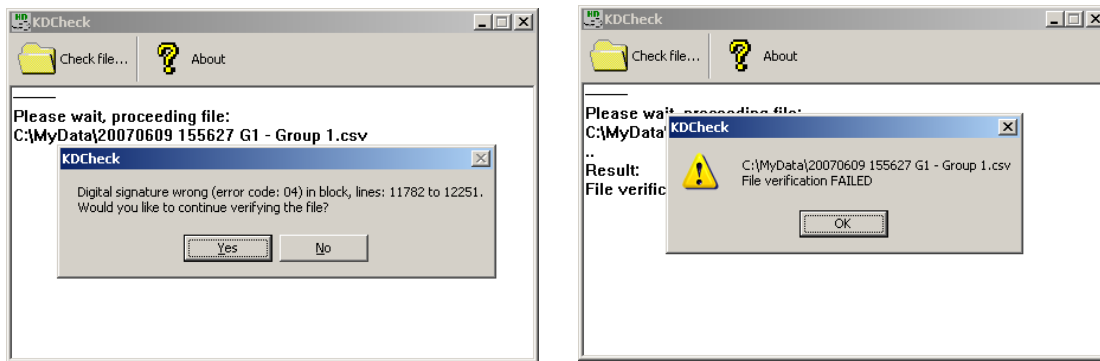

The likelihood (digital signature) of data stored in binary format is automatically checked during the review in the KD Archive program (see section 9.4.). The program shows the data area in which changes have been made.

7.11 Edition of the user's name and access password for settings

After choosing the **Security** icon in the **KD8 control panel**, one can set the user's name and the access password for recorder settings in the **Editing user window**. These settings are accessible only for one user.

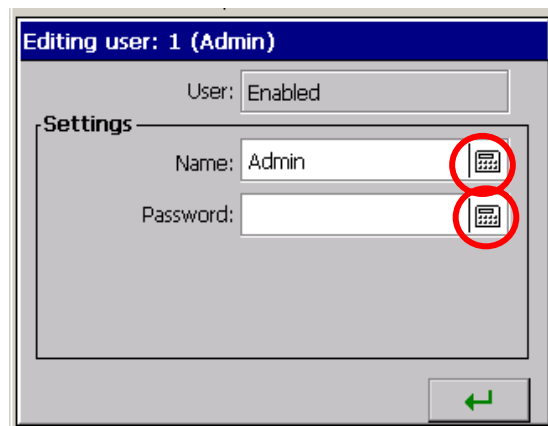

When writing the password, it is recommended to use only the Latin alphabet and numbers, without regional characters (after the language change of the recorder menu, the possibility to introduce particular characters of the password must be preserved.)

7.12 Configuration and service of event logs:

Two kinds of even logs are accessible in the KD8 recorder:

- Audit log
- Alarm log

In the **Audit log**, information concerning the recorder current service is stored: kind of event, time and date of appearance.

Audit log			
No.	Diary	Time	Date
38	Configuration Changed	06:35:26	29/08/00
37	Control Panel Closed	06:35:15	29/08/00
36	Control Panel Opened	06:34:52	29/08/00
35	Control Panel Closed	06:34:30	29/08/00
34	Storage Card Inserted	06:24:00	29/08/00
33	Storage Card Removed	06:23:15	29/08/00

Maximal capacity of the Audit log is about 900 records. **After exceeding this capacity, the log is overwritten**

Operator's information (see chapter 7.13) and information related to programmed alarm states are stored in the **Alarm log**: kind of alarm and alarm value, alarm source, time and date of appearance.

Alarm log				
No.	Alarm tag	Source	Time	Date
3	Operator Message (Ms...	-	19:55:13	30/03/08
2	Al. Rng. Off - Off (4.0...	Ch1	19:53:51	30/03/08
1	Al. Rng. Off - On (4.1...	Ch1	19:53:24	30/03/08

Maximal capacity of the Alarm log is about 700 records. **After exceeding this capacity, the log is overwritten.**

7.12.1 Review and service of event logs

After pressing the screen, during the visualization of measuring data, the **Context menu** is displayed.

The pressure of the  icon causes the view appearance of one of the event log and switching the successive views of other logs.

The pressure of the  icon during the review of one of the log causes the display, after the previous confirmation of the user's password (if it was programmed), the screen of the service option of the given log: **Reset this log / Reset all logs / Filter by groups**, filtration of data related to the selected group.

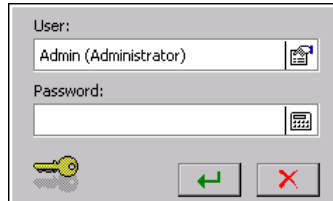

7.12.2 Programming of event logs

1. Setting of the last records number to logs (Audit and Alarm) shown on the recorder screen.

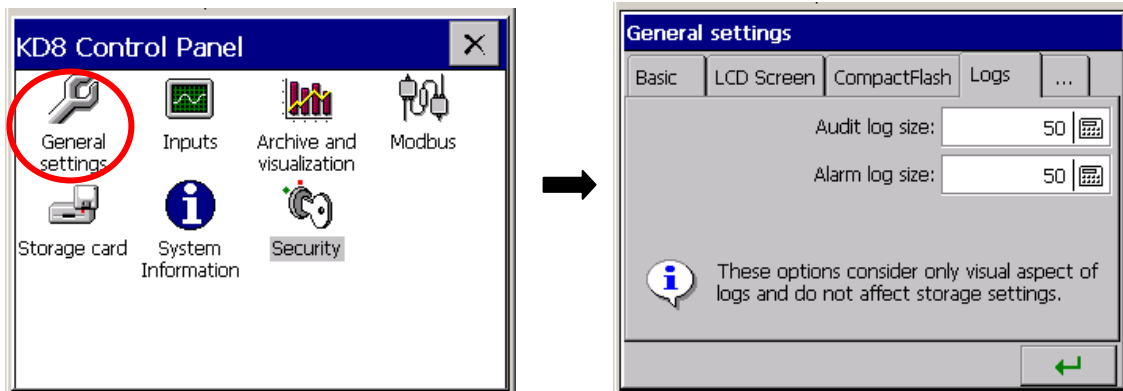

2. Setting the write of events in the alarm log (enabled/disabled) A1 /A2/ in the tab of alarms of the analog input AI 1..6.

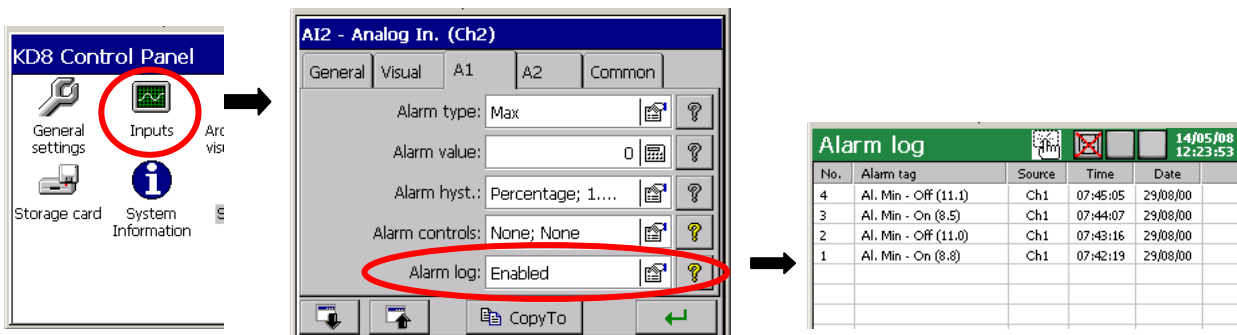

When selecting the record option: **Disabled** – messages will not appear in the log.
 When selecting the record option: **Enabled** – messages will be displayed in the log.

3. Archive settings for audit and alarm logs

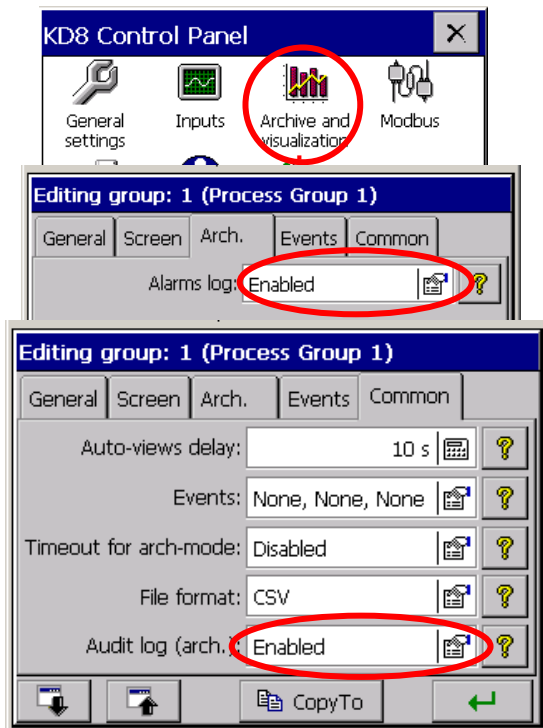

One can set the option of data archive in the tab **Arch** of the edited measuring group for the **Alarm Log**, and in the tab **Common** for the Audit Log.

Enabled - The log is displayed and stored in the memory card CF.

Disabled – The log is displayed but data from the log are not stored on the memory card.

7.13 Edition of user's messages

In the recorder configuration menu, one can program for the given measuring process up to 10 constant messages (marked preliminary as **Msg1...Msg10**), which during the work in measuring and recording mode, as the need arises, can be stored by the operator in the alarm log. The change of the message contents is possible only from the level of the recorder configuration menu.

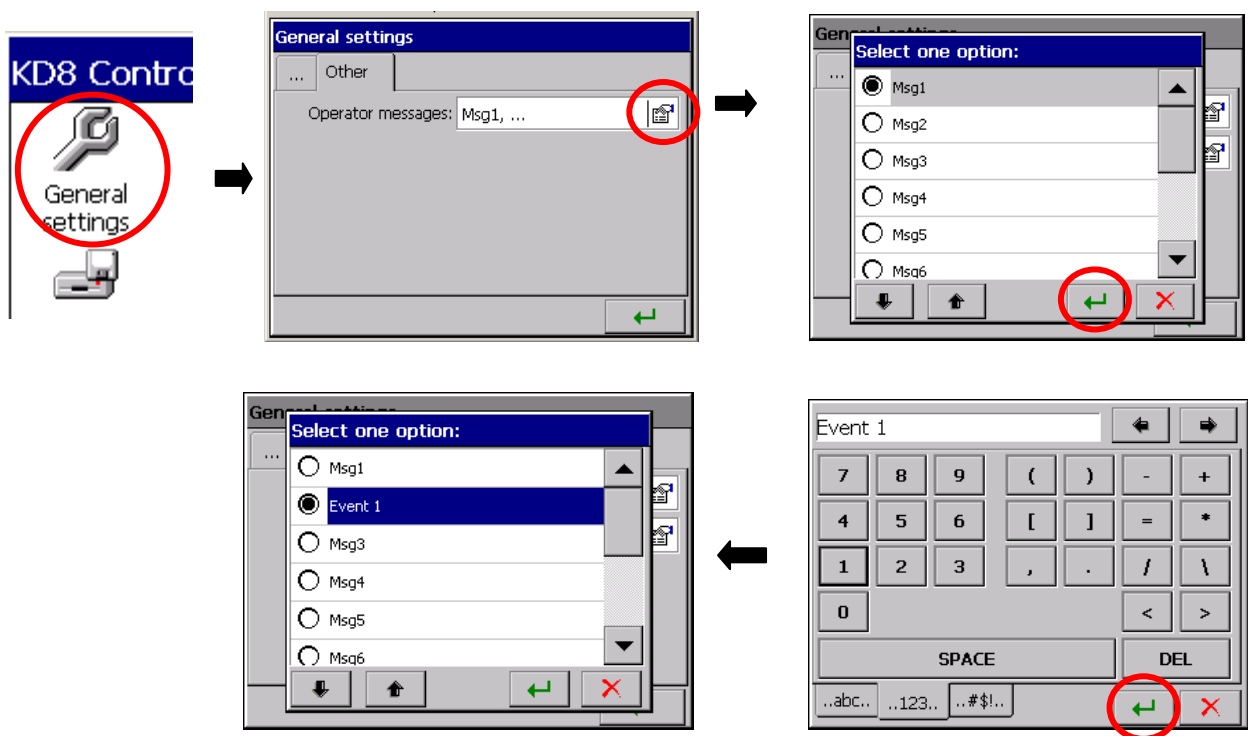

During the recorder operation in the measuring and recording mode, in the option: **Context Menu - Operator's messages – Select one option – Custom message**, one can edit a message which is currently stored in the message log without the need to transit to the recorder configuration menu.

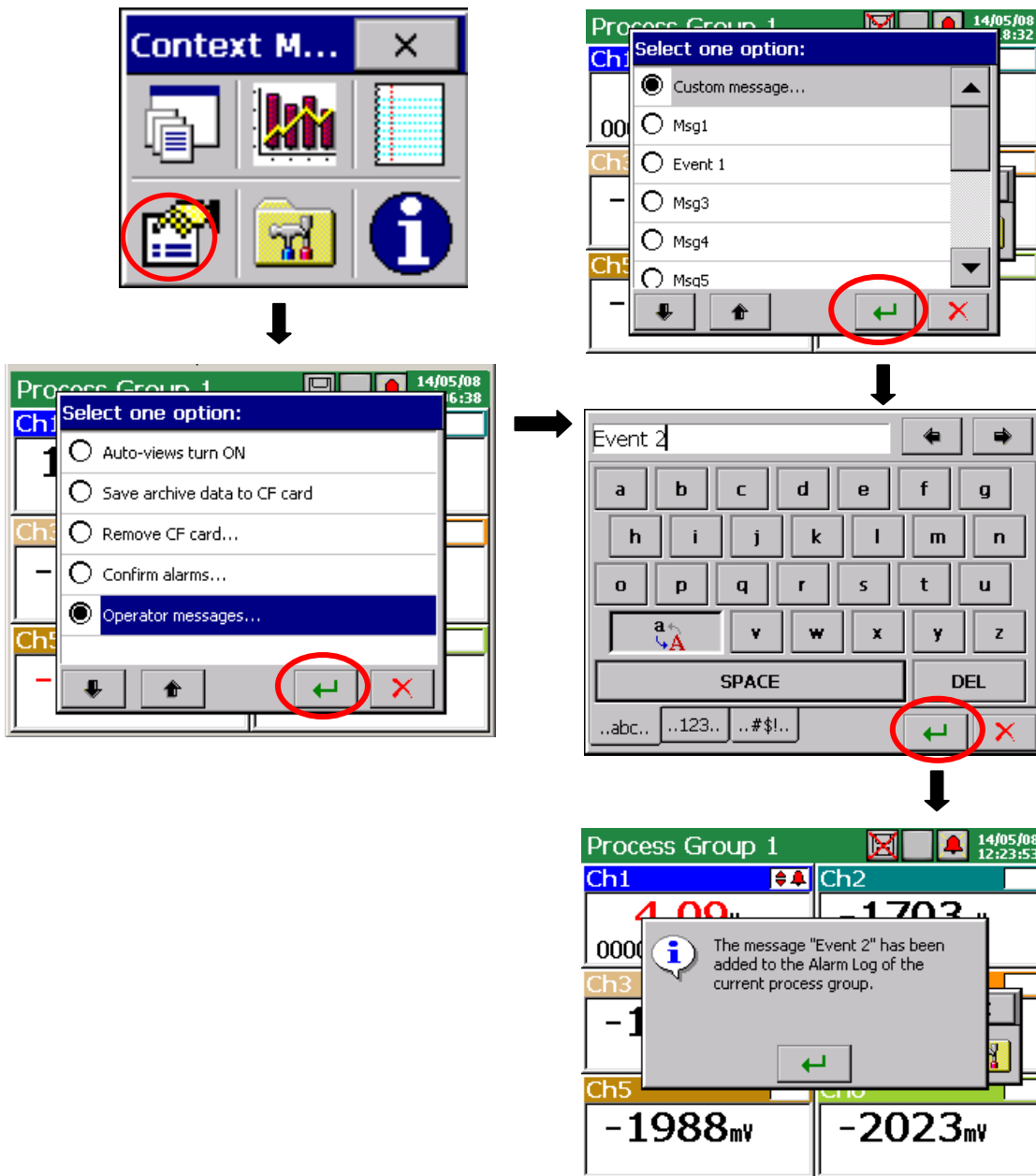

7.14 Exit from the recorder configuration

After finishing the recorder configuration, one must close **KD8 Control Panel**.

After pressing the close button from the Control Panel, the window to select the options of the configuration file storage selection is shown:

- After selecting the **Save and set configuration** button.

- When simultaneously the **Export to file** option is marked, the configuration file will be stored in the recorder memory and in the CF card, in the file with the given name in the window. The name can be changed into another, after the entry into its edition.

One can also choose any of the configuration file stored in the CF card, and under its name store a new configuration file.

- After selecting the **Leave without changes** button, changes carried out in the control panel menu are not recorded, the recorder programming state remains without changes.

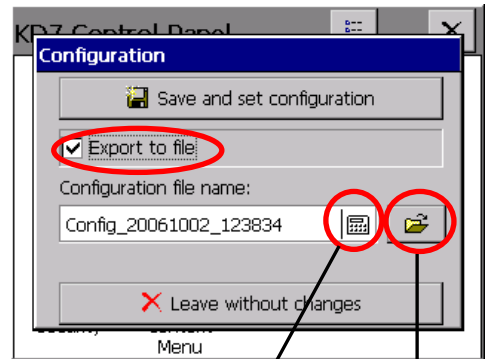
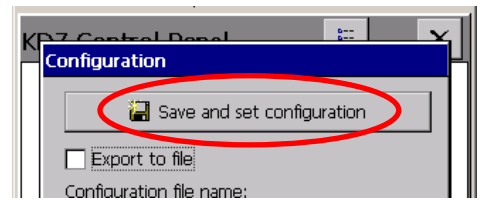
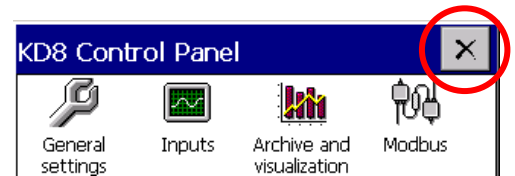

Edition of the name of configuration file

Selection of a file from stored in the CF card

Structure of the default name of the configuration file:

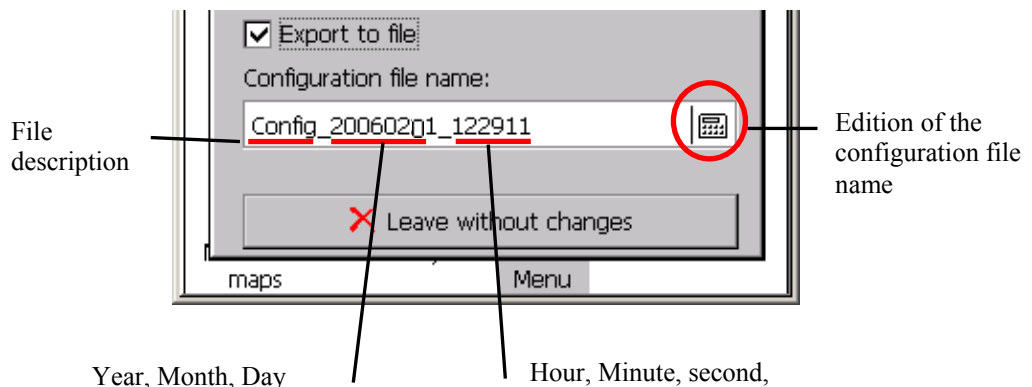

Note:

1. The configuration file is unique for the given recorder hardware configuration and cannot be transferred into another recorder with another equipment.
2. One can set in the recorder, the configuration of parameters for various technological processes and store for them proper configuration files (with proper names). Applying them, one can quickly adapt the recorder to current user's needs
3. One can also prepare configuration files in the PC computer for the given KD8 recorder by means of the program **KD8 Setup** (see section 9.2) taking advantage of another configuration file of **the same recorder**.

8. SELECTED ELEMENTS OF THE KD8 RECORDER CURRENT SERVICE

8.1 CompactFlash memory card

For the data storage in the KD8 recorder, one can use CompactFlash memory cards with a capacity from 16 MB up to 4 GB. It is recommended to use CompactFlash cards from SanDisk® company.

8.1.1 Information about the CF memory card.

After selecting in the **KD8 Control Panel** window, the  icon in the **System information – CompactFlash** tab, the information is given about the lack of the memory card in the recorder or when it is inserted into the recorder, data about the current filling state of the card, free place to store and total card capacity.

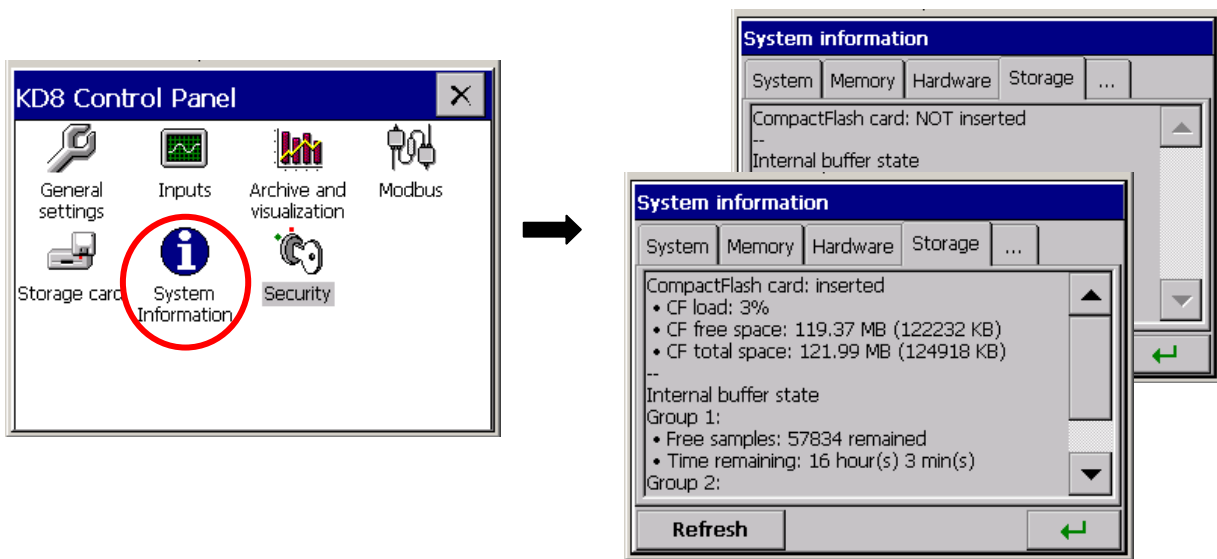

8.1.2 Formatting the CF card

After selecting the  icon in the **KD8 Control Panel**, in the **CompactFlash** tab of the **General Settings** window, one can choose options of formatting functions: **Quick format of CF card** or **Full format of CF card**.

After confirming the selection, the formatting procedure of the CompactFlash memory card will begin.

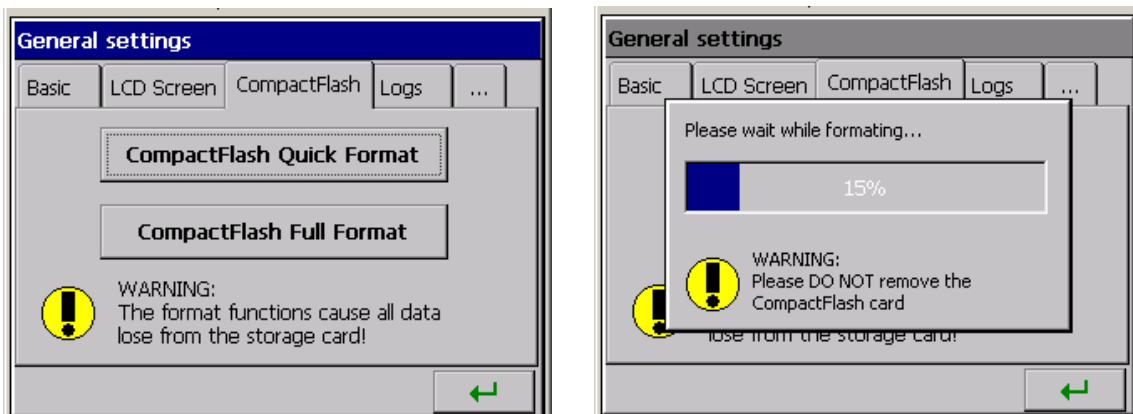

QUICK FORMAT OF THE PC CARD – deletes all files from the card, but does not scan the card for damaged sectors. Quick formatting options must be selected when the card has been already formatted and we have the certainty that it is not damaged.

FULL FORMAT OF THE CF CARD – deletes all files from the card and prepare the card to store information in it. This is followed by the check of the actual card state, physical and logic division of the card area into sectors, appropriate markings are given to them and a file system is created.

During the CF card formatting, the LED diode on the frontal plate changes its color from green into red.

8.1.3 Data storage on the CF memory card (card storage capacity)

During the recorder operation, when measuring data are stored in the recorder memory, the LED diode placed on the KD8 frontal panel, lights in green. When data from the recorder memory are reproduced on the CF card, the LED diode placed on the KD8 frontal plate changes the colour from green into red.

During data recording on the CF card, one must not pull it out from the recorder. The removal of the card can cause an irreversible loss of all data stored on the memory card. One can remove the card only after finishing the data storage on it (green colour of the LED diode).



Data are stored on the CF card in successive files, each file has a capacity allowing to open in Excel program. Files are generated separately for each channel group. When introducing changes in the recorder configuration, all data from the buffer (stored in it at the original configuration) are rewritten into the hereto open files of channel groups and new data, obtained already after introducing changes in the configuration, are stored in new open files of groups.



After exceeding 90% of the CF card capacity storage level (when the icon on the KD8 screen has the red colour).



It is recommended to transfer data from the memory card to the PC computer as fast as possible, format the card or replace for another, not recorded and formatted

- Rough time of the full CF card storage

Depending on:

- rated CF card capacity
- parameters of data storage (storage period, number of groups, number of channels in the group, data storage format: textual, binary).

Card capacity	Number of groups	Number of active channels in the group	Storage period	Time of the card filling (hours/days)			
				Textual format		Binary format	
				Hours	Days	Hours	Days
512 MB	4	6	1 s	560	22	1800	76
			5 s	2800	116	9200	380
			10 s	5600	230	18000	760
			1 min	33800	1400	110000	4600
1GB	4	6	1 s	1120	44	3600	152
			5 s	5600	230	18400	760
			10 s	11200	460	36000	1520
			1 min	67600	2800	220000	9200

After exceeding the nominal capacity of the CF card, measuring data will be stored in the KD8 buffer. During the data storage into the internal buffer, one must replace the CF card by another, formatted card. If the card is not replaced on time after filling the buffer, data will be overwritten.



The minimal working time of the recorder after which the buffer filling follows, is equal ca 8.5 hours, for 2 measuring groups of 6 channels, each which a 1 sec. storage period.

Note: Using The Program **KD Connect**, one can copy data in the PC, from the inserted CF card in the recorder and delete files.

During the recorder write, data from each measuring group are stored in the KD8 buffer.

Data are not currently recorded to the file in the CF card for the reason of possibility to a quick damage of the card. The period of data recording from the given measuring group in the CF card is the multiple of the programmed storage period for this group and can last even several months.

Considering that in the meantime, the access to the CF card with stored all current measuring data on it is needed, before its extraction from the KD8 recorder, one must start the option **Save archive data to CF card** – Then follows the rewrite of the current buffer contents on the CF card. If there is the need, these data were automatically rewritten on the CF card, e.g. in the defined interval of time then, one can apply the event **Save data on CF**.

8.1.4 Visualization of the CF card state on the screen

- Lack of CF card in the recorder



Lack of CF card in the recorder

- The CF card is inserted in the recorder



Index of CF card presence, the card is not filled.

- Exceeding of the 90% recording level of the CF card capacity



Red color, exceeding of the 90% storage level of the CF card capacity.

8.1.5 Review and erasing of files from the CF card



After selecting the Storage card icon in the **KD8 Control Panel** window, names of files stored on the CF memory card are displayed in the **Files Browser** window.

After selecting the given file and confirming the selection, this file is deleted from the CF card.

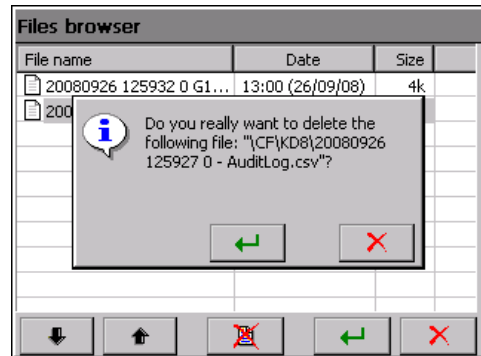
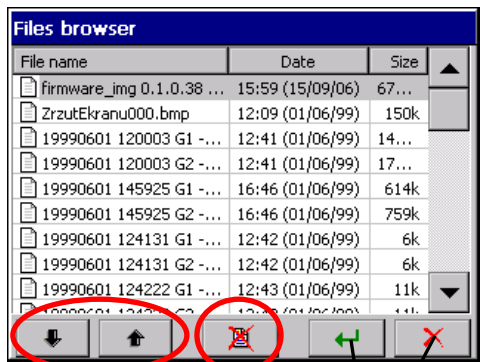

File selection

Erasing of the selected file

Exit from the menu
Return to the KD8
Control Panel

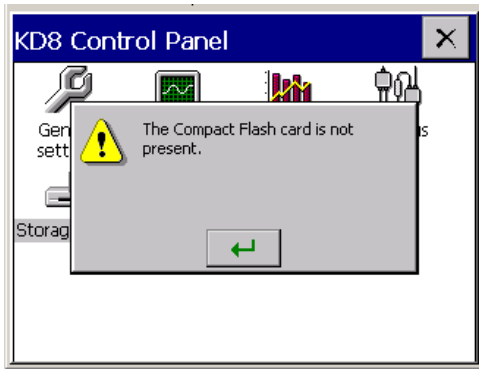

If the card is not inserted into the recorder or is not formatted, a message informing about its lack is displayed

8.1.6 Removal/replacement of the CF card, storage of archive data

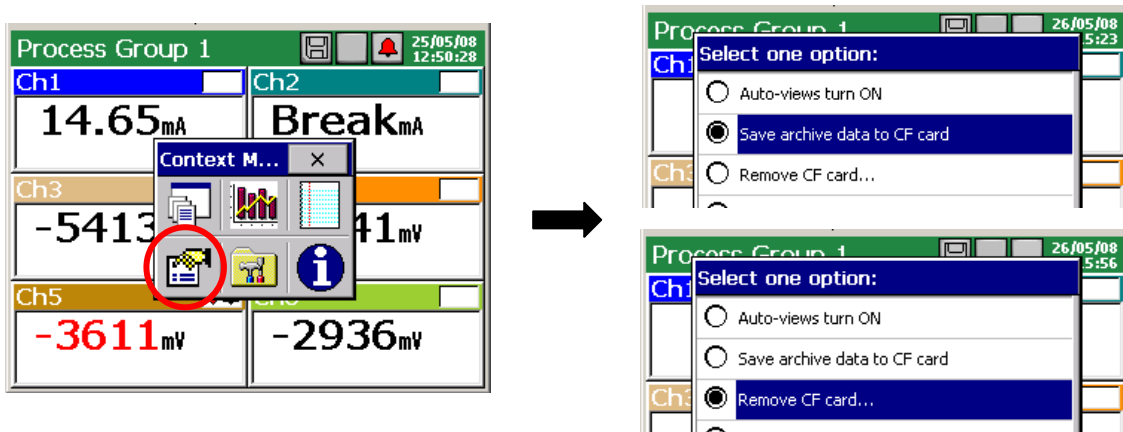

In order to take out safely the CF card from the recorder (without the loss of measuring data), one must open the **Context menu** window, (by pressing the screen with a finger), press the  icon of the option selection in it, and mark **Remove CF card** in the **Select one option** open window.

After selecting this option, the complement of data will be made automatically on the card with new data assembled (stored) in the internal buffer (it is not necessary to select the **Save archive data to CF** before choosing the **Remove CF card option**) and next, the storage on the card will be locked till the acceptance time of the displayed message. Before the message acceptance, one can replace the card for a new one.



The removal of a CF card without the previous execution of described above procedures can cause the loss of all measuring data.



The option **Save archive data to CF card** forces the rewriting of the newest data from the recorder internal memory (data buffer) on the CF card. After rewriting these archive data on the CF card, the storage to the buffer follows acc. to current settings

Taking in consideration the guaranteed life time of the CF card by its producer, it is not recommended to use too often the Archive data write on the card.



8.2 Review of archived data

The review option menu of archive data stored in the buffer is available after switching the screen view into linear in the **Context Menu**, opening the selection window of currently available options and selecting **Go to archive mode** in it.

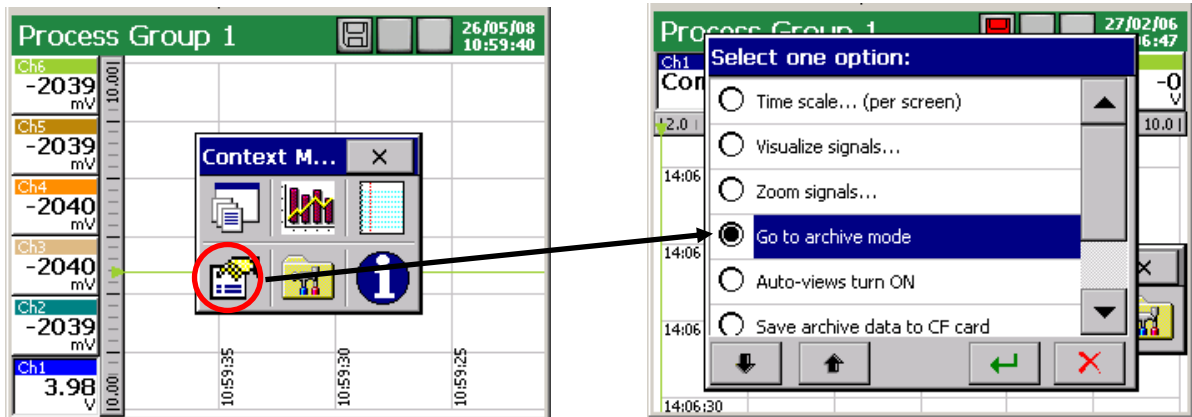

In the archive mode, after tapping the  icon or the screen in any place, the **Archive review mode** (arrows of slow and fast scrolling of the chart and the option icon for servicing archive data).

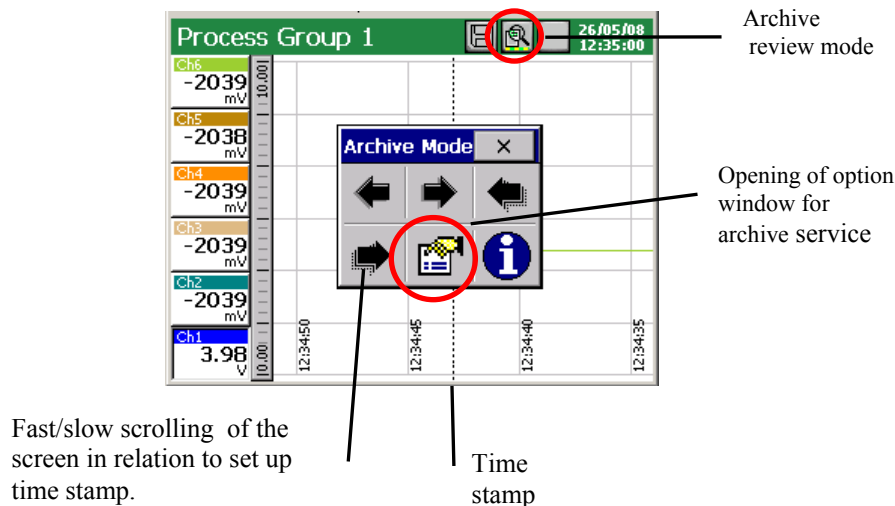

Following archive servicing options are available in the **Select one option** window:

- selection of the time scale for the archive chart,
- selection of visualized channels on the archive screen,
- enabled/disabled Zoom scale parameter (set up in the menu: ...**KD8 Control Panel**→**Inputs – Channel 1..14** →**Visual** →**Zoom scale**)
- setting of time stamp parameters on the archive screen,
- enabled/disabled sampling points (- points corresponding to the data storage time)
- end of the archive review and exit to the visualization window of current measuring data.

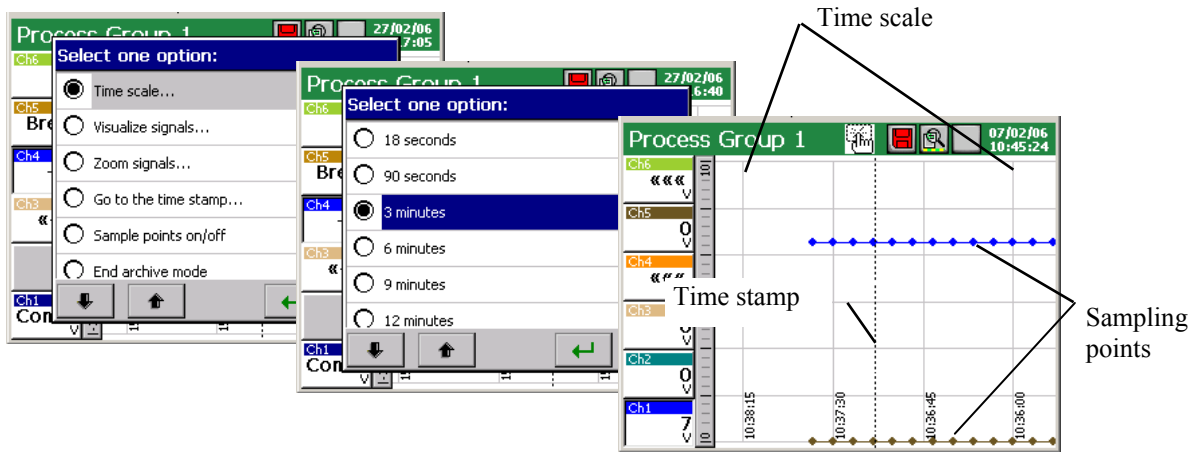

The archive service concerns only data stored in the recorder buffer till the entry moment in the function of their review. During the archive review, current measuring data are stored in the buffer and will be serviced at the renewed entry into the archive.



After changing the recorder configuration, all archive data stored in the memory buffer are erased. If they are necessary, one must rewrite them previously on the CF memory card, (see section 8.1.6.)



After storing all the buffer capacity, successive measuring data are overwritten. If all data are necessary, one must previously empty the buffer rewriting data on the CF memory card, (see section 8.1.6.)

The exit from the archive data review follows after selecting and accepting the End archive mode. A return to the current visualization of measurements follows.

8.3 Calibration of the touch screen



After selecting the **General settings** icon in the **KD8 Control Panel** window, on the **LCD screen** tab of the **General settings** window, the **Touch screen calibration** procedure is available.

One must carry out the touch screen calibration in case of incorrect reaction occurrence when pressing icons/buttons in displayed windows on the LCD screen.

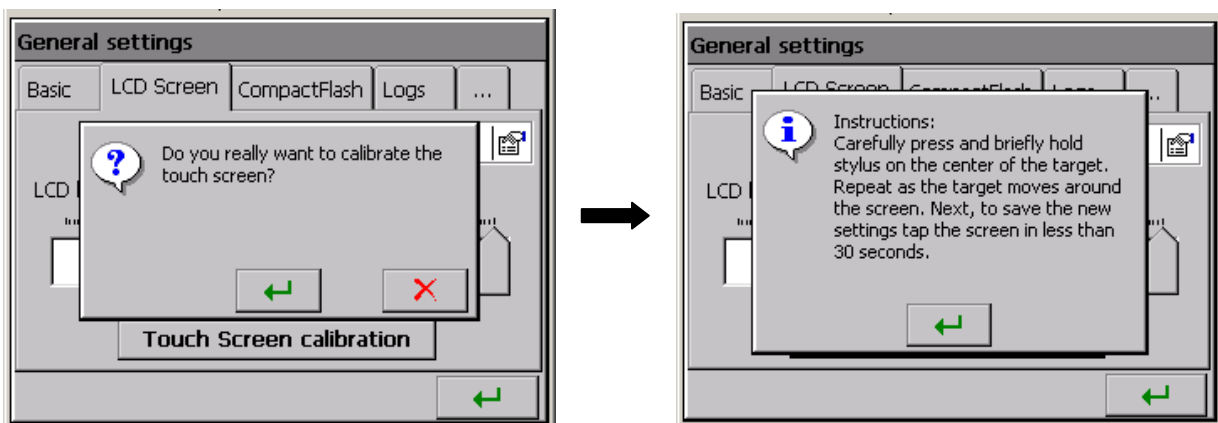

After pressing the calibration button and confirming the selection and take cognizance with the instruction, the window in which one must confirm (by pressing) successive settings of the calibration mark is opening.

To write introduced changes in the touch screen calibration, one must tap the screen (in any place) in less than 30 seconds since the setting of the mark in the exit point.

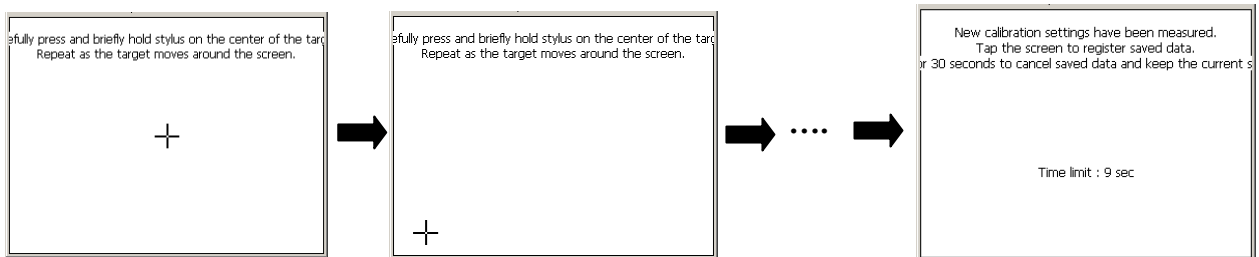

If the screen is not pressed within 30 seconds, changes in calibration will not be introduced.

8.4 Updating of the recorder software

After selecting the **System information** icon in the **Update tab** of the **KD8 Control Panel** window, the updating procedure of the KD8 recorder is available.

Taking into consideration users' opinions about the KD8 recorder, and as development works will be conducted in the company, the KD8 software will be updated. New software versions, in the form of updated files will be rendered accessible for users interested by KD8 on the page:

<http://www.lumel.com.pl>

After copying the file to the CF memory card (e.g. using the **KD Connect** program (see section 9.1.)), one can update the recorder software. In order to do that, one must carry out following operations:

a. Select the update file in the **Files Browser** window.

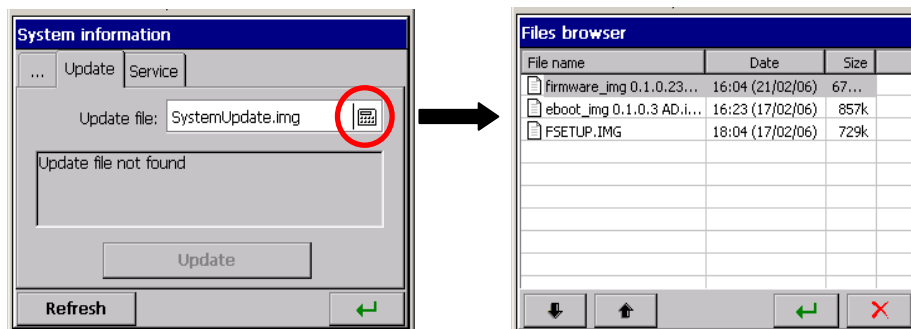

b. Accept the selection and press the update button:

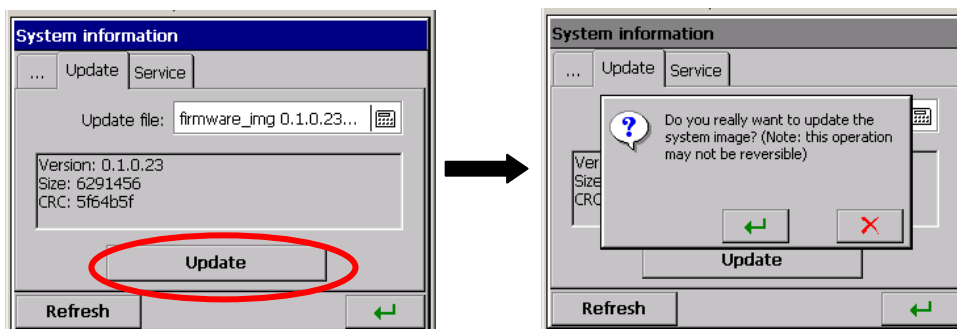

- b. After confirming the selection, the update begins and after its end, a message confirming its fulfilment is displayed.

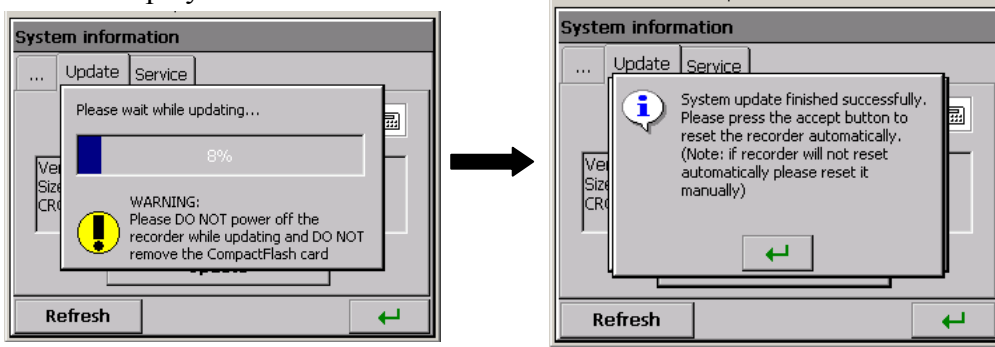

Recorder's configuration is converted automatically after updating firmware (by saving automatically to file before update and automatically restoring it from file after update).

During the system update, one **must not turn the recorder off** and **must not take the CompactFlash out.**



8.5 Service of data stored on the CF card, visualization

Measuring data, separately for each group of channels, are stored in textual files *.CSV with or without the digital signature or in binary format with digital signature (see section 8.3). To check the digital signature in the data file, the **KD Check** program is destined (see section 9.3.).

The likelihood (digital signature) of data stored in the binary format is automatically checked during their scrolling and visualization in the **KD Archive** program (see section 9.4) The limitation of the file capacity to 8 MB enables the direct review and visualization of data stored in the textual format *.CSV, e.g. in the Excel program or OpenOffice Calc.

	A	B	C	D	E	F	G	
1	Time	Ch1	Ch2	Ch3	Ch4	Ch5	Ch6	Digital Sign
2	07-06-09 15:58	27,2	27	27,1	27	26,9	26,8	
3	07-06-09 15:58	27,2	27	27	27	26,9	26,8	
4	07-06-09 15:58	27,2	27	27	27	26,9	26,8	
5	07-06-09 15:58	27,2	27,1	27,1	27	26,9	26,8	
6	07-06-09 15:58	27,2	27,1	27,1	27	26,9	26,8	
7	07-06-09 15:58	27,3	27,1	27,1	27	26,9	26,8	
8	07-06-09 15:58	27,3	27,1	27,1	27	26,9	26,8	
9	07-06-09 15:58	27,2	27,1	27,1	27	26,9	26,8	
10	07-06-09 15:58	27,2	27,1	27,1	27	26,9	26,8	

ID of the logic channel in the group G1

Data from the memory card can be copied to a PC computer using the memory card reader servicing cards of CompactFlash type or taking advantage from features of the **KD Connect** program added to each delivered recorder.

The **KD Connect** program is destined for the communication between the PC computer and the **KD-Series** recorder by means of the USB interface. It enables to carry out the following operations:

- 1) copying files from the CompactFlash card, directly from the recorder on the PC computer (e.g. data files, screen dumps)
- 2) uploading of files from the PC computer on the CompactFlash card in the recorder (e.g. file with the updated KD8 software)

- 3) removal of accumulated files from the CompactFlash card in the recorder,
- 4) collection of current systemic information of the KD8 recorder (among others: system version, current configuration, level of CompactFlash card fulfilling)

The **KD8 Setup** program (see section 9.2) enables to prepare in the PC a configuration file for the KD8 recorder. The appearance and service of the **KD8 Setup** program are the same as to the recorder service menu described in the user's manual. But one must take notice of occurring differences:

- To service the **KD8 Setup** program, the mouse and computer keyboard are used.
- Dialogues of file selection allow to review the contents of computer disks.
- The language of the **KD8 Setup** program is compatible with the language of the last edited configuration.
- The appearance of dialogue windows highly depends on the system personalization (as e.g.: the size of the system font).

The result of work with the KD8 Setup program is the configuration file for a recorder of a defined hardware configuration (kind and number of cards, settlement of slots).

9. PROGRAMS ON PC

9.1 KD Connect Program

The **KDConnect** program is destined for the communication between the PC computer and the **KD-Series** recorders by means of the USB interface.

The **KD Connect** program enables to carry out the following operations:

- copying of files from the CompactFlash card, directly from the recorder into the PC computer (e.g. data files, screen dumps),
- uploading of files from the PC computer into the CompactFlash card in the recorder (e.g. a file with the KD8 software update)
- deletion of stored files in the recorder CompactFlash,
- sampling of current systemic information of the KD8 recorder (among others, system version, current configuration, degree of the CompactFlash filling)

9.1.1 Installation of drivers for the KD8 recorder

One must install the driver in order to see correctly the KD8 touch screen recorder under the operating system MS Windows:

1. After connecting the recorder with the USB cable (delivered in the KD8 accessory set) to the free port in the computer, information about the detection of a new hardware appears in the computer.
Next, the creator to detect the new hardware will be started.
2. Please insert the CD disk delivered with the KD8 recorder into the CD-ROM drive.
3. (This point concerns the XP system with SP2) When asking: "**Can the Windows system be connected with the WEB page**" mark the option "**No, not this time**"
4. The dialogue "Creator of hardware updating" appears.
5. Select the option "**Install the software automatically**" and click "**Next**".
6. Select the found driver from the list and press "**Next**" to install the driver by the creator. When the creator inform about the lack of driver compatibility tests with Windows, answer "**Continue...**". Next, click the button "**End**".

After the correct driver installation (a restart of the system is not required) one can transit to the installation of the program delivered with the KD8 screen recorder.

Select the directory with the **KDConnect** program on the accompanied CD and start the **KDConnect_install.exe** program. The program installation creator will be started. One must proceed in compliance with instructions displayed on the screen.

9.1.2 Installation of the KD Connect program

Program requirements:

- Operating system: MS Windows 2000 or a newest one,
- Installed dedicated drivers for KD8 recorders,
- About 3 MB of free capacity in the hard disk,
- Other requirements equal to requirements makes demands of the operating systems

The program installation is typical for applications destined for the MS Windows environment. The program installation is in the annexed CD disk, in the “**KD Connect**” directory.

To begin the installation, one must start the **Setup** program being in the indicated directory.

After selecting the language used during the installation, the window of the installation creation is opening.



Next, proceed acc. to appearing messages on the screen.

After carrying out the installation, a window appears informing about its end.



9.1.3 Program service

- **Main application window**

The view of the main application window when the KD8 recorder is not connected (through the USB interface) to the PC computer, informs about this message in the information window and disabled icons on the toolbar

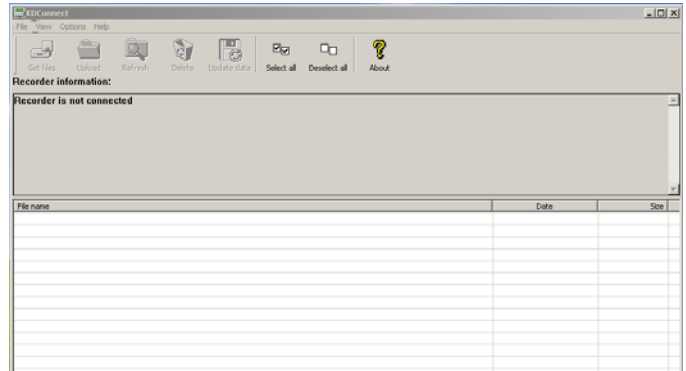

View on the main application window with the connected KD8 recorder to the PC.

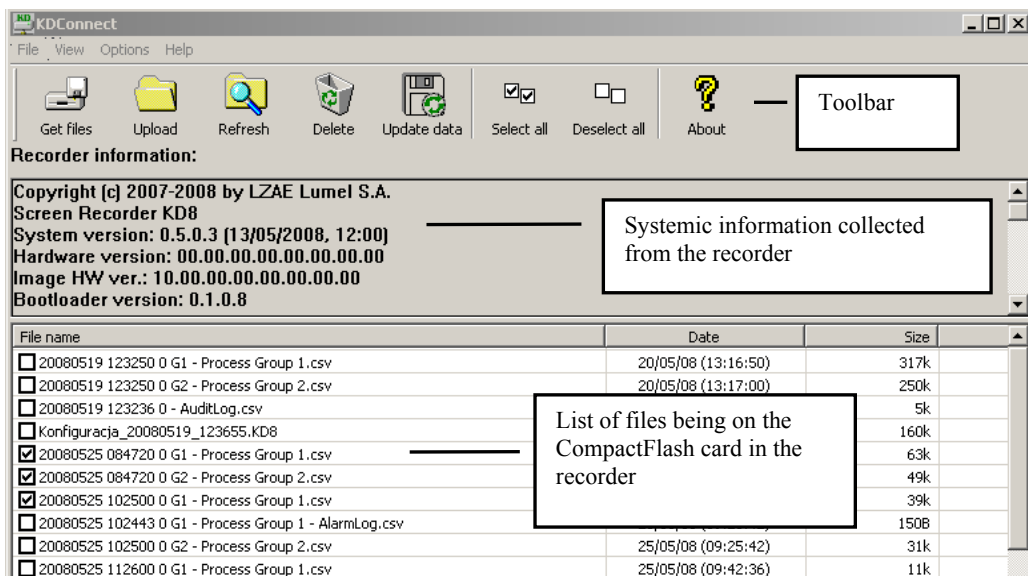









- **Toolbar**

The application toolbar is situated on the upper part of the window and has the following appearance:



This toolbar allows to a quick access to the most important program options. Explanations of symbols are given below.

	Call of the collection option of marked files from the recorder into the PC computer.
	Upload the file from the PC computer into the CompactFlash installed in the recorder.
	Renewed collection of basic data from the recorder (systemic information and the list of files).
	Removal of marked files from the CompactFlash card installed in the recorder.
	Storage of all current measuring data from the buffer into CF
	Selects all files on the list of files
	Deselects all files on the list of files
	Shows the program information window.

- **Program settings (Application menu → Options → Settings...)**

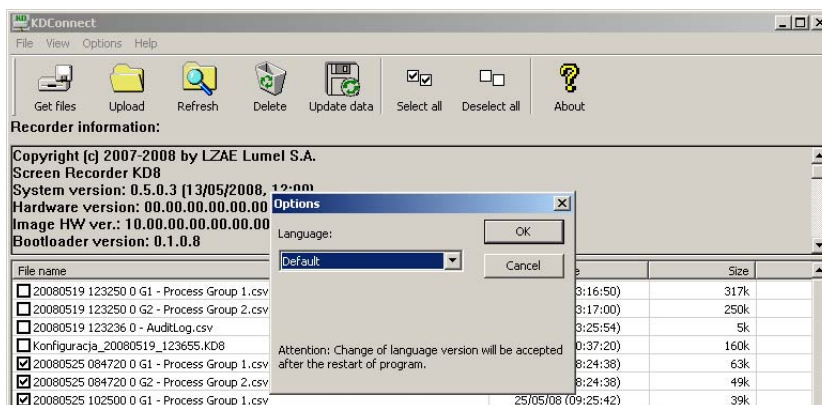

Program options allow to change the application language. The selection of the language as **Default** means the application start in the language consistent with the language of the operating system if it is serviced by this program. Otherwise, the language of the application is English.

- **Collecting function of files from the recorder (Application menu → files → Collect marked files...)**

To collect defined files from the recorder, one must mark them on the list of files (in the square, next to the file name, the tick of marking appears).

Marked file for collecting

System version: 0.1.0.23 [21/02/2006, 14:54]	
Bootloader version: 0.1.0.2	
File name	
<input type="checkbox"/>	firmware_img 0.1.0.23.img
<input checked="" type="checkbox"/>	20060224 124428 G1 - Process Group 1.csv
<input checked="" type="checkbox"/>	20060221 161130 G2 - Process Group 2.csv
<input type="checkbox"/>	eboot_img 0.1.0.3 AD.img

Next, one must call the option **Get selected files....** from the application menu.

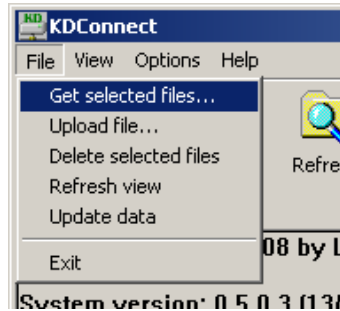

or from the toolbar:



The window appears with the selection of the path for files recording in the PC computer:

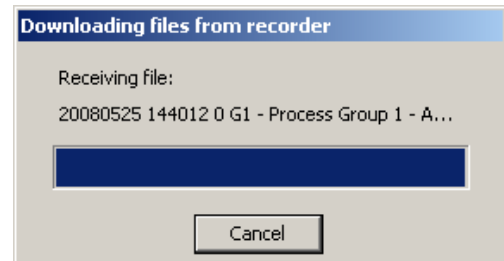
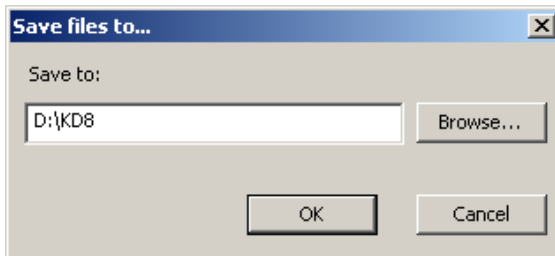

After confirming the in-coming path, the copying of files begins.

To collect the defined file and start it with a default servicing program, one can click twice on the file name.

- **The function of uploading files to the recorder (Application menu → Files → Upload files ...) .**

The option allows to upload any file from the PC computer into the CompactFlash card installed in the recorder. The command can be selected from the application menu.

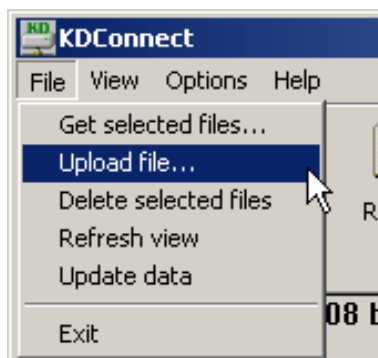

or from the toolbar:



The standard window for file selection will appear:

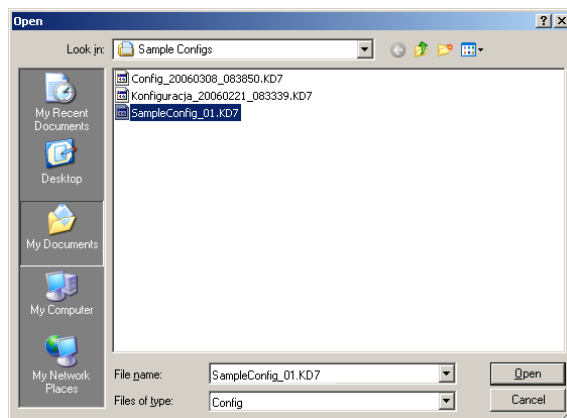

After selecting, the data transmission begins.

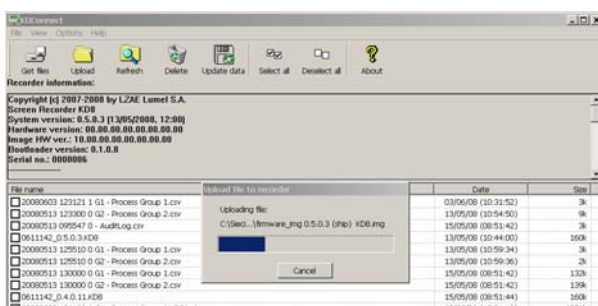

Note: The function is also serviced through the mechanism “Drag&Drop”. For this aim, one must drag the selected file, e.g. from the Explorer Windows on the area of the file lists of the **KD Connect** program.

- **Data erase from the recorder (Application menu → Files → Delete selected files)**
To erase selected files from the CompactFlash card situated in the recorder, one must mark them previously (a tick mark appears in the square next to the file name):

Marked files to erase

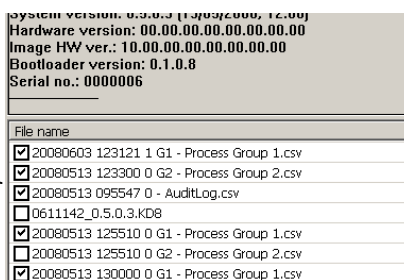

Next, one must choose the option **Delete selected files** from the application menu.

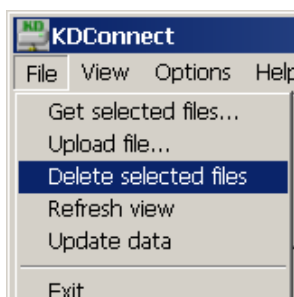

or the icon from the toolbar:



After selecting the command, the dialogue informing about the operation progress and its end will be displayed.

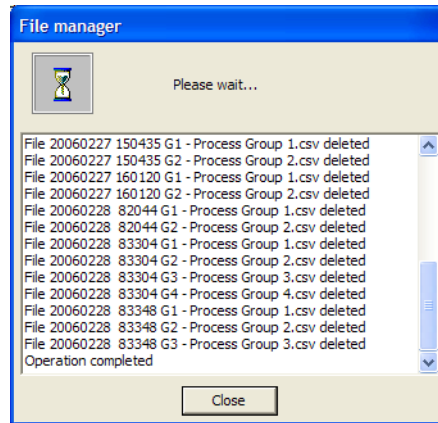

9.2 KD8 Setup program

KD8 Setup is a program enabling to prepare a configuration file in the PC computer for the KD8 recorder.

After recopying the configuration on the CF memory card, it can be used for reprogramming of settings in the given KD8 recorder.

9.2.1 Installation

The software installation is typical for application destined for the MS Windows environment. The installation program is situated on the annexed CD disk to the recorder, in the “**KD8 Setup**” directory. To begin the program installation, one must start the installation program **KD8Setup_install.exe** being in the indicated directory.

Next, one must proceed according to messages appearing on the screen (like in the description of the **KD8 Connect** program installation).

9.2.2 Program service

The appearance and service of the **KD8 Setup** program is the same from the service menu of the recorder described in the user’s manual. However, one must observe occurring differences:

- For servicing the **KD8 Setup** program, the mouse and the PC computer keypad are used,
- Dialogues of file selection allow to browse the contents of computer disks,
- The language of the **KD8 Setup** program is in compliance with the language of lately edited configuration,
- The appearance of dialogue windows depends notably on the system personalization (e.g. the size of the system fonts)

The result of work with the **KD8 Setup** program is the configuration file for the recorder with a defined hardware configuration (kinds and number of cards, settlement of slots).

The generated configuration file can be also installed in the KD8 recorder as an another configuration then defined in the KD8 Setup program, then during the installation, it will be connected to the current configuration of the recorder.

- **On the KD8 recorder side**

- a. Record the current KD8 configuration file on the CompactFlash card
Mark the option **Export to file** in the output dialogue from the **KD8 Control Panel** and give the appropriate name to the file (or remain the proposed name). Next, store the configuration. (option: **Save and set configuration**)

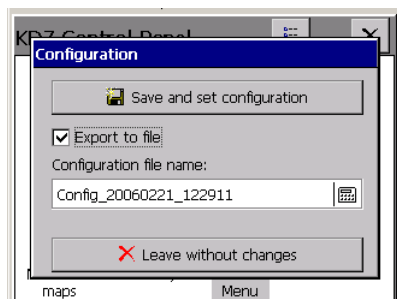

- b. Upload the recorded configuration file to the PC computer by means of one of the recorder communication interfaces. One can do this by means of the USB interface program and the **KD8 Connect** program (see section 9) or through the Ethernet interface.

- **On the PC computer side**

- a. Start the **KD8 Setup** program, call the context menu (tap on the area of the recorder screen), and next press the input icon in order to configure the recorder.

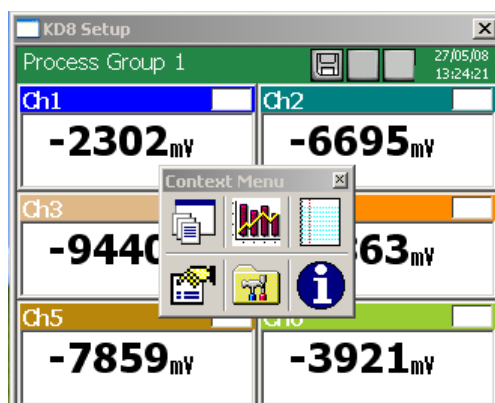

- b. The logging dialogue appears. One must transit into the configuration dialogue.

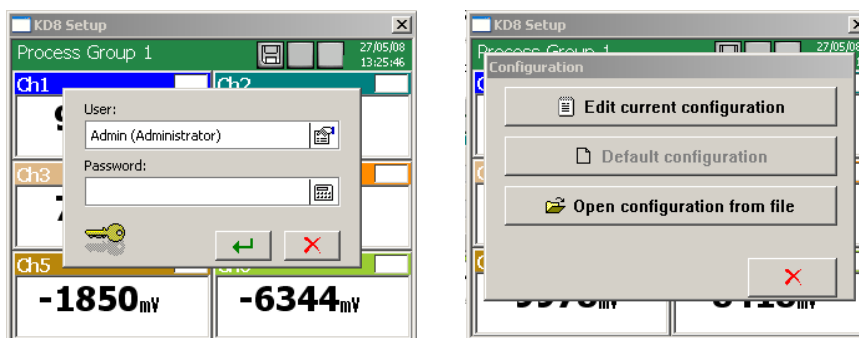

- c. During the first configuration, one can select the only available option: **Open configuration from file**. The standard dialogue of the Windows system appears to open files. One must select the previously saved configuration file.

d. After reading the configuration file in, the transition to the **KD8 Control Panel** follows. At this moment, one can perform changes in the recorder configuration.

e. After finishing configuration operations, one must give a name to the new configuration file and save it in the PC computer disk (selecting the appropriate name for the configuration and in-coming folder).

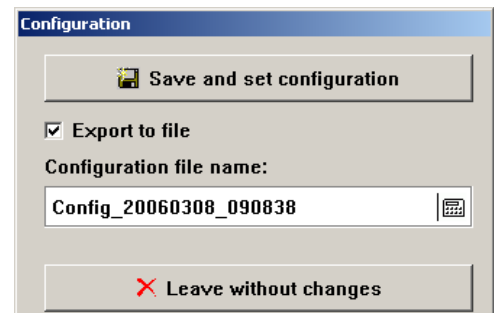

f. Next, upload configuration file from the PC computer to the recorder. One can do that, e.g. by means of the **KD8 Connect**. program or through the CompactFlash card. (to save the file in the CF card, one can use a standard commercial reader of memory card).

- **On the KD8 recorder side**

- a. On can get the saved configuration in KD8 from the CF card and open after transiting to the **KD8 Control Panel – Configuration**, option: **Open configuration from file**.
- b. After reading the configuration, it is edited on the recorder screen.

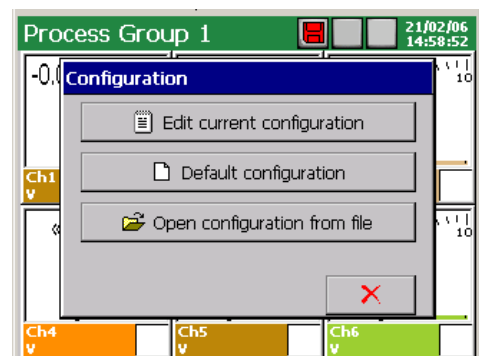

During the first run of the application you will be asked for a License Key File. Please follow the messages that appear on the screen. If you do not have the license key the application will run in the demo mode.

9.3 KD Check program

The KDCheck program is destined for the verification of file correctness with measuring data saved in the CSV with digital signature format (see section 8.3.) The program installation is typical for application destined for the MS Windows environment.

The installation program is situated on the annexed CD disk to the delivered recorder. To begin the program installation, one must start the **KDCheck_install.exe** installation program. The creator of program installation will start. Please follow the instruction displayed on the screen.

Selection and file check



Check result:
Correct verification
of the file

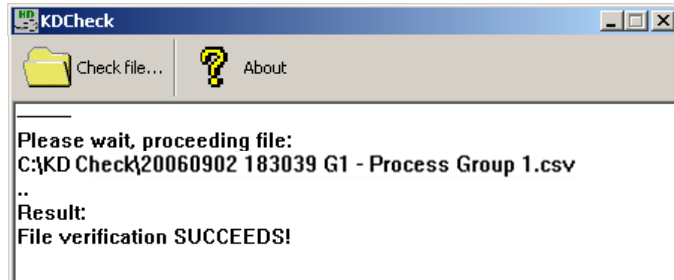

Information about the block in
which we state discordance of
the digital signature with saved
date

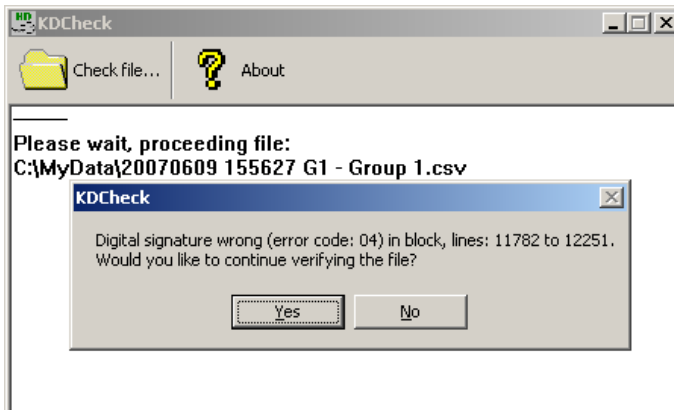

Check result:
Wrong verification of the
file.

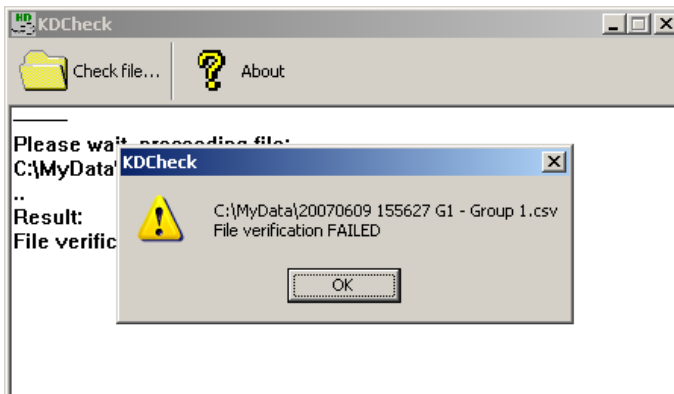

9.4. KD Archive program

The **KD Archive** program is destined for visualization and analysis of archived measuring data stored in binary format in the CF card.

The software installation is typical for applications dedicated for the MS Windows environment (MS Windows XP or a newest one).

The installation program and service manual of the **KD Archive** program are on the accompanied CD to the recorder. In order to start the program installation, one must start the installation program **KDArchive_install.exe**. The creator of the software installation will be started. One must proceed according to instructions displayed on the screen.

During the first run of the application you will be asked for the License Key File. Please follow the messages that appear on the screen.

10. TECHNICAL DATA

▪ Programmable measuring system:

- number of measuring channels: 3 or 6
- input resistance: > 10 MΩ (U, TC); =100 Ω (I)
- sampling rate: 350 ms (for 1 measuring place)
- measuring accuracy: according to the table 1
- additional measuring error with the automatic temperature compensation of the thermocouple reference cold junctions: ≤ 1°C
- isolation between measuring places: 100 V d.c.
- isolation measuring place-housing: 500 V d.c.

Measuring ranges (universal measuring inputs) / Measuring accuracy:

Table 1

Input signal	Signal symbol in the menu	Measuring range / Measuring accuracy (%)		Minimal sub-range / Measuring accuracy (%)	
		3	4	5	6
Voltage	mV	0... ± 9999 mV	0.15	5 mV	0.25
Current	mA	0...±20 mA	0.15	1 mA	0.25
Thermocouple (TC):					
J (Fe - CuNi) ¹⁾	TC J	-200...1200 °C	0.1	100 °C	1
K (NiCr - NiAl) ¹⁾	TC K	- 200...1370 °C	0.1	130 °C	0.7
N (NiCrSi - Ni Si) ¹⁾	TC N	-200...1300 °C	0.1	200 °C	0.5
E (NiCr-CuNi) ¹⁾	TC E	-200...1000 °C	0.1	100 °C	1
R (PtRh13 - Pt) ¹⁾	TC R	0...1760 °C	0.2	540 °C	0.3
S (PtRh10 - Pt) ¹⁾	TC S	0...1760 °C	0.2	570 °C	0.3
T (Cu- CuNi) ¹⁾	TC T	-200...400 °C	0.1	110 °C	0.9
B (PtRh30 - PtRh6) ¹⁾	TC B	400...1820 °C	0.2	1000 °C	0.3
L (GOST) ²⁾	TC TXK (GOST)	-200 800	0.1	90 °C	0.3
K (GOST) ²⁾	TC TXA (GOST)	-200 1370	0.1	130 °C	0.7
Resist. thermometer (RTD):					
Pt 100 ³⁾	Pt 100	- 200...850 °C	0.15	50 °C	0.25
Pt 500 ³⁾	Pt 500	- 200...850 °C	0.3		0.5
Pt 1000 ³⁾	Pt 1000	- 200...850 °C	0.3		0.5
Ni 100 ³⁾	Ni 100	- 60...180 °C	0.15		0.25
Cu 100 ³⁾	Cu 100	-50...180 °C	0.15		0.25
GR.21 (GOST'78) ⁴⁾	GR.21 (GOST'78)	-260...1100 °C	0.15		0.25
GR.21 (GOST'94) ⁵⁾	GR.21 (GOST'94)	-260...1100 °C	0.15		0.25
50P (GOST'78) ⁴⁾	50P (GOST'78)	-260...1100 °C	0.15		0.25
50P (GOST'94) ⁵⁾	50P (GOST'94)	-260...1100 °C	0.15		0.25
100P (GOST'78) ⁴⁾	100P (GOST'78)	-260...1100 °C	0.15		0.25
100P (GOST'94) ⁵⁾	100P (GOST'94)	-200...200°C	0.15		0.25
50M (GOST'78) ⁴⁾	50M (GOST'78)	-200...200°C	0.15		0.25
50M (GOST'94) ⁵⁾	50M (GOST'94)	-200...200°C	0.15		0.25
100M (GOST'78) ⁴⁾	100M (GOST'78)	-200...200°C	0.15		0.25
100M (GOST'94) ⁵⁾	100M (GOST'94)	-200...200°C	0.15		0.25
Potentiometric transmitter	Pot. Trans.	50...2000 Ω	0.15		100 Ω
Resistance transmitter	Res. Trans.	0...2000 Ω	0.15	100 Ω	0.25

1) Characteristics of thermocouples: acc. to EN 60584-1

2) Characteristics of thermocouples: acc. to GOST R 8.585-2001

3) Characteristics of resistance thermometers: acc. to EN 60751+A2

4) Characteristics of resistance thermometers: acc. to GOST 6651-78

5) Characteristics of resistance thermometers: acc. to GOST 6651-94

Rated operating conditions and additional errors:

Table 2

Influencing quantity or influencing factor	Value, range or reference conditions	Number of the range type	Measurement additional errors or attenuation
1	2	3	4
Ambient temperature	0...23...50°C	01...13	0.25 / 10°C
Supply voltage	90...230...253 V	01...13	0.2 % × range
External magnetic field	0...400 A/m	01...13	0.1 % × range
Resistance of the external measuring circuits	0...1 kΩ	01	< 50 μV / 1 kΩ
	-	02	-
	0...50 Ω / lead ¹⁾	03, 04	< 0.05 Ω
	0...100 Ω	05...11	< 5.0 μV / 100 Ω
	0...50 Ω / lead ¹⁾	12, 13	< 0.2 °C
Interferences by the serial component: 50 and 100 Hz for a 50 Hz supply network 60 and 120 Hz for a 50Hz supply network	Up to 2.5 x max value in the programmed range For a measured voltage above 5 V it diminishes to the value x 1.2, at 10 V	01...13	≥ 60 dB
Interferences by the parallel component of the d.c. and a.c. voltage: 50 and 100 Hz for a 50 Hz supply network 60 and 120 Hz for a 60 Hz supply network	100 V a.c. voltage 100 V d.c. voltage	01...13	≥ 90 dB

1) Resistances of leading wire connections should be equal. A difference of the resistances causes additional measuring error.

- **Admissible overload in the measuring system** acc. to EN 60051-8
- **Binary inputs:** 4 (or 8), with a common mass
 - control signal 0/5...24 V d.c.
 - switching frequency up to 50 Hz, (depending on equipment configuration)
 - isolation to the housing 500 V d.c.
- **Alarms**
- **Electromagnetic relays:** 6 (or 12), programmable
 - load capacity for resistance load AC max: 250 V a.c., 1 A
DC max: 30 V d.c., 1 A
- **Interfaces:**
 - RS-485 (Modbus Slave) baud rate: 300...256000 bit/s
transmission mode: ASCII/RTU
 - USB V.1.1 Device, Socket USBB-G
- **General recorder parameters:**
 - frontal face dimensions 144 x 144 mm
 - length behind the panel 155 mm
 - panel cut-out dimensions 138⁺¹ x 138⁺¹ mm
 - weight ca. 2 kg
 - tightening value of recorder mounting brackets 0.2 Nm

- colour graphical screen	LCD 5.7" of TFT type, 320 x 240 pixels with a touch screen
- external data carrier	CompactFlash up to 4GB
- memory of the internal buffer (flash)	6 MB
- working temperature	0... <u>23</u> ...50 °C
- related air humidity	< 75% (without condensation)
- supply voltage	90... <u>230</u> ...253 V a.c. or 18... <u>24</u> ...30 V d.c.
▪ Power consumption (max)	< 30 VA
▪ Protection of the power pack supply	Fuse RFS 1.6 A 250 V (for an a.c. supply)
▪ Housing protection class:	
- from frontal side	IP65, acc. to EN 60529
- from terminal side	IP20, acc. to EN 60529
▪ Operational safety:	acc. to EN 61010-1
- installation category	II
- pollution level	2
▪ Electromagnetic compatibility:	
- noise emissions	acc. to EN 61000-6-4
- noise immunity	acc. to EN 61000-6-2

11. ORDER CODES

SCREEN RECORDER KD8 -		X	X	X	XX	X
Measuring inputs:						
3 programmable measuring inputs	1					
6 programmable measuring inputs	2					
Alarms and measuring inputs:						
without alarms and binary inputs	0					
alarms + binary inputs ¹⁾	1					
Supply:						
supply 90...253V a.c.			1			
supply 18...30V d.c.			2			
Programs to service the recorder from a PC:						
Programs: KD Connect, KD Check				1		
Programs: KD Connect, KD Check, KD Archive, KD8 Setup				2		
Executions:						
standard					00	
custom-made ²⁾					XX	
Acceptance tests:						
without an extra quality inspection certificate						0
with an extra quality inspection certificate						1
according to user's agreements						2

- 1) For each 3 measuring inputs, a package with 6 alarms and 4 binary inputs is installed.
 2) After agreeing with the manufacturer

Accessories:

- 2 GB CF card0923-611-191
- 4 GB CF card0923-611-188

12. MAINTENANCE AND GUARANTEE

The KD8 recorder does not require any periodical maintenance.
In case of some incorrect operations:

1. After the dispatch date and within the period stated in the guarantee card

One should return the instrument to the Manufacturer's Quality Inspection Dept.
If the instrument has been used in compliance with the instructions, the
Manufacturer warrants to repair it free of charge.
The disassembling of the housing causes the cancellation of the granted guarantee.

2. After the guarantee period:

One should send the instrument to repair it in an authorized service workshop.
Spare parts are available for the period of five years from the date of purchase.

Our policy is one of continuous improvement and we reserve the right to make changes in design and specifications of any products as engineering advances or necessity requires and revise the above specifications without notice.



SALES PROGRAM

- DIGITAL and BARGRAPH PANEL METERS
- MEASURING TRANSDUCERS
- ANALOG PANEL METERS (DIN INSTRUMENTS)
- ANALOG and DIGITAL CLAMP-ON METERS
- PROCESS and HOUSEHOLD CONTROLLERS
- CHART AND PAPERLESS RECORDERS
- POWER CONTROL UNITS and SOLID-STATE RELAYS
- AUTOMOTIVE DASHBOARD INDICATORS
- 1-PHASE AND 3-PHASE WATT-HOUR METERS
- NUMERICAL AND ALPHANUMERICAL LARGE SIZE DISPLAYS
- ACCESSORIES FOR MEASURING INSTRUMENTS (SHUNTS AND MODULES)
- MEASURING SYSTEMS (ENERGY, HEAT, CONTROL)
- CUSTOM-MADE ELECTRONIC SUBASSEMBLIES ACC. TO ORDERS

WE ALSO OFFER OUR SERVICES IN THE PRODUCTION OF:

- ALUMINIUM ALLOY PRESSURE CASTINGS
- PRECISION ENGINEERING AND THERMOPLASTICS PARTS
- PRESSURE CASTING DIES AND OTHER TOOLS
- CUSTOM-MADE ELECTRONIC SUB-ASSEMBLIES

QUALITY PROCEDURES:

ACCORDING TO ISO 9001 AND ISO 14001 INTERNATIONAL REQUIREMENTS.
ALL OUR INSTRUMENTS HAVE CE MARK .

FOR MORE INFORMATION, PLEASE WRITE TO OR PHONE OUR EXPORT DEPARTMENT

KD8-09D/1

Lubuskie Zakłady Aparatów Elektrycznych - LUMEL S.A.
ul. Sulechowska 1
65-022 Zielona Góra – Poland

Tel.: (48-68) 32 95 1 00 (exchange)
Fax: (48-68) 32 95 1 01

e-mail: lumel@lumel.com.pl
<http://www.lumel.com.pl>

Export Department:

Tel.: (48-68) 329 53 02 or 53 04
Fax: (48-68) 325 40 91

e-mail: export@lumel.com.pl